



Fahrzeugbedarf
Division R.A.L. Handel

BELEUCHTUNG / LIGHTING

KATALOG 2016





FRONTBELEUCHTUNG /

FRONT LIGHTS

HAUPTSCHINWERFER /
HEAD LAMPS

6-54



ZUSATZSCHINWERFER /
ADDITIONAL LIGHTS

56-76



POSITIONSLEUCHTEN /
POSITION LAMPS

78-97



TAGFAHRLEUCHTEN /
DAYTIME RUNNING LIGHTS

99-100



BLINKLEUCHTEN /
INDICATOR LAMPS

102-106



HECKBELEUCHTUNG /

REAR LIGHTS

MEHRKAMMERLEUCHTEN /
MULTI-CHAMBER LIGHTS

108-212



KENNZEICHENLEUCHTEN /
LICENCE PLATE LAMPS

214-219



RÜCKFAHRSCHEINWERFER /
REVERSE LAMPS

221-228



NEBELSCHLUSSLEUCHTEN /
REAR FOG LAMPS

230-233



BREMSLEUCHTEN /
STOP LAMPS

235-236



POSITIONSLEUCHTEN /
POSITION LAMPS

238-245



BELEUCHTUNGSSÄTZE /
LIGHTING SETS

247-248



SEITENBELEUCHTUNG /
SIDE LIGHTS

SEITENMARKIERUNGSLEUCHTEN /
SIDE MARKER LAMPS

250-277



BLINKLEUCHTEN /
INDICATORS

279-308



BEGRENZUNGSLEUCHTEN /
MARKER LAMPS

310-334





SONDERLEUCHTEN /

SPECIAL LIGHTS

INNENBELEUCHTUNGEN /
INTERIOR LAMPS

336-346



LEUCHTMITTEL /

ILLUMINANTS

HALOGEN SCHEINWERFERLAMPEN /
HALOGEN LAMPS

348-351



ZUSATZSCHEINWERFERLAMPEN /
ADDITIONAL HEADLIGHT BULBS

352



GLÜHLAMPEN /
BULBS

353-358



LED LAMPEN /
LED BULBS

359-360



XENON LAMPEN /
XENON BULBS

361



ZUBEHÖR /
ACCESSORIES

362



HAUPTSCH EINWERFER

HEAD LAMPS





▪ **DAF 95
Hauptscheinwerfer**

Hauptscheinwerfer mit Blinker und
Positionsleuchte

▪ **DAF 95
head lamp**

Head lamp with indicator and position
lamp

OE- Nr. OE- No.	Leuchtmittel illuminant	Anbauseite installation side	Art.-Nr. Part No.
128 32 39 121 39 24	H4	◀ L	098 056 500
128 32 40 121 39 25	H4	▶ R	098 056 501

Zusatzartikel

Produktart product type	Artikeltitel article title	Glasfarbe glass colour	OE- Nr. OE- No.	Anbauseite installation side	Anschlussart connection type	Art.-Nr. Part No.
Blinkeleuchte indicator	Blinker indicator	gelb yellow	006 66 98 038 49 88			098 223 061
Streuscheiben lens	Streuscheibe lens		006 66 92	◀ L		098 109 700
Streuscheiben lens	Streuscheibe lens		006 66 93	▶ R		098 109 701
Stecker connector	KIT DAF XF 1995-2000 90°				AMP 1.5 90°	099 110 618



▪ **DAF 95 XF
Hauptscheinwerfer**

Hauptscheinwerfer mit Blinker und
Positionsluchte

▪ **DAF 95 XF
head lamp**

Head lamp with indicator and position
lamp

OE- Nr. OE- No.	Leuchtmittel illuminant	Anbauseite installation side	Art.-Nr. Part No.
129 33 60	H4	◀ L	098 056 502
129 33 61	H4	▶ R	098 056 503

Zusatzartikel

Produktart product type	Artikeltitel article title	Glasfarbe glass colour	OE- Nr. OE- No.	Anbauseite installation side	Anschlussart connection type	Art.-Nr. Part No.
Blinkeleuchte indicator	Blinker indicator	weiß white	130 13 68			098 223 060
Streuscheiben lens	Streuscheibe lens		131 81 49	◀ L		098 109 702
Streuscheiben lens	Streuscheibe lens		131 81 50	▶ R		098 109 703
Stecker connector	KIT DAF XF 1995-2000 90°				AMP 1.5 90°	099 110 618



▪ **DAF LF Serie 01>, CF Serie 03>
XF 105 / XC 105 06>
Hauptscheinwerfer**

Hauptscheinwerfer mit Blinker und
Positionsluchte

▪ **DAF LF Serie 01>, CF Serie 03>
XF 105 / XC 105 06>
head lamp**

Head lamp with indicator and position
lamp

OE- Nr. OE- No.	Leuchtmittel illuminant	Anbauseite installation side	Art.-Nr. Part No.
174 36 84	H1	◀ L	098 056 505
169 93 13	H7		
174 36 85	H1	▶ R	098 056 504
169 93 15	H7		

Zusatzartikel

Produktart product type	Artikeltitel article title	Glasfarbe glass colour	Anschlussart connection type	Art.-Nr. Part No.
Stecker connector	KIT DAF XF 1995-2000 90°		AMP 1.5 90°	099 110 618
Stecker connector	KIT JPT 2PK1			099 110 006
Streuscheiben lens	Streuscheibe lens	weiß white		098 109 710



▪ **DAF XF / CF 105 Euro 6
Hauptscheinwerfer**

Hauptscheinwerfer mit Blinker
Tagfahrlicht in LED

▪ **DAF XF / CF 105 Euro 6
head lamp**

Head lamp with indicator
Daytime running lamp in LED

OE- Nr. OE- No.	Leuchtmittel illuminant	Anbauseite installation side	Art.-Nr. Part No.
1835874	H1 H7 LED	◀ L	098 056 790
1835875	H1 H7 LED	▶ R	098 056 791



▪ **Iveco Eurocargo 91 - 04
Hauptscheinwerfer**

Hauptscheinwerfer mit Positionsleuchte
und Leuchtweitenregulierung

▪ **Iveco Eurocargo 91 - 04
head lamp**

Head lamp with position lamp and
levelling device

OE- Nr. OE- No.	Leuchtmittel illuminant	Anbauseite installation side	Art.-Nr. Part No.
500 340 408	H4	◀ L	198 054 315
500 340 361	H4	▶ R	198 054 316



▪ **Iveco Stralis II 08 > , Trakker II
Hauptscheinwerfer**

Hauptscheinwerfer mit Positionsleuchte
und Leuchtweitenregulierung

▪ **Iveco Stralis II 08 > , Trakker II
head lamp**

Head lamp with position lamp and
levelling device

OE- Nr. OE- No.	Leuchtmittel illuminant	Anbauseite installation side	Art.-Nr. Part No.
504 238 213 504 238 117	H7	◀ L	098 055 117
504 238 203 504 238 093	H7	▶ R	098 055 118

Zusatzartikel

Produktart product type	Artikeltitel article title	Art.-Nr. Part No.
Stecker connector	KIT SUPER SEAL	099 111 032
Stecker connector	KIT JPT 3PK1 DAF, Iveco	099 110 051



▪ **Iveco Eurotec, Eurostar
Hauptscheinwerfer**

Hauptscheinwerfer mit Positionsleuchte
und Leuchtweitenregulierung

▪ **Iveco Eurotec, Eurostar
head lamp**

Head lamp with position lamp and
levelling device

OE- Nr. OE- No.	Leuchtmittel illuminant	Anbauseite installation side	Art.-Nr. Part No.
500 305 103	H4 H3	◀ L	198 055 313
500 305 102 486 13 40	H4 H3	▶ R	198 055 314



▪ **Iveco Stralis I > 07 , Eurocargo 04 Hauptscheinwerfer**

Hauptscheinwerfer mit Positionsleuchte und Leuchtweitenregulierung

▪ **Iveco Stralis I > 07 , Eurocargo 04 head lamp**

Head lamp with position lamp and levelling device

OE- Nr. OE- No.	Leuchtmittel illuminant	Produktlinie product line	Anbauseite installation side	Art.-Nr. Part No.
504 020 193	H7	Eco^{Line}	◀ L	098 055 315
504 020 189	H7	Eco^{Line}	▶ R	098 055 316
504 020 193	H7	Premium^{Line}	◀ L	298 055 315
504 020 189	H7	Premium^{Line}	▶ R	298 055 316

Zusatzartikel

Produktart product type	Artikeltitel article title	Art.-Nr. Part No.
Stecker connector	KIT SUPER SEAL	099 111 032
Stecker connector	KIT JPT 3PK1 DAF, Iveco	099 110 051



▪ **Renault Trucks Kerax Hauptscheinwerfer**

Hauptscheinwerfer mit Positionsleuchte

▪ **Renault Trucks Kerax head lamp**

Head lamp with position lamp

OE- Nr. OE- No.	Leuchtmittel illuminant	Anbauseite installation side	Art.-Nr. Part No.
500 184 0476	H1	◀ L	198 106 974
500 184 0475	H1	▶ R	198 106 975



▪ **Renault Trucks Premium II
 Hauptscheinwerfer**

Hauptscheinwerfer mit
 Nebelscheinwerfer, Blinker und
 Positionsleuchte.
 Chrom

▪ **Renault Trucks Premium II
 head lamp**

Head lamp with fog lamp, indicator and
 position lamp.
 Chrome

OE- Nr. OE- No.	Leuchtmittel illuminant	Anbauseite installation side	Art.-Nr. Part No.
501 057 8451 742 163 6295 501 057 854	H1 H3 H7	◀ L	198 083 001
501 057 8475 742 163 6309 501 057 8478	H1 H3 H7	▶ R	198 083 002

Zusatzartikel

Produktart product type	Artikeltitel article title	Anbauseite installation side	Art.-Nr. Part No.
Streuscheiben lens	Streuscheibe lens	◀ L	098 109 708
Streuscheiben lens	Streuscheibe lens	▶ R	098 109 709



▪ **Renault Trucks Premium / Kerax
 Hauptscheinwerfer**

Hauptscheinwerfer mit Positionsleuchte

▪ **Renault Trucks Premium / Kerax
 head lamp**

Head lamp with position lamp and
 indicator

OE- Nr. OE- No.	Leuchtmittel illuminant	Anbauseite installation side	Art.-Nr. Part No.
501 037 9321	H1	◀ L	098 106 976
501 037 9320	H1	▶ R	098 106 977

Zusatzartikel

Produktart product type	Artikeltitel article title	Glasfarbe glass colour	OE- Nr. OE- No.	Anbauseite installation side	Art.-Nr. Part No.
Blinkeleuchte indicator	Blinker indicator	weiß white	500 183 4560	◀ L	098 222 400
Blinkeleuchte indicator	Blinker indicator	weiß white	500 183 4559	▶ R	098 222 410



FRONTBELEUCHTUNG
FRONT LIGHTS



Renault Trucks Premium II Hauptscheinwerfer

Hauptscheinwerfer Xenon mit Blinker, Positionsleuchte und Nebelscheinwerfer, Chrom

Renault Trucks Premium II head lamp

Head lamp Xenon with indicator, position lamp and fog lamp, chrome

Leuchtmittel illuminant	Anbauseite installation side	Art.-Nr. Part No.
Xenon D1S H1	◀ L	198 083 007
Xenon D1S H1	▶ R	198 083 008

Zusatzartikel

Produktart product type	Artikeltitel article title	Anbauseite installation side	Art.-Nr. Part No.
Streuscheiben lens	Streuscheibe lens	◀ L	098 109 708
Streuscheiben lens	Streuscheibe lens	▶ R	098 109 709



Renault Trucks Midliner Hauptscheinwerfer

Hauptscheinwerfer mit Positionsleuchte

Renault Trucks Midliner head lamp

Head lamp with position lamp

OE- Nr. OE- No.	Leuchtmittel illuminant	Anbauseite installation side	Art.-Nr. Part No.
500 183 4613 500 101 3951	H4	◀ L	098 084 382
500 183 4614 500 101 3952	H4	▶ R	098 084 383



Renault Trucks Midlum Hauptscheinwerfer

Hauptscheinwerfer mit Positionsleuchte

Renault Trucks Midlum head lamp

Head lamp with position lamp

OE- Nr. OE- No.	Leuchtmittel illuminant	Anbauseite installation side	Art.-Nr. Part No.
500 185 3978	H1	▶ R	098 089 290
500 185 3979	H1	◀ L	098 089 291



▪ **Renault Trucks Magnum AE
 Hauptscheinwerfer**

Hauptscheinwerfer mit Positionslampe

▪ **Renault Trucks Magnum AE
 head lamp**

Head lamp with position lamp

OE- Nr. OE- No.	Leuchtmittel illuminant	Art.-Nr. Part No.
501 023 1111	H4	098 069 715



▪ **Renault Trucks Magnum AE
 Hauptscheinwerfer**

Hauptscheinwerfer ohne Positionslampe

▪ **Renault Trucks Magnum AE
 head lamp**

Head lamp without position lamp

OE- Nr. OE- No.	Leuchtmittel illuminant	Art.-Nr. Part No.
501 023 1112	H4	098 069 716



▪ **Renault Trucks Magnum E-Tech
Hauptscheinwerfer**

Hauptscheinwerfer mit
Nebelscheinwerfer und Positionleuchte

▪ **Renault Trucks Magnum E-Tech
head lamp**

Head lamp with fog lamp and position
lamp

OE- Nr. OE- No.	Leuchtmittel illuminant	Anbauseite installation side	Art.-Nr. Part No.
501 062 3620 501 054 4979 501 048 3121	H1 H7	◀ L	098 083 005
501 062 3619 501 054 4978 501 048 0320	H1 H7	▶ R	098 083 006

Zusatzartikel

Produktart product type	Artikeltitel article title	OE- Nr. OE- No.	Anbauseite installation side	Art.-Nr. Part No.
Streuscheiben lens	Streuscheibe lens	1ER 246 046-511	◀ L	098 109 704
Streuscheiben lens	Streuscheibe lens	1ER 246 046-521	▶ R	098 109 705



▪ **MAN F 2000
Hauptscheinwerfer**

Hauptscheinwerfer mit Blinker und
Positionsbeleuchtung

▪ **MAN F 2000
head lamp**

Head lamp with indicator and position
lamp

OE- Nr. OE- No.	Leuchtmittel illuminant	Anbauseite installation side	Art.-Nr. Part No.
81.25101.6289	H7	◀ L	198 018 289
81.25101.6290	H7	▶ R	198 018 290

Zusatzartikel

Produktart product type	Artikeltitel article title	Glasfarbe glass colour	OE- Nr. OE- No.	Anbauseite installation side	Art.-Nr. Part No.
Blinkeleuchte indicator	Blinker indicator	gelb yellow	81.25320.6084		098 222 805
Streuscheiben lens	Streuscheibe Lens	weiß white	81.25110.0067	◀ L	198 109 867
Streuscheiben lens	Streuscheibe Lens	weiß white	81.25110.0068	▶ R	198 109 868





▪ **MAN F 2000
Hauptscheinwerfer**

Hauptscheinwerfer mit Blinker,
Positionsbeleuchtung und
Leuchtweitenregulierung

▪ **MAN F 2000
head lamp**

Head lamp with indicator, position lamp
and levelling device

OE- Nr. OE- No.	Leuchtmittel illuminant	Produktlinie product line	Anbauseite installation side	Art.-Nr. Part No.
81.25101.6291	H7		◀ L	398 018 291
81.25101.6292	H7		▶ R	398 018 292

Zusatzartikel

Produktart product type	Artikeltitel article title	Glasfarbe glass colour	OE- Nr. OE- No.	Anbauseite installation side	Art.-Nr. Part No.
Blinkeleuchte indicator	Blinker indicator	gelb yellow	81.25320.6084		098 222 805
Streuscheiben lens	Streuscheibe Lens	weiß white	81.25110.0067	◀ L	198 109 867
Streuscheiben lens	Streuscheibe Lens	weiß white	81.25110.0068	▶ R	198 109 868



- MAN TGA / TGL / TGM / LE 2000 / Bus
Hauptscheinwerfer
- MAN TGA / TGL / TGM / LE 2000 / Bus
head lamp

Hauptscheinwerfer mit
Positionsb e leuchtung

Head lamp with position lamp

OE- Nr. OE- No.	Leuchtmittel illuminant	Produktlinie product line	Anbauseite installation side	Art.-Nr. Part No.
81.25101-6578 81.25101-6449 81.25101-6419 81.25101-6427 81.25101-6347	H7	Line Eco	◀ L	198 018 347
81.25101-6577 81.25101-6448 81.25101-6348 81.25101-6420 81.25101-6428	H7	Line Eco	▶ R	198 018 348
81.25101-6578 81.25101-6449 81.25101-6419 81.25101-6427 81.25101-6347	H7	Line Premium	◀ L	298 018 347
81.25101-6577 81.25101-6448 81.25101-6348 81.25101-6420 81.25101-6428	H7	Line Premium	▶ R	298 018 348

Zusatzartikel

Produktart product type	Artikeltitel article title	Glasfarbe glass colour	OE- Nr. OE- No.	Anbauseite installation side	Anschlussart connection type	Art.-Nr. Part No.
Streuscheiben lens	Streuscheibe Lens	weiß white	81.25110-0080	◀ L		198 109 880
Streuscheiben lens	Streuscheibe Lens	weiß white	81.25110-0081	▶ R		198 109 881
Stecker connector	KIT MAN TG-A NW 8,5 gerade				AMP 1.5 180°	099 111 648



- **MAN TGA / TGL / TGM / LE 2000 / Bus** **Hauptscheinwerfer**
- **MAN TGA / TGL / TGM / LE 2000 / Bus** **head lamp**

Hauptscheinwerfer mit Positionsbeleuchtung und Leuchtweitenregulierung

Head lamp with position lamp and levelling device

OE- Nr. OE- No.	Leuchtmittel illuminant	Produktlinie product line	Anbauseite installation side	Art.-Nr. Part No.
81.25101-6580 81.25101-6451 81.25101-6351 81.25101-6421	H7	Line Eco	◀ L	198 018 351
81.25101-6579 81.25101-6450 81.25101-6352 81.25101-6422	H7	Line Eco	▶ R	198 018 352
81.25101-6580 81.25101-6451 81.25101-6351 81.25101-6421	H7	Premium Line	◀ L	298 018 351
81.25101-6579 81.25101-6450 81.25101-6352 81.25101-6422	H7	Premium Line	▶ R	298 018 352
81.25101-6473 81.25101-6361	Xenon D2R		◀ L	098 018 361
81.25101-6472 81.25101-6360	Xenon D2R		▶ R	098 018 360

Zusatzartikel

Produktart product type	Artikeltitel article title	Glasfarbe glass colour	OE- Nr. OE- No.	Anbauseite installation side	Anschlussart connection type	Art.-Nr. Part No.
Streuscheiben lens	Streuscheibe Lens	weiß white	81.25110-0080	◀ L		198 109 880
Streuscheiben lens	Streuscheibe Lens	weiß white	81.25110-0081	▶ R		198 109 881
Stecker connector	KIT MAN TG-A NW 8,5 gerade				AMP 1.5 180°	099 111 648



MAN TGX 2007 >
Hauptscheinwerfer

Hauptscheinwerfer mit
Positionsbeleuchtung, Tagfahrlicht und
Leuchtweitenregulierung

MAN TGX 2007 >
head lamp

Head lamp with position lamp, daytime
running lamp and levelling device

OE- Nr. OE- No.	Leuchtmittel illuminant	Produktlinie product line	Anbauseite installation side	Art.-Nr. Part No.
81.25101-6663 81.25101-6503	H7	Premium ^{Line}	◀ L	298 018 206
81.25101-6664 81.25101-6504	H7	Premium ^{Line}	▶ R	298 018 207
	Xenon D1R	Premium ^{Line}	▶ R	298 018 211
	Xenon D1R	Premium ^{Line}	◀ L	298 018 210

Zusatzartikel

Produktart product type	Artikeltitel article title	Glasfarbe glass colour	OE- Nr. OE- No.	Anbauseite installation side	Art.-Nr. Part No.
Streuscheiben lens	Streuscheibe lens	weiß white	81.25110-0085	◀ L	198 109 885
Streuscheiben lens	Streuscheibe lens	weiß white	81.25110-0086	▶ R	198 109 886
Streuscheiben lens	Streuscheibe lens	weiß white	81.25110-0085	◀ L	398 109 885
Streuscheiben lens	Streuscheibe lens	weiß white	81.25110-0086	▶ R	398 109 886

INFORMIEREN SIE SICH
AUCH ÜBER UNSEREN
FAHRZEUGAUSRÜSTUNGSKATALOG

WWW.RAL.AT







▪ **MAN TGX 2007 > Hauptscheinwerfer**

Hauptscheinwerfer mit Positionsbeleuchtung und Leuchtweitenregulierung

▪ **MAN TGX 2007 > head lamp**

Head lamp with position lamp and levelling device

OE- Nr. OE- No.	Leuchtmittel illuminant	Produktlinie product line	Anbauseite installation side	Art.-Nr. Part No.
81.25101-6659 81.25101-6499	H7		◀ L	398 018 204
81.25101-6660 81.25101-6498	H7		▶ R	398 018 205

Zusatzartikel

Produktart product type	Artikeltitel article title	Glasfarbe glass colour	OE- Nr. OE- No.	Anbauseite installation side	Art.-Nr. Part No.
Streuscheiben lens	Streuscheibe lens	weiß white	81.25110-0085	◀ L	198 109 885
Streuscheiben lens	Streuscheibe lens	weiß white	81.25110-0086	▶ R	198 109 886
Streuscheiben lens	Streuscheibe lens	weiß white	81.25110-0085	◀ L	398 109 885
Streuscheiben lens	Streuscheibe lens	weiß white	81.25110-0086	▶ R	398 109 886





▪ **MAN TGX 2007 > Hauptscheinwerfer**

Hauptscheinwerfer mit Positionsbeleuchtung und Tagfahrlicht

▪ **MAN TGX 2007 > head lamp**

Head lamp with position lamp and daytime running lamp

OE- Nr. OE- No.	Leuchtmittel illuminant	Produktlinie product line	Anbauseite installation side	Art.-Nr. Part No.
81.25101-6661 81.25101-6501	H7		◀ L	398 018 202
81.25101-6662 81.25101-6500	H7		▶ R	398 018 203

Zusatzartikel

Produktart product type	Artikeltitel article title	Glasfarbe glass colour	OE- Nr. OE- No.	Anbauseite installation side	Art.-Nr. Part No.
Streuscheiben lens	Streuscheibe lens	weiß white	81.25110-0085	◀ L	198 109 885
Streuscheiben lens	Streuscheibe lens	weiß white	81.25110-0086	▶ R	198 109 886
Streuscheiben lens	Streuscheibe lens	weiß white	81.25110-0085	◀ L	398 109 885
Streuscheiben lens	Streuscheibe lens	weiß white	81.25110-0086	▶ R	398 109 886



FRONTBELEUCHTUNG
FRONT LIGHTS



▪ **MAN TGX 2007 > Hauptscheinwerfer**

Hauptscheinwerfer mit Positionsbeleuchtung

▪ **MAN TGX 2007 > head lamp**

Head lamp with position lamp

OE- Nr. OE- No.	Leuchtmittel illuminant	Produktlinie product line	Anbauseite installation side	Art.-Nr. Part No.
81.25101-6658 81.25101-6496	H7		▶ R	398 018 201
81.25101-6657 81.25101-6497	H7		◀ L	398 018 200

Zusatzartikel

Produktart product type	Artikeltitel article title	Glasfarbe glass colour	OE- Nr. OE- No.	Anbauseite installation side	Art.-Nr. Part No.
Streuscheiben lens	Streuscheibe lens	weiß white	81.25110-0085	◀ L	198 109 885
Streuscheiben lens	Streuscheibe lens	weiß white	81.25110-0086	▶ R	198 109 886
Streuscheiben lens	Streuscheibe lens	weiß white	81.25110-0085	◀ L	398 109 885
Streuscheiben lens	Streuscheibe lens	weiß white	81.25110-0086	▶ R	398 109 886



▪ **Scania P / G / R Serie 08 > Hauptscheinwerfer**

Tagfahrleuchte, sehr helle LED der neuesten Generation

▪ **Scania P / G / R Serie 08 > head lamp**

New generation super bright LED's

Anschlussspannung connection voltage	OE- Nr. OE- No.	Leuchtmittel illuminant	Anbauseite installation side	Art.-Nr. Part No.
9-33 V	1931613	LED	◀ L	298 055 613
9-33 V	1931614	LED	▶ R	298 055 614

Zusatzartikel

Produktart product type	Artikeltitel article title	Art.-Nr. Part No.
Stecker connector	KIT SUPER SEAL	099 110 019



▪ Scania P / G / R 08 >
Hauptscheinwerfer

Hauptscheinwerfer Xenon mit
Positionsleuchte und integriertem
Steuergerät

▪ Scania P / G / R 08 >
head lamp

Head lamp Xenon with position lamp

OE- Nr. OE- No.	Leuchtmittel illuminant	Anbauseite installation side	Art.-Nr. Part No.
1 760 551	Xenon D2R H7	◀ L	198 103 130
1 760 554	Xenon D2R H7	▶ R	198 103 140

Zusatzartikel

Produktart product type	Artikeltitel article title	Glasfarbe glass colour	OE- Nr. OE- No.	Anbauseite installation side	Art.-Nr. Part No.
Streuscheiben lens	Streuscheibe lens	weiß white	1549814 1521565	◀ L	098 109 980
Streuscheiben lens	Streuscheibe lens	weiß white	1549815 1521566	▶ R	098 109 981



▪ Scania 4, P / G / R / T 04 >
Hauptscheinwerfer

Hauptscheinwerfer mit Blink-,
Positionsleuchte und Anschlusskabel

▪ Scania 4, P / G / R / T 04 >
head lamp

Head lamp with indicator, position lamp
and connection wire

OE- Nr. OE- No.	Leuchtmittel illuminant	Anbauseite installation side	Art.-Nr. Part No.
1 732 509 1 467 000	H4	◀ L	198 103 110
1 732 510 1 467 003	H4	▶ R	198 103 120

Zusatzartikel

Produktart product type	Artikeltitel article title	OE- Nr. OE- No.	Anbauseite installation side	Art.-Nr. Part No.
Streuscheiben lens	Streuscheibe lens	1 446 583	◀ L	098 109 965
Streuscheiben lens	Streuscheibe lens	1 446 584	▶ R	098 109 966
Anschlusskabel connection wire	Anschlusskabel mit Fassung connection wire with holder	1 732 515 1 467 007 1 385 411		098 109 969



▪ Scania P / G / R 08 >
Hauptscheinwerfer

Hauptscheinwerfer mit Positionsleuchte

▪ Scania P / G / R 08 >
head lamp

Head lamp with position lamp

Leuchtmittel illuminant	Anbauseite installation side	Art.-Nr. Part No.
H7	◀ L	198 103 150
H7	▶ R	198 103 160

Zusatzartikel

Produktart product type	Artikeltitel article title	Glasfarbe glass colour	OE- Nr. OE- No.	Anbauseite installation side	Art.-Nr. Part No.
Streuscheiben lens	Streuscheibe lens	weiß white	1549814 1521565	◀ L	098 109 980
Streuscheiben lens	Streuscheibe lens	weiß white	1549815 1521566	▶ R	098 109 981



▪ Volvo FH 93 - 97
Hauptscheinwerfer

Hauptscheinwerfereinsatz

▪ Volvo FH 93 - 97
head lamp

head lamp unit

OE- Nr. OE- No.	Leuchtmittel illuminant	Art.-Nr. Part No.
8144286 3981594	H4	098 103 325



▪ **Volvo F / FL / FS 10, 12, 16
 Hauptscheinwerfer**

Hauptscheinwerfereinsatz

▪ **Volvo F / FL / FS 10, 12, 16
 head lamp**

head lamp unit

OE- Nr. OE- No.	Leuchtmittel illuminant	Art.-Nr. Part No.
3175032 1597083 1081607 1594083	H4	098 103 315



▪ **Volvo FH, FM, 97 - 01
 Hauptscheinwerfer**

Hauptscheinwerfereinsatz

▪ **Volvo FH, FM, 97 - 01
 head lamp**

head lamp unit

OE- Nr. OE- No.	Leuchtmittel illuminant	Art.-Nr. Part No.
8144287 3981594	H4	098 103 330



▪ **Volvo FM II, FH II 02 - 08
Hauptscheinwerfer**

Hauptscheinwerfer mit Positionsleuchte, Blinker, Fern- und Nebelscheinwerfer. Auch für Leuchtweitenregulierung verwendbar. Anschlussstecker rund.

▪ **Volvo FM II, FH II 02 - 08
head lamp**

Head lamp with position lamp, indicator, driving lamp and fog lamp. Also levelling device used. connector round.

OE- Nr. OE- No.	Leuchtmittel illuminant	Anbauseite installation side	Art.-Nr. Part No.
21001663 20861583	H7	◀ L	098 082 001
21001668 20861584	H7	▶ R	098 082 002

Zusatzartikel

Produktart product type	Artikeltitel article title	Glasfarbe glass colour	OE- Nr. OE- No.	Anbauseite installation side	Art.-Nr. Part No.
Adapter adapter	Adapterleitung für neue Hauptscheinwerferausführung Volvo FH ab 2007>				098 291 005
Streuscheiben lens	Streuscheibe lens	weiß white	20710524 20379428	◀ L	098 110 001
Streuscheiben lens	Streuscheibe lens	weiß white	20710525 20379429	▶ R	098 110 002
Montageteile mounting hardware	Einbaurahmen holder		20452847	◀ L	098 110 003
Montageteile mounting hardware	Einbaurahmen holder		20452848	▶ R	098 110 004





▪ **Volvo FM II, FH II 02 - 08
Hauptscheinwerfer**

Hauptscheinwerfer mit Positionsleuchte, Blinker, Fern- und Nebelscheinwerfer. Auch für Leuchtweitenregulierung verwendbar. Anschlussstecker eckig.

▪ **Volvo FM II, FH II 02 - 08
head lamp**

Head lamp with position lamp, indicator, driving lamp and fog lamp. Also levelling device used. connector square.

OE- Nr. OE- No.	Leuchtmittel illuminant	Produktlinie product line	Anbauseite installation side	Art.-Nr. Part No.
20360898	H7		◀ L	098 082 005
20360899	H7		▶ R	098 082 006

Zusatzartikel

Produktart product type	Artikeltitel article title	Glasfarbe glass colour	OE- Nr. OE- No.	Anbauseite installation side	Art.-Nr. Part No.
Adapter adapter	Adapterleitung für neue Hauptscheinwerferausführung Volvo FH ab 2007>				098 291 005
Streuscheiben lens	Streuscheibe lens	weiß white	20710524 20379428	◀ L	098 110 001
Streuscheiben lens	Streuscheibe lens	weiß white	20710525 20379429	▶ R	098 110 002
Montageteile mounting hardware	Einbaurahmen holder		20452847	◀ L	098 110 003
Montageteile mounting hardware	Einbaurahmen holder		20452848	▶ R	098 110 004



▪ **Volvo FM II, FH II 02 - 08
Hauptscheinwerfer**

Hauptscheinwerfer mit Positionsleuchte, Blinker, Fern- und Nebelscheinwerfer. Auch für Leuchtweitenregulierung verwendbar. Anschlussstecker eckig.

▪ **Volvo FM II, FH II 02 - 08
head lamp**

Head lamp with position lamp, indicator, driving lamp and fog lamp. Also levelling device used. connector square.

OE- Nr. OE- No.	Leuchtmittel illuminant	Produktlinie product line	Anbauseite installation side	Art.-Nr. Part No.
20360898	H7	Premium ^{Line}	◀ L	298 082 005
20360899	H7	Premium ^{Line}	▶ R	298 082 006

Zusatzartikel

Produktart product type	Artikeltitel article title	Glasfarbe glass colour	OE- Nr. OE- No.	Anbauseite installation side	Art.-Nr. Part No.
Adapter adapter	Adapterleitung für neue Hauptscheinwerferausführung Volvo FH ab 2007>				098 291 005
Streuscheiben lens	Streuscheibe lens	weiß white	20710524 20379428	◀ L	098 110 001
Streuscheiben lens	Streuscheibe lens	weiß white	20710525 20379429	▶ R	098 110 002
Montageteile mounting hardware	Einbaurahmen holder		20452847	◀ L	098 110 003
Montageteile mounting hardware	Einbaurahmen holder		20452848	▶ R	098 110 004



▪ **Volvo FM II, FH II 02 - 08
Hauptscheinwerfer**

Hauptscheinwerfer Xenon mit Positionsleuchte, Blinker, Fern- und Nebelscheinwerfer. Auch für Leuchtweitenregulierung verwendbar. Anschlussstecker rund.

▪ **Volvo FM II, FH II 02 - 08
head lamp**

Head lamp Xenon with position lamp, indicator, driving lamp and fog lamp. Also levelling device used. connector round

FRONTBELEUCHTUNG
FRONT LIGHTS

OE- Nr. OE- No.	Leuchtmittel illuminant	Produktlinie product line	Anbauseite installation side	Art.-Nr. Part No.
21001650	Xenon D2R	Premium ^{Line}	◀ L	298 082 003
21001651	Xenon D2R	Premium ^{Line}	▶ R	298 082 004

Zusatzartikel

Produktart product type	Artikeltitel article title	Glasfarbe glass colour	OE- Nr. OE- No.	Anbauseite installation side	Art.-Nr. Part No.
Adapter adapter	Adapterleitung für neue Hauptscheinwerferausführung Volvo FH ab 2007>				098 291 005
Streuscheiben lens	Streuscheibe lens	weiß white	20710524 20379428	◀ L	098 110 001
Streuscheiben lens	Streuscheibe lens	weiß white	20710525 20379429	▶ R	098 110 002
Montageteile mounting hardware	Einbaurahmen holder		20452847	◀ L	098 110 003
Montageteile mounting hardware	Einbaurahmen holder		20452848	▶ R	098 110 004



Volvo FL II, FE II 06 > Hauptscheinwerfer

Hauptscheinwerfer mit Positionsleuchte und Blinker

Volvo FL II, FE II 06 > head lamp

Head lamp with position lamp and indicator lamp

OE- Nr. OE- No.	Leuchtmittel illuminant	Anbauseite installation side	Art.-Nr. Part No.
20818765 20818763	H4	L	098 082 010
20818775 20818771	H4	R	098 082 012

BEACHTEN SIE UNSERE LAUFENDEN AKTIONEN IN UNSEREN FILIALEN UND AUF

WWW.RAL.AT



Besuchen Sie uns auf unserer Homepage www.ral.at



▪ **Volvo FM III, FH III 08 >**
Hauptscheinwerfer

Hauptscheinwerfer mit Tagfahrlicht LED

▪ **Volvo FM III, FH III 08 >**
head lamp

Head lamp with daytime running light LED

FRONTBELEUCHTUNG
 FRONT LIGHTS

OE- Nr. OE- No.	Leuchtmittel illuminant	Anbauseite installation side	Art.-Nr. Part No.
82304599 21323108 21035638 21123523	H7	◀ L	298 082 007
82304585 21323106 21035637 21123489	H7	▶ R	298 082 008

Zusatzartikel

Produktart product type	Artikeltitel article title	Glasfarbe glass colour	Anbauseite installation side	Art.-Nr. Part No.
Streuscheiben lens	Streuscheibe lens	weiß white	◀ L	098 110 005
Streuscheiben lens	Streuscheibe lens	weiß white	▶ R	098 110 006



▪ Volvo FM III, FH III 08 >
Hauptscheinwerfer

Hauptscheinwerfer mit Tagfahrlicht LED

▪ Volvo FM III, FH III 08 >
head lamp

Head lamp with daytime running light
LED

OE- Nr. OE- No.	Leuchtmittel illuminant	Produktlinie product line	Anbauseite installation side	Art.-Nr. Part No.
21035645	Xenon D2S H7 LED	Line Eco	◀ L	098 082 009
21035644	Xenon D2S H7 LED	Line Eco	▶ R	098 082 011
21035645	Xenon D2S H7 LED	Line Premium	◀ L	298 082 009
21035644	Xenon D2S H7 LED	Line Premium	▶ R	298 082 011

Zusatzartikel

Produktart product type	Artikeltitel article title	Glasfarbe glass colour	Anbauseite installation side	Art.-Nr. Part No.
Streuscheiben lens	Streuscheibe lens	weiß white	◀ L	098 110 005
Streuscheiben lens	Streuscheibe lens	weiß white	▶ R	098 110 006



▪ **MB Actros I
 Hauptscheinwerfer**

Hauptscheinwerfer mit
 Positionsbeleuchtung

▪ **MB Actros I
 head lamp**

Head lamp with position lamp

OE- Nr. OE- No.	Leuchtmittel illuminant	Anbauseite installation side	Art.-Nr. Part No.
941 820 5761 941 820 3961	H4	◀ L	098 081 117
941 820 5861 941 820 4061	H4	▶ R	098 081 118

Zusatzartikel

Produktart product type	Artikeltitel article title	Glasfarbe glass colour	OE- Nr. OE- No.	Anbauseite installation side	Anschlussart connection type	Anbauwinkel mounting bracket	Art.-Nr. Part No.
Streuscheiben lens	Streuscheibe lens	weiß white	004 826 2590 004 826 0690	◀ L			198 109 834
Streuscheiben lens	Streuscheibe lens	weiß white	004 826 2690 004 826 0790	▶ R			198 109 835
Montageteile mounting hardware	Umbausatz für Streuscheibe Repair kit lens		000 826 7284				098 109 093
Stecker connector	KIT NW 8,5 MB Actros, MB Axor gerade				AMP 1.5 180°	180	099 110 620



FRONTBELEUCHTUNG
FRONT LIGHTS



▪ **MB Actros I
Hauptscheinwerfer**

Hauptscheinwerfer mit
Positionsbeleuchtung und
Leuchtweitenregulierung

▪ **MB Actros I
head lamp**

Head lamp with position lamp and
levelling device

OE- Nr. OE- No.	Leuchtmittel illuminant	Anbauseite installation side	Art.-Nr. Part No.
941 820 6161	H4	◀ L	198 081 317
941 820 6261	H4	▶ R	198 081 318

Zusatzartikel

Produktart product type	Artikeltitel article title	Glasfarbe glass colour	OE- Nr. OE- No.	Anbauseite installation side	Anschlussart connection type	Anbauwinkel mounting bracket	Art.-Nr. Part No.
Streuscheiben lens	Streuscheibe lens	weiß white	004 826 2590 004 826 0690	◀ L			198 109 834
Streuscheiben lens	Streuscheibe lens	weiß white	004 826 2690 004 826 0790	▶ R			198 109 835
Montageteile mounting hardware	Umbausatz für Streuscheibe Repair kit lens		000 826 7284				098 109 093
Stecker connector	KIT NW 8,5 MB Actros, MB Axor gerade				AMP 1.5 180°	180	099 110 620



▪ **MB Actros I
Hauptscheinwerfer**

Hauptscheinwerfer mit Blinker,
Positionsbeleuchtung

▪ **MB Actros I
head lamp**

Head lamp with indicator and position
lamp

FRONTBELEUCHTUNG
FRONT LIGHTS

OE- Nr. OE- No.	Leuchtmittel illuminant	Anbauseite installation side	Art.-Nr. Part No.
941 820 5361 941 820 2761	H4	◀ L	198 081 119
941 820 5461 941 820 2861	H4	▶ R	198 081 120

Zusatzartikel

Produktart product type	Artikeltitel article title	Glasfarbe glass colour	OE- Nr. OE- No.	Anbauseite installation side	Anschlussart connection type	Anbauwinkel mounting bracket	Art.-Nr. Part No.
Streuscheiben lens	Streuscheibe lens	weiß white	004 826 2590 004 826 0690	◀ L			198 109 834
Streuscheiben lens	Streuscheibe lens	weiß white	004 826 2690 004 826 0790	▶ R			198 109 835
Montageteile mounting hardware	Umbausatz für Streuscheibe Repair kit lens		000 826 7284				098 109 093
Stecker connector	KIT NW 8,5 MB Actros, MB Axor gerade				AMP 1.5 180°	180	099 110 620



▪ **MB Actros I
Hauptscheinwerfer**

Hauptscheinwerfer mit Blinker,
Positionsbeleuchtung und
Leuchtweitenregulierung

▪ **MB Actros I
head lamp**

Head lamp with indicator, position lamp
and levelling device

OE- Nr. OE- No.	Leuchtmittel illuminant	Anbauseite installation side	Art.-Nr. Part No.
941 820 5561 941 820 2961	H4	◀ L	198 081 321
941 820 5661 941 820 3061	H4	▶ R	198 081 322

Zusatzartikel

Produktart product type	Artikeltitel article title	Glasfarbe glass colour	OE- Nr. OE- No.	Anbauseite installation side	Anschlussart connection type	Anbauwinkel mounting bracket	Art.-Nr. Part No.
Streuscheiben lens	Streuscheibe lens	weiß white	004 826 2590 004 826 0690	◀ L			198 109 834
Streuscheiben lens	Streuscheibe lens	weiß white	004 826 2690 004 826 0790	▶ R			198 109 835
Montageteile mounting hardware	Umbausatz für Streuscheibe Repair kit lens		000 826 7284				098 109 093
Stecker connector	KIT NW 8,5 MB Actros, MB Axor gerade				AMP 1.5 180°	180	099 110 620



▪ **MB Actros I
 Hauptscheinwerfer**

Hauptscheinwerfer mit
 Positionsbeleuchtung und
 Nebelscheinwerfer

▪ **MB Actros I
 head lamp**

Head lamp with position lamp and fog
 lamp

OE- Nr. OE- No.	Leuchtmittel illuminant	Anbauseite installation side	Art.-Nr. Part No.
941 820 5161	H1 H4	◀ L	198 081 121
941 820 5261	H1 H4	▶ R	198 081 122

Zusatzartikel

Produktart product type	Artikeltitel article title	Glasfarbe glass colour	OE- Nr. OE- No.	Anbauseite installation side	Anschlussart connection type	Anbauwinkel mounting bracket	Art.-Nr. Part No.
Streuscheiben lens	Streuscheibe lens	weiß white	004 826 2590 004 826 0690	◀ L			198 109 834
Streuscheiben lens	Streuscheibe lens	weiß white	004 826 2690 004 826 0790	▶ R			198 109 835
Montageteile mounting hardware	Umbausatz für Streuscheibe Repair kit lens		000 826 7284				098 109 093
Stecker connector	KIT NW 8,5 MB Actros, MB Axor gerade				AMP 1.5 180°	180	099 110 620



▪ **MB Actros I
Hauptscheinwerfer**

Hauptscheinwerfer mit
Positionsbeleuchtung,
Nebelscheinwerfer und
Leuchtweitenregulierung

▪ **MB Actros I
head lamp**

*Head lamp with position lamp and
fog lamp and levelling device*

OE- Nr. OE- No.	Leuchtmittel illuminant	Anbauseite installation side	Art.-Nr. Part No.
941 820 4361	H1 H4	◀ L	198 081 319
941 820 4461	H1 H4	▶ R	198 081 320

Zusatzartikel

Produktart product type	Artikeltitel article title	Glasfarbe glass colour	OE- Nr. OE- No.	Anbauseite installation side	Anschlussart connection type	Anbauwinkel mounting bracket	Art.-Nr. Part No.
Streuscheiben lens	Streuscheibe lens	weiß white	004 826 2590 004 826 0690	◀ L			198 109 834
Streuscheiben lens	Streuscheibe lens	weiß white	004 826 2690 004 826 0790	▶ R			198 109 835
Montageteile mounting hardware	Umbausatz für Streuscheibe Repair kit lens		000 826 7284				098 109 093
Stecker connector	KIT NW 8,5 MB Actros, MB Axor gerade				AMP 1.5 180°	180	099 110 620



▪ **MB Actros II
 Hauptscheinwerfer**

Hauptscheinwerfer mit Blinker

▪ **MB Actros II
 head lamp**

Head lamp with indicator

OE- Nr. OE- No.	Leuchtmittel illuminant	Produktlinie product line	Anbauseite installation side	Art.-Nr. Part No.
943 820 0161	H1 H7	Eco^{Line}	◀ L	198 081 161
943 820 0261	H1 H7	Eco^{Line}	▶ R	198 081 261
943 820 0161	H1 H7	Premium^{Line}	◀ L	298 081 161
943 820 0261	H1 H7	Premium^{Line}	▶ R	298 081 261

Zusatzartikel

Produktart product type	Artikeltitel article title	Glasfarbe glass colour	Anbauseite installation side	Anschlussart connection type	Anbauwinkel mounting bracket	Art.-Nr. Part No.
Streuscheiben lens	Streuscheibe lens	weiß white	◀ L			198 109 832
Streuscheiben lens	Streuscheibe lens	weiß white	▶ R			198 109 833
Stecker connector	KIT NW 8,5 MB Actros, MB Axor gerade			AMP 1.5 180°	180	099 110 620



FRONTBELEUCHTUNG
FRONT LIGHTS



▪ **MB Actros II
Hauptscheinwerfer**

Hauptscheinwerfer mit Blinker und
Leuchtweitenregulierung

▪ **MB Actros II
head lamp**

Head lamp with indicator and levelling
device

OE- Nr. OE- No.	Leuchtmittel illuminant	Produktlinie product line	Anbauseite installation side	Art.-Nr. Part No.
943 820 0361	H1 H7	Eco^{Line}	◀ L	198 081 361
943 820 0461	H1 H7	Eco^{Line}	▶ R	198 081 461
943 820 0361	H1 H7	Premium^{Line}	◀ L	298 081 361
943 820 0461	H1 H7	Premium^{Line}	▶ R	298 081 461
943 820 0961	Xenon D2R		◀ L	098 081 334
943 820 1061	Xenon D2R		▶ R	098 081 335

Zusatzartikel

Produktart product type	Artikeltitel article title	Glasfarbe glass colour	Anbauseite installation side	Anschlussart connection type	Anbauwinkel mounting bracket	Art.-Nr. Part No.
Streuscheiben lens	Streuscheibe lens	weiß white	◀ L			198 109 832
Streuscheiben lens	Streuscheibe lens	weiß white	▶ R			198 109 833
Stecker connector	KIT NW 8,5 MB Actros, MB Axor gerade			AMP 1.5 180°	180	099 110 620



▪ **MB Actros III
 Hauptscheinwerfer**

Hauptscheinwerfer mit Blinker,
 Positionslicht und
 Leuchtweitenregulierung

▪ **MB Actros III
 head lamp**

Head lamp with indicator, position light
 and levelling device

OE- Nr. OE- No.	Leuchtmittel illuminant	Produktlinie product line	Anbauseite installation side	Art.-Nr. Part No.
943 820 1661	H1 H7	Premium	◀ L	298 081 336
943 820 1761	H1 H7	Premium	▶ R	298 081 337
943 820 2261	H1 Xenon D1S		◀ L	198 081 332
943 820 2361	Xenon D1S H1		▶ R	198 081 333

Zusatzartikel

Produktart product type	Artikeltitel article title	Glasfarbe glass colour	OE- Nr. OE- No.	Anbauseite installation side	Art.-Nr. Part No.
Montageteile mounting hardware	Scheinwerferrahmen (Chrom) headlight frame (chrome)		943 826 0359	▶ R	098 081 339
Montageteile mounting hardware	Scheinwerferrahmen (Chrom) headlight frame (chrome)		943 826 0259	◀ L	098 081 338
Montageteile mounting hardware	Scheinwerferrahmen (Chrom) headlight frame (chrome)		943 826 0259	◀ L	198 081 338
Montageteile mounting hardware	Scheinwerferrahmen (Chrom) headlight frame (chrome)		943 826 0359	▶ R	198 081 339
Streuscheiben lens	Streuscheibe lens	weiß white	000 826 4710	◀ L	198 109 838
Streuscheiben lens	Streuscheibe lens	weiß white	000 826 4610	▶ R	198 109 839



▪ **MB Actros III
Hauptscheinwerfer**

Hauptscheinwerfer mit Blinker und
Positionslicht

▪ **MB Actros III
head lamp**

Head lamp with indicator lamp and
position light

OE- Nr. OE- No.	Leuchtmittel illuminant	Produktlinie product line	Anbauseite installation side	Art.-Nr. Part No.
943 820 1461	H1 H7	Premium^{Line}	◀ L	298 081 330
943 820 1561	H1 H7	Premium^{Line}	▶ R	298 081 331
943 820 1461	H1 H7	Eco^{Line}	◀ L	198 081 330
943 820 1561	H1 H7	Eco^{Line}	▶ R	198 081 331

Zusatzartikel

Produktart product type	Artikeltitel article title	Glasfarbe glass colour	OE- Nr. OE- No.	Anbauseite installation side	Art.-Nr. Part No.
Montageteile mounting hardware	Scheinwerferrahmen (Chrom) headlight frame (chrome)		943 826 0359	▶ R	098 081 339
Montageteile mounting hardware	Scheinwerferrahmen (Chrom) headlight frame (chrome)		943 826 0259	◀ L	098 081 338
Montageteile mounting hardware	Scheinwerferrahmen (Chrom) headlight frame (chrome)		943 826 0259	◀ L	198 081 338
Montageteile mounting hardware	Scheinwerferrahmen (Chrom) headlight frame (chrome)		943 826 0359	▶ R	198 081 339
Streuscheiben lens	Streuscheibe lens	weiß white	000 826 4710	◀ L	198 109 838
Streuscheiben lens	Streuscheibe lens	weiß white	000 826 4610	▶ R	198 109 839



▪ **MB Actros IV
 Hauptscheinwerfer**

Hauptscheinwerfer mit Blinker

▪ **MB Actros IV
 head lamp**

Head lamp with indicator

OE- Nr. OE- No.	Leuchtmittel illuminant	Produktlinie product line	Anbauseite installation side	Art.-Nr. Part No.
A960 820 0239	H7	Premium	◀ L	298 081 510
A960 820 0339	H7	Premium	▶ R	298 081 500
A960 820 0639	Xenon D1S	Premium	◀ L	298 081 540
A960 820 0739	Xenon D1S	Premium	▶ R	298 081 530



▪ **MB Atego I
 Hauptscheinwerfer**

Hauptscheinwerfer mit
 Positionsbeleuchtung

▪ **MB Atego I
 head lamp**

Head lamp with position lamp

OE- Nr. OE- No.	Leuchtmittel illuminant	Anbauseite installation side	Art.-Nr. Part No.
973 820 0961	H4	◀ L	098 076 113
973 820 1061	H4	▶ R	098 076 114

Zusatzartikel

Produktart product type	Artikeltitel article title	Glasfarbe glass colour	OE- Nr. OE- No.	Anbauseite installation side	Anschlussart connection type	Anbauwinkel mounting bracket	Art.-Nr. Part No.
	Streuscheibe lens		004 826 1390 004 896 1390	◀ L			098 109 836
	Streuscheibe lens		004 896 1290 004 826 1290	▶ R			098 109 837
Stecker connector	KIT NW 8,5 MB Actros, MB Axor gerade				AMP 1.5 180°	180	099 110 620
Streuscheiben lens	Streuscheibe lens	weiß white	004 826 1390 004 896 1390	◀ L			198 109 836
Streuscheiben lens	Streuscheibe lens	weiß white	004 896 1290 004 826 1290	▶ R			198 109 837



FRONTBELEUCHTUNG
FRONT LIGHTS



▪ **MB Atego I
Hauptscheinwerfer**

Hauptscheinwerfer mit
Positionsbeleuchtung und
Leuchtweitenregulierung

▪ **MB Atego I
head lamp**

*Head lamp with position lamp and
levelling device*

OE- Nr. OE- No.	Leuchtmittel illuminant	Anbauseite installation side	Art.-Nr. Part No.
973 820 0161	H4	◀ L	198 076 313
973 820 0261	H4	▶ R	198 076 314

Zusatzartikel

Produktart product type	Artikeltitel article title	OE- Nr. OE- No.	Anbauseite installation side	Anschlussart connection type	Anbauwinkel mounting bracket	Art.-Nr. Part No.
	Streuscheibe lens	004 826 1390 004 896 1390	◀ L			098 109 836
	Streuscheibe lens	004 896 1290 004 826 1290	▶ R			098 109 837
Stecker connector	KIT NW 8,5 MB Actros, MB Axor gerade			AMP 1.5 180°	180	099 110 620



▪ **MB Atego I
Hauptscheinwerfer**

Hauptscheinwerfer mit
Positionsbeleuchtung,
Nebelscheinwerfer und
Leuchtweitenregulierung

▪ **MB Atego I
head lamp**

*Head lamp with position lamp,
fog lamp and levelling device*

OE- Nr. OE- No.	Leuchtmittel illuminant	Anbauseite installation side	Art.-Nr. Part No.
973 820 0561	H1 H4	◀ L	198 076 323
973 820 0661	H1 H4	▶ R	198 076 324

Zusatzartikel

Produktart product type	Artikeltitel article title	OE- Nr. OE- No.	Anbauseite installation side	Anschlussart connection type	Anbauwinkel mounting bracket	Art.-Nr. Part No.
	Streuscheibe lens	004 826 1390 004 896 1390	◀ L			098 109 836
	Streuscheibe lens	004 896 1290 004 826 1290	▶ R			098 109 837
Stecker connector	KIT NW 8,5 MB Actros, MB Axor gerade			AMP 1.5 180°	180	099 110 620



▪ **MB Atego II
 Hauptscheinwerfer**

Hauptscheinwerfer mit Positionsleuchte

▪ **MB Atego II
 head lamp**

Head lamp with position lamp

OE- Nr. OE- No.	Leuchtmittel illuminant	Anbauseite installation side	Art.-Nr. Part No.
973 820 22 61	H1 H7	◀ L	098 076 200
973 820 23 61	H1 H7	▶ R	098 076 201

Zusatzartikel

Produktart product type	Artikeltitel article title	OE- Nr. OE- No.	Anbauseite installation side	Anschlussart connection type	Anbauwinkel mounting bracket	Art.-Nr. Part No.
Streuscheiben lens	Streuscheibe lens	000 826 4410	◀ L			098 109 840
Streuscheiben lens	Streuscheibe lens	000 826 4510	▶ R			098 109 841
Stecker connector	KIT NW 8,5 MB Actros, MB Axor gerade			AMP 1.5 180°	180	099 110 620

**BESUCHEN SIE
 UNSERE HOMEPAGE
 WWW.RAL.AT**





▪ **MB Atego II
Hauptscheinwerfer**

Hauptscheinwerfer mit Positionsleuchte
und Leuchtweitenregulierung

▪ **MB Atego II
head lamp**

Head lamp with position lamp and
levelling device

OE- Nr. OE- No.	Leuchtmittel illuminant	Anbauseite installation side	Art.-Nr. Part No.
973 820 25 61	H1 H7	▶ R	098 076 211
973 820 24 61	H1 H7	◀ L	098 076 210

Zusatzartikel

Produktart product type	Artikeltitel article title	OE- Nr. OE- No.	Anbauseite installation side	Anschlussart connection type	Anbauwinkel mounting bracket	Art.-Nr. Part No.
Stecker connector	KIT NW 8,5 MB Actros, MB Axor gerade			AMP 1.5 180°	180	099 110 620
Streuscheiben lens	Streuscheibe lens	000 826 4410	◀ L			098 109 840
Streuscheiben lens	Streuscheibe lens	000 826 4510	▶ R			098 109 841



▪ **MB Atego II
 Hauptscheinwerfer**

Hauptscheinwerfer mit Positionsleuchte
 und Nebelscheinwerfer

▪ **MB Atego II
 head lamp**

Head lamp with position lamp and fog
 lamp

OE- Nr. OE- No.	Leuchtmittel illuminant	Anbauseite installation side	Art.-Nr. Part No.
973 820 26 61	H1 H7	◀ L	098 076 220
973 820 27 61	H7	▶ R	098 076 221

Zusatzartikel

Produktart product type	Artikeltitel article title	OE- Nr. OE- No.	Anbauseite installation side	Anschlussart connection type	Anbauwinkel mounting bracket	Art.-Nr. Part No.
Streuscheiben lens	Streuscheibe lens	000 826 4410	◀ L			098 109 840
Streuscheiben lens	Streuscheibe lens	000 826 4510	▶ R			098 109 841
Stecker connector	KIT NW 8,5 MB Actros, MB Axor gerade			AMP 1.5 180°	180	099 110 620



FRONTBELEUCHTUNG
FRONT LIGHTS



▪ **MB Atego II
Hauptscheinwerfer**

Hauptscheinwerfer mit Positionsleuchte,
Nebelscheinwerfer und
Leuchtweitenregulierung

▪ **MB Atego II
head lamp**

*Head lamp with position lamp, fog lamp
and levelling device*

OE- Nr. OE- No.	Leuchtmittel illuminant	Anbauseite installation side	Art.-Nr. Part No.
973 820 28 61	H1 H7	◀ L	098 076 230
973 820 29 61	H1 H7	▶ R	098 076 231

Zusatzartikel

Produktart product type	Artikeltitel article title	OE- Nr. OE- No.	Anbauseite installation side	Anschlussart connection type	Anbauwinkel mounting bracket	Art.-Nr. Part No.
Streuscheiben lens	Streuscheibe lens	000 826 4410	◀ L			098 109 840
Streuscheiben lens	Streuscheibe lens	000 826 4510	▶ R			098 109 841
Stecker connector	KIT NW 8,5 MB Actros, MB Axor gerade			AMP 1.5 180°	180	099 110 620



▪ **MB Axor II
Hauptscheinwerfer**

Hauptscheinwerfer mit Positionslicht

▪ **MB Axor II
head lamp**

Head lamp with position light

OE- Nr. OE- No.	Leuchtmittel illuminant	Anbauseite installation side	Art.-Nr. Part No.
940 820 0161	H1 H7	◀ L	098 150 021
940 820 0261	H1 H7	▶ R	098 150 022

Zusatzartikel

Produktart product type	Artikeltitel article title	Anschlussart connection type	Anbauwinkel mounting bracket	Art.-Nr. Part No.
Stecker connector	KIT MB Actros, Atego			099 111 116
Stecker connector	KIT NW 8,5 MB Actros, MB Axor gerade	AMP 1.5 180°	180	099 110 620



▪ Lindner Traktor
Hauptscheinwerfer

▪ Lindner Traktor
head lamp

Zusätzl. Leuchtenfunktionen <i>add. lighting functions</i>	Befestigungsart <i>mounting</i>	Anbauwinkel <i>mounting bracket</i>	Sockelausführung <i>socket version</i>	Anschlussspannung <i>connection voltage</i>	Anschlussart <i>connection type</i>	Leuchtmittel <i>illuminant</i>	Art.-Nr. <i>Part No.</i>
Positionslicht <i>position light</i>	Federbefestigung <i>fitted with springs</i>		P43t BA9s	12/24 V	Steckerposition oben <i>connector location top</i>	H4	098 109 000
	Federbefestigung <i>fitted with springs</i>		P43t BA9s	12/24 V	Steckerposition oben <i>connector location top</i>	H4	098 109 001
Positionslicht <i>position light</i>	Schraubenbefestigung <i>fitted with screw</i>		P43t BA9s	12/24 V	Steckerposition oben <i>connector location top</i>	H4	098 109 010
	Federbefestigung <i>fitted with springs</i>	8 °	P43t BA9s	12/24 V	Steckerposition unten <i>connector location below</i>	H4	098 109 020
	Federbefestigung <i>fitted with springs</i>	9 °	P43t BA9s	12/24 V	Steckerposition oben <i>connector location top</i>	H4	098 109 021

Zusatzartikel

Produktart <i>product type</i>	Artikeltitel <i>article title</i>	Glasfarbe <i>glass colour</i>	Art.-Nr. <i>Part No.</i>
Streuscheiben <i>lens</i>	Streuscheibe <i>lens</i>	weiß <i>white</i>	098 290 000
Montageteile <i>mounting hardware</i>	Dichtung <i>sealing</i>		098 290 001
Montageteile <i>mounting hardware</i>	Schutzgitter <i>protection grille</i>		098 290 002



FRONTBELEUCHTUNG
FRONT LIGHTS



▪ Case, IH, David Brown, Ford, Leyland, MF
Hauptscheinwerfer

▪ Case, IH, David Brown, Ford, Leyland, MF
head lamp

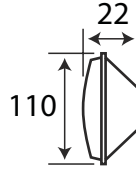

Anschlussleistung connected load	Anschlussspannung connection voltage	Leuchtmittel illuminant	Art.-Nr. Part No.
40 W	12 V	SB	098 105 444



▪ John Deere, Ursus
Hauptscheinwerfer

▪ John Deere, Ursus
head lamp

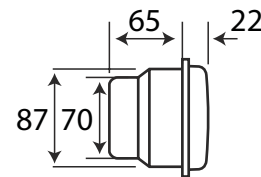
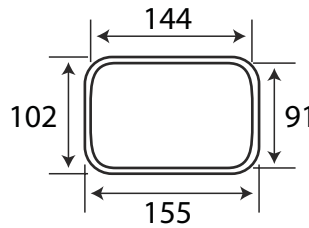

Sockelausführung socket version	Anschlussspannung connection voltage	Leuchtmittel illuminant	Art.-Nr. Part No.
P45t	12/24 V	R2	098 109 030



▪ **Universal
 Hauptscheinwerfer**

Hauptscheinwerfer mit Positionsleuchte.
 Kunststoffgehäuse

▪ **universal
 head lamp**

Head lamp with position lamp.
 plastic housing

Sockelausführung socket version	Anschlussspannung connection voltage	OE- Nr. OE- Nr.	Leuchtmittel illuminant	Art.-Nr. Part No.
P45t BA9s	12/24 V		H4 R2	098 120 144
P43t BA9s	12/24 V	1A3 996 002-161	H4 R2	098 120 146

Zusatzartikel

Produktart product type	Artikeltitel article title	OE- Nr. OE- No.	Art.-Nr. Part No.
	Reflektor reflector		098 105 124
Fassungen bulb holder	Stecksocket H4 mit 3 Flachsteckhülsen socket H4 with 3 blades receptacle	1 304 485 401	099 855 280



FRONTBELEUCHTUNG
FRONT LIGHTS



▪ **Universal
Hauptscheinwerfer**

Hauptscheinwerfer mit Positionsleuchte,
Gehäuse und Glasrahmen aus
Stahlblech, schwarz lackiert

▪ **universal
head lamp**

*Head lamp with position lamp, steel
housing and rim, black mat coated*

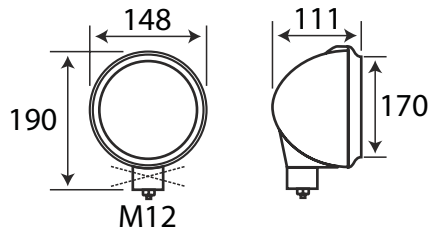

Sockelausführung socket version	Anschlussspannung connection voltage	Leuchtmittel illuminant	Art.-Nr. Part No.
P43t P45t BA9s BA9s	12/24 V	R2 H4	098 121 130



▪ **Universal
Hauptscheinwerfer**

mit Positionsleuchte, Gehäuse und
Glasrahmen, aus Stahlblech.
Schwarz, matt lackiert

▪ **universal
head lamp**

*Head lamp with position lamp, steel
sheet housing and rim.
Black mat coated*

Sockelausführung socket version	Anschlussspannung connection voltage	Art.-Nr. Part No.
BA20d	12/24 V	910 122 110



▪ **Universal
Hauptscheinwerfer**

mit Positionsleuchte, Gehäuse und
Glasrahmen aus Stahlblech.
Schwarz matt lackiert

▪ **universal
head lamp**

*Head lamp with position lamp, steel
sheet housing and rim
Black mat coated*

Sockelausführung socket version	Anschlussspannung connection voltage	Leuchtmittel illuminant	Art.-Nr. Part No.
P45t	12/24 V	R2	910 122 130



▪ **Universal
Hauptscheinwerfer**

mit Positionsleuchte

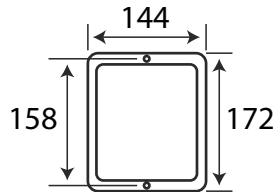

▪ *universal
head lamp*

with position lamp



Sockelausführung socket version	Anschlussspannung connection voltage	OE- Nr. OE- No.	Leuchtmittel illuminant	Art.-Nr. Part No.
P43t BA9s	12/24 V	1AA 127 473-015 1AA 004 109-041	H4	098 104 170



▪ **Universal
Hauptscheinwerfer**

mit Positionsleuchte

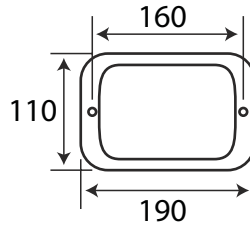

▪ *universal
head lamp*

with position lamp



Sockelausführung socket version	Anschlussspannung connection voltage	Leuchtmittel illuminant	Art.-Nr. Part No.
P43t BA9s	12/24 V	H4	098 105 190



■ Universal Hauptscheinwerfer

mit Positionsleuchte,
Befestigungsschraube M10

■ *universal* *head lamp*

with position lamp.
Fastening screw M10

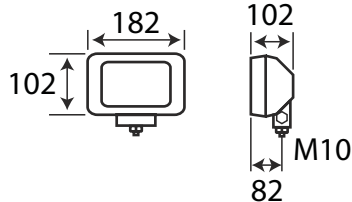

Sockelausführung socket version	Anschlussspannung connection voltage	Leuchtmittel illuminant	Art.-Nr. Part No.
P43t BA9s	12/24 V	H4	098 120 186



■ Universal Hauptscheinwerfer

mit Positionsleuchte
Befestigungsschraube M10

■ *universal* *head lamp*

with position lamp.
Fastening screw M10

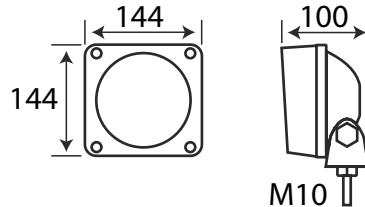

Sockelausführung socket version	Anschlussspannung connection voltage	Leuchtmittel illuminant	Art.-Nr. Part No.
P43t BA9s	12/24 V	H4	098 120 150

Zusatzartikel

Produktart product type	Artikeltitel article title	Art.-Nr. Part No.
Reflektoren reflector	Reflektor reflector	098 105 115



▪ **Universal
Hauptscheinwerfer**

mit Blinker und Positionsleuchte

▪ **universal
head lamp**

with indicator and position lamp

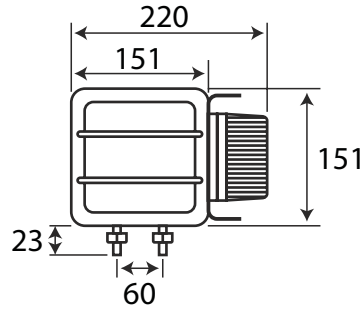

Sockelausführung socket version	Anschlussspannung connection voltage	Leuchtmittel illuminant	Anbauseite installation side	Art.-Nr. Part No.
P45t BA9s BA15s	12/24 V	H4	◀ L	098 105 472
P45t BA9s BA15s	12/24 V	H4	▶ R	098 105 473

Zusatzartikel

Produktart product type	Artikeltitel article title	Glasfarbe glass colour	Art.-Nr. Part No.
Montageteile mounting hardware	Schutzgitter protection grille		098 290 002
Streuscheiben lens	Streuscheibe lens	weiß white	098 290 000
Montageteile mounting hardware	Dichtung sealing		098 290 001



FRONTBELEUCHTUNG
FRONT LIGHTS



▪ **Universal
Hauptscheinwerfer**

mit Blinker und Positionsleuchte

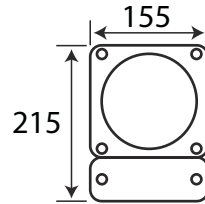

▪ **universal
head lamp**

with indicator and position lamp

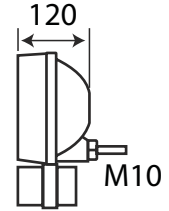

Sockelausführung socket version	Anschlussspannung connection voltage	OE- Nr. OE- No.	Leuchtmittel illuminant	Art.-Nr. Part No.
P43t BA9s BA15s	12/24 V	1EA 996 081-171	H4	098 128 150

Zusatzartikel

Artikeltitle article title	Glasfarbe glass colour	Art.-Nr. Part No.
Lichtscheibe Blinker lens	orange amber	098 297 300



▪ **Universal
Hauptscheinwerfer**

mit Blinker und Positionsleuchte

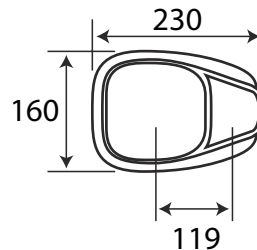

▪ **universal
head lamp**

with indicator and position lamp

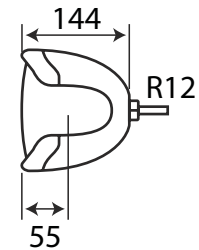

Sockelausführung socket version	Anschlussspannung connection voltage	Leuchtmittel illuminant	Anbauseite installation side	Art.-Nr. Part No.
P43t BAU15s W2,1x9,5d	12/24 V	H4	◀ L	098 128 505
P43t BAU15s W2,1x9,5d	12/24 V	H4	▶ R	098 128 515

ZUSATZSCHEINWERFER

ADDITIONAL LIGHTS





FRONTBELEUCHTUNG
FRONT LIGHTS



▪ DAF 95XF, Serie LF 01 >
Serie CF, XF95 03 >
Serie XF / XC105 06 >
Zusatzscheinwerfer

Nebel- und Fernscheinwerfer ohne
Rahmen

▪ *DAF 95XF, Serie LF 01 >
Serie CF, XF95 03 >
Serie XF / XC105 06 >
additional lights*

Fog lamp with high beam without frame

OE- Nr. OE- No.	Leuchtmittel <i>illuminant</i>	Anbauseite <i>installation side</i>	Art.-Nr. Part No.
1328860	H1 H3	◀ L	098 148 221
1328861	H1 H3	▶ R	098 148 222

Zusatzartikel

Produktart <i>product type</i>	Artikeltitel <i>article title</i>	Art.-Nr. Part No.
Stecker connector	KIT JPT 3PK1 DAF, Iveco	099 110 051



▪ DAF 95XF, Serie LF 01 >
Serie CF, XF95 03 >
Serie XF / XC105 06 >
Zusatzscheinwerfer

Nebel- und Fernscheinwerfer mit
Rahmen

▪ *DAF 95XF, Serie LF 01 >
Serie CF, XF95 03 >
Serie XF / XC105 06 >
additional lights*

Fog lamp with high beam with frame

OE- Nr. OE- No.	Leuchtmittel <i>illuminant</i>	Anbauseite <i>installation side</i>	Art.-Nr. Part No.
1328860	H1 H3	◀ L	098 148 223
1328861	H1 H3	▶ R	098 148 224

Zusatzartikel

Produktart <i>product type</i>	Artikeltitel <i>article title</i>	Art.-Nr. Part No.
Stecker connector	KIT JPT 3PK1 DAF, Iveco	099 110 051



▪ **DAF Serie LF 01 >, Serie CF / XF95 03 > Serie XF / XC105 06 > Zusatzscheinwerfer**

Nebel- und Fernscheinwerfer

▪ **DAF Serie LF 01 >, Serie CF / XF95 03 > Serie XF / XC105 06 > additional lights**

Fog lamp with high beam

OE- Nr. OE- No.	Leuchtmittel illuminant	Anbauseite installation side	Art.-Nr. Part No.
1725270	H3	◀ L	098 148 226
1725271	H3	▶ R	098 148 225

Zusatzartikel

Produktart product type	Artikeltitel article title	Art.-Nr. Part No.
Stecker connector	KIT JPT 3PK1 DAF, Iveco	099 110 051



▪ **Iveco Eurocargo 91 - 04, Eurotech, Eurostar Zusatzscheinwerfer**

Nebel- und Fernscheinwerfer

▪ **Iveco Eurocargo 91 - 04, Eurotech, Eurostar additional lights**

Fog lamp with high beam

OE- Nr. OE- No.	Leuchtmittel illuminant	Anbauseite installation side	Art.-Nr. Part No.
98437476	H1 H3	◀ L	098 055 003
98437475	H1 H3	▶ R	098 055 004

Zusatzartikel

Produktart product type	Artikeltitel article title	Art.-Nr. Part No.
Stecker connector	KIT SUPER SEAL NW 4,5	099 110 129



FRONTBELEUCHTUNG
FRONT LIGHTS



▪ **Iveco Eurocargo 04 > Zusatzscheinwerfer**

Fernscheinwerfer

▪ **Iveco Eurocargo 04 > additional lights**

High beam

OE- Nr. OE- No.	Leuchtmittel illuminant	Anbauseite installation side	Art.-Nr. Part No.
504052353	H1	◀ L	098 089 335
504052352	H1	▶ R	098 089 336

Zusatzartikel

Produktart product type	Artikeltitel article title	Art.-Nr. Part No.
Stecker connector	KIT SUPER SEAL NW 4,5	099 110 129



▪ **Iveco Stralis I 03 - 06 Zusatzscheinwerfer**

Nebelscheinwerfer

▪ **Iveco Stralis I 03 - 06 additional lights**

Fog lamp

Leuchtmittel illuminant	Art.-Nr. Part No.
H1	098 055 094

Zusatzartikel

Produktart product type	Artikeltitel article title	Art.-Nr. Part No.
Stecker connector	KIT SUPER SEAL NW 4,5	099 110 129



▪ **Iveco Stralis I 03 - 06
Zusatzscheinwerfer**

Fernscheinwerfer

▪ **Iveco Stralis I 03 - 06
additional lights**

High beam

FRONTBELEUCHTUNG
FRONT LIGHTS

Leuchtmittel <i>illuminant</i>	Art.-Nr. <i>Part No.</i>
H1	098 055 092

Zusatzartikel

Produktart <i>product type</i>	Artikeltitel <i>article title</i>	Art.-Nr. <i>Part No.</i>
Stecker connector	KIT SUPER SEAL NW 4,5	099 110 129

**ALLE ARTIKEL FINDEN
SIE AUCH IN UNSEREM
WEBSHOP**





FRONTBELEUCHTUNG
FRONT LIGHTS



- Iveco Stralis II ab 08 / Trakker II Zusatzscheinwerfer
- Iveco Stralis II ab 08 / Trakker II additional lights

Fernscheinwerfer

High beam

OE- Nr. OE- No.	Leuchtmittel illuminant	Produktlinie product line	Art.-Nr. Part No.
504181096	H1	Premium ^{Line}	098 055 096
504181096	H1	Eco ^{Line}	198 055 096

Zusatzartikel

Produktart product type	Artikeltitel article title	OE- Nr. OE- No.	Anbauseite installation side	Art.-Nr. Part No.
Stecker connector	KIT SUPER SEAL NW 4,5			099 110 129
	Einbaurahmen frame	504188130	◀ L	198 055 102
	Einbaurahmen frame	504188129	▶ R	198 055 103



- **Iveco Stralis II ab 08 / Trakker II Zusatzscheinwerfer**
- **Iveco Stralis II starting 08 / Trakker II additional lights**

Nebelscheinwerfer

Fog lamp

OE- Nr. OE- No.	Leuchtmittel illuminant	Produktlinie product line	Art.-Nr. Part No.
504181095	H1	Premium ^{Line}	098 055 098
504181095	H1	Eco ^{Line}	198 055 098

Zusatzartikel

Produktart product type	Artikeltitel article title	OE- Nr. OE- No.	Anbauseite installation side	Art.-Nr. Part No.
Stecker connector	KIT SUPER SEAL NW 4,5			099 110 129
	Einbaurahmen frame	504188130	◀ L	198 055 102
	Einbaurahmen frame	504188129	▶ R	198 055 103



- **Renault Trucks Premium 96 - 05 Zusatzscheinwerfer**
- **Renault Trucks Premium 96 - 05 additional lights**

Fernscheinwerfer mit Nebelscheinwerfer

High beam with fog lamp

OE- Nr. OE- No.	Leuchtmittel illuminant	Anbauseite installation side	Art.-Nr. Part No.
5010231849	H1 H1	◀ L	098 148 184
5010231850	H1 H1	▶ R	098 148 185

Zusatzartikel

Produktart product type	Artikeltitel article title	Art.-Nr. Part No.
Stecker connector	KIT JPT 2PK1	099 110 006



FRONTBELEUCHTUNG
FRONT LIGHTS



▪ **Renault Trucks Magnum E-Tech 01 > Zusatzscheinwerfer**

Nebelscheinwerfer

▪ **Renault Trucks Magnum E-Tech 01 > additional lights**

Fog lamp

OE- Nr. OE- No.	Leuchtmittel illuminant	Art.-Nr. Part No.
5010312972	H1	098 089 190

Zusatzartikel

Produktart product type	Artikeltitel article title	Art.-Nr. Part No.
Stecker connector	KIT JPT 2PK1	099 110 006



▪ **MAN F2000 Zusatzscheinwerfer**

Nebelscheinwerfer Baustellen-Version

▪ **MAN F2000 additional lights**

Fog lamp version for construction site

OE- Nr. OE- No.	Leuchtmittel illuminant	Art.-Nr. Part No.
81.25102-6085	H3	098 151 001







▪ **MAN F2000, M2000M
Zusatzscheinwerfer**

Nebel- und Fernscheinwerfer

▪ **MAN F2000, M2000M
additional lights**

Fog lamp with high beam

OE- Nr. OE- No.	Leuchtmittel illuminant	Produktlinie product line	Anbauseite installation side	Art.-Nr. Part No.
81.25101-6339	H3		◀ L	198 148 339
81.25101-6338	H3		▶ R	198 148 338
81.25101-6339	H3		◀ L	398 148 339
81.25101-6338	H3		▶ R	398 148 338







▪ **MAN TGA, TGL, TGM, LE2000,
Bus 98 >
Zusatzscheinwerfer**

Fernscheinwerfer mit Nebelscheinwerfer
und Blinker

▪ **MAN TGA, TGL, TGM, LE2000,
Bus 98 >
additional lights**

High beam with fog lamp and indicator

OE- Nr. OE- No.	Leuchtmittel illuminant	Produktlinie product line	Anbauseite installation side	Art.-Nr. Part No.
81.25320-6091 81.25320-6111	H4		◀ L	198 222 791
81.25320-6092 81.25320-6112	H4		▶ R	198 222 792
81.25320-6091 81.25320-6111	H4		◀ L	298 222 791
81.25320-6092 81.25320-6112	H4		▶ R	298 222 792

Zusatzartikel

Produktart product type	Artikeltitel article title	Art.-Nr. Part No.
Stecker connector	KIT Stecker KIT plug	099 111 672



▪ MAN TGA, TGL, TGM, LE2000,
Bus 98 >
Zusatzscheinwerfer

Fernscheinwerfer mit Nebelscheinwerfer
und weißem Blinker

▪ MAN TGA, TGL, TGM, LE2000,
Bus 98 >
additional lights

High beam with fog lamp and white
indicator

OE- Nr. OE- No.	Leuchtmittel illuminant	Produktlinie product line	Anbauseite installation side	Art.-Nr. Part No.
81.25320-6113	H4	Premium	◀ L	298 222 793
81.25320-6112	H4	Premium	▶ R	298 222 794

Zusatzartikel

Produktart product type	Artikeltitel article title	Art.-Nr. Part No.
Stecker connector	KIT Stecker KIT plug	099 111 672



▪ MAN TGA, TGL, TGM, LE2000,
Bus 98 >
Zusatzscheinwerfer

mit Blinker

▪ MAN TGA, TGL, TGM, LE2000,
Bus 98 >
additional lights

with Indicator

OE- Nr. OE- No.	Anbauseite installation side	Art.-Nr. Part No.
81.25320-6089	◀ L	198 222 789
81.25320-6090	▶ R	198 222 790

Zusatzartikel

Produktart product type	Artikeltitel article title	Art.-Nr. Part No.
Stecker connector	KIT Stecker KIT plug	099 111 672



▪ **MAN TGX 08 >
 Zusatzscheinwerfer**

Fernscheinwerfer mit Nebelscheinwerfer
 und Abbiegelicht

▪ **MAN TGX 08 >
 additional lights**

*High beam with fog lamp and curve
 lamp*

OE- Nr. OE- No.	Leuchtmittel illuminant	Produktlinie product line	Anbauseite installation side	Art.-Nr. Part No.
81.25101-6521	H3 H4	Premium	◀ L	298 143 050
81.25101-6522	H3 H4	Premium	▶ R	298 143 051

Zusatzartikel

Produktart product type	Artikeltitel article title	Glasfarbe glass colour	OE- Nr. OE- No.	Anbauseite installation side	Art.-Nr. Part No.
Stecker connector	KIT Stecker KIT plug				099 111 672
	Streuscheibe lens	weiß white	81.25110-0085	◀ L	198 109 885
	Streuscheibe lens	weiß white	81.25110-0086	▶ R	198 109 886



▪ **Scania 4 96 >
 Zusatzscheinwerfer**

Nebel- und Fernscheinwerfer

▪ **Scania 4 96 >
 additional lights**

Fog lamp and high beam

OE- Nr. OE- No.	Leuchtmittel illuminant	Anbauseite installation side	Art.-Nr. Part No.
1529070 1422991	H3	◀ L	098 148 991
1529071 1422992	H3	▶ R	098 148 992



FRONTBELEUCHTUNG
FRONT LIGHTS



Scania P / G / R / T 04 > Zusatzscheinwerfer

Nebelscheinwerfer

Scania P / G / R / T 04 > additional lights

Fog lamp

OE- Nr. OE- No.	Leuchtmittel illuminant	Anbauseite installation side	Art.-Nr. Part No.
1852572 1446355	H1	◀ L	098 055 204
1852573 1446356	H1	▶ R	098 055 205

Zusatzartikel

Produktart product type	Artikeltitel article title	Art.-Nr. Part No.
Stecker connector	KIT JPT 2PK1	099 110 006



▪ Scania P / G / R / T 04 >
Zusatzscheinwerfer

Fernscheinwerfer

▪ Scania P / G / R / T 04 >
additional lights

High beam

OE- Nr. OE- No.	Leuchtmittel illuminant	Anbauseite installation side	Art.-Nr. Part No.
1852569 1446353	H1	◀ L	098 055 202
1852570 1446354	H1	▶ R	098 055 203

Zusatzartikel

Produktart product type	Artikeltitel article title	Art.-Nr. Part No.
Stecker connector	KIT JPT 2PK1	099 110 006



▪ Volvo FH, FM 93 - 01
Zusatzscheinwerfer

Nebelscheinwerfer mit Positionsleuchte

▪ Volvo FH, FM 93 - 01
additional lights

Fog lamp with position lamp

OE- Nr. OE- No.	Leuchtmittel illuminant	Anbauseite installation side	Art.-Nr. Part No.
3980334 20360273	H3	◀ L	098 153 334
3980335 20360274	H3	▶ R	098 153 335

Zusatzartikel

Produktart product type	Artikeltitel article title	OE- Nr. OE- No.	Art.-Nr. Part No.
Fassungen bulb holder	Lampenfassung mit 2- poligem Stecker bulb holder with 2 pole connector	3090947	098 299 972



FRONTBELEUCHTUNG
FRONT LIGHTS



▪ **Volvo FM / FH III 08 > Zusatzscheinwerfer**

Nebelscheinwerfer Ausführung Chrom, Einachscheinwerfer mit einem Projektionsscheinwerfer

▪ **Volvo FM / FH III 08 > additional lights**

Fog lamp, chrome finish, single lamp with one projection lamp

OE- Nr. OE- No.	Leuchtmittel illuminant	Anbauseite installation side	Art.-Nr. Part No.
21297911 21297914	H3	◀ L	098 153 001
21297913 21297909	H3	▶ R	098 153 002



▪ **Volvo FH, FM 93 - 01 Zusatzscheinwerfer**

Nebelscheinwerfer mit Positionsleuchte Einbau mit "CLIP"

▪ **Volvo FH, FM 93 - 01 additional lights**

Fog lamp with position lamp installation with "CLIP"

OE- Nr. OE- No.	Leuchtmittel illuminant	Anbauseite installation side	Art.-Nr. Part No.
3980334	H3	◀ L	098 153 336
3980335	H3	▶ R	098 153 337

Zusatzartikel

Produktart product type	Artikeltitel article title	OE- Nr. OE- No.	Art.-Nr. Part No.
Fassungen bulb holder	Lampenfassung mit 2-poligem Stecker bulb holder with 2 pole connector	3090947	098 299 972



▪ **Volvo FM / FH III 08 > Zusatzscheinwerfer**

Nebelscheinwerfer, Ausführung Chrom, mit schwarzem Rahmen, Doppelscheinwerfer mit einem Projektions- und einem Reflektorscheinwerfer

▪ **Volvo FM / FH III 08 > additional lights**

Fog lamp, chrome finish with black frame, double lamp with one projection- and one reflectorlamp

Leuchtmittel illuminant	Produktlinie product line	Anbauseite installation side	Art.-Nr. Part No.
H3 H3	Premium	◀ L	298 153 005
H3 H3	Premium	▶ R	298 153 006



▪ **Volvo FH III 16 08 > Zusatzscheinwerfer**

Nebelscheinwerfer, Ausführung schwarz, Doppelscheinwerfer mit einem Projektionscheinwerfer und einem Kurvenlicht

▪ **Volvo FH III 16 08 > additional lights**

Fog lamp, black finish, double lamp with one projection- and one curve light

OE- Nr. OE- No.	Leuchtmittel illuminant	Produktlinie product line	Anbauseite installation side	Art.-Nr. Part No.
21035701	H3 H7	Premium	◀ L	298 153 007
21035700	H3 H7	Premium	▶ R	298 153 008



▪ **Volvo FM / FH III 08 > Zusatzscheinwerfer**

Nebelscheinwerfer, Ausführung Chrom, Doppelscheinwerfer mit einem Projektions- und einem Reflektorscheinwerfer

▪ **Volvo FM / FH III 08 > additional lights**

Fog lamp, chrome finish, double lamp with one projection- and one reflectorlamp

OE- Nr. OE- No.	Leuchtmittel illuminant	Produktlinie product line	Anbauseite installation side	Art.-Nr. Part No.
21297918	H3 H3	Premium	◀ L	298 153 003
21297917	H3 H3	Premium	▶ R	298 153 004



FRONTBELEUCHTUNG
FRONT LIGHTS



▪ **MB Actros I, 96 - 02**
Zusatzscheinwerfer

Fernscheinwerfer

▪ **MB Actros I, 96 - 02**
additional lights

High beam

OE- Nr. OE- No.	Leuchtmittel illuminant	Produktlinie product line	Anbauseite installation side	Art.-Nr. Part No.
002 820 76 56 002 820 84 56	H3	Premium ^{Line}	◀ L	298 143 011
002 820 77 56 002 820 84 56	H3	Premium ^{Line}	▶ R	298 143 021

Zusatzartikel

Produktart product type	Artikeltitel article title	OE- Nr. OE- No.	Anbauseite installation side	Art.-Nr. Part No.
Montageteile mounting hardware	Montagerahmen holder	000 816 1759 000 826 1759	◀ L	098 143 910
Montageteile mounting hardware	Montagerahmen holder	000 816 1859 000 826 1859	▶ R	098 143 920
Stecker connector	KIT JPT 2PK1 NW 4,5			099 110 386

**INFORMIEREN SIE SICH
AUCH ÜBER UNSERE
WARN- UND ARBEITSLEUCHTEN**

WWW.RAL.AT





▪ **MB Actros I, 96 - 02**
Zusatzscheinwerfer

Nebelscheinwerfer
inkl. Rahmen

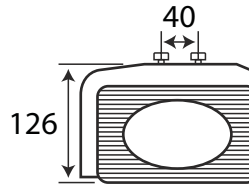

▪ **MB Actros I, 96 - 02**
additional lights

Fog lamp
With frame

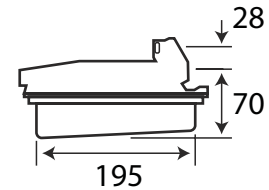

OE- Nr. OE- No.	Leuchtmittel illuminant	Anbauseite installation side	Art.-Nr. Part No.
002 820 78 56 002 820 86 56	H3	◀ L	098 153 016
002 820 79 56 002 820 87 56	H3	▶ R	098 153 026

Zusatzartikel

Produktart product type	Artikeltitel article title	OE- Nr. OE- No.	Anbauseite installation side	Art.-Nr. Part No.
Montageteile mounting hardware	Montagerahmen holder	000 816 1759 000 826 1759	◀ L	098 143 910
Montageteile mounting hardware	Montagerahmen holder	000 816 1859 000 826 1859	▶ R	098 143 920
Stecker connector	KIT JPT 2PK1 NW 4,5			099 110 386



▪ **MB Actros II, III**
Zusatzscheinwerfer

▪ **MB Actros II, III**
additional lights

OE- Nr. OE- No.	Leuchtmittel illuminant	Produktlinie product line	Anbauseite installation side	Art.-Nr. Part No.
943 820 00 56	H3	Line Eco	◀ L	198 153 056
943 820 01 56	H3	Line Eco	▶ R	198 153 156

Zusatzartikel

Produktart product type	Artikeltitel article title	Art.-Nr. Part No.
Stecker connector	KIT MB Actros, Atego	099 111 116



FRONTBELEUCHTUNG
FRONT LIGHTS



▪ **MB Actros II, III
Zusatzscheinwerfer**

Nebelscheinwerfer

▪ **MB Actros II, III
additional lights**

Fog lamp

OE- Nr. OE- No.	Leuchtmittel illuminant	Produktlinie product line	Anbauseite installation side	Art.-Nr. Part No.
943 820 00 56	H3	Premium ^{LED}	◀ L	298 153 056
943 820 01 56	H3	Premium ^{LED}	▶ R	298 153 156

Zusatzartikel

Produktart product type	Artikeltitel article title	Art.-Nr. Part No.
Stecker connector	KIT MB Actros, Atego	099 111 116



▪ **MB Axor II
Zusatzscheinwerfer**

Nebelscheinwerfer

▪ **MB Axor II
additional lights**

Fog lamp

OE- Nr. OE- No.	Leuchtmittel illuminant	Anbauseite installation side	Art.-Nr. Part No.
940 820 00 56	H1	◀ L	198 153 066
940 820 01 56	H1	▶ R	198 153 166

Zusatzartikel

Produktart product type	Artikeltitel article title	Art.-Nr. Part No.
Stecker connector	KIT MB Actros, Atego	099 111 116



▪ **MB Actros MP 4
 Zusatzscheinwerfer**

Nebelscheinwerfer

▪ **MB Actros MP 4
 additional lights**

Fog lamp

OE- Nr. OE- No.	Leuchtmittel illuminant	Produktlinie product line	Anbauseite installation side	Art.-Nr. Part No.
960 820 05 56	H3	Premium^{LED}	▶ R	298 153 170
960 820 04 56	H3	Premium^{LED}	◀ L	298 153 070



▪ **Universal
 Zusatzscheinwerfer**

Fernscheinwerfer Voll-LED CIBIE,
 Ausführung chrom

▪ **universal
 additional lights**

High beam full-LED "CIBIE", chrome

Anschlussspannung connection voltage	Anschlussart connection type	Leuchtmittel illuminant	Art.-Nr. Part No.
12/24 V	Stecker connector	LED	098 142 180



FRONTBELEUCHTUNG
FRONT LIGHTS



▪ **Universal Zusatzscheinwerfer**

▪ *universal additional lights*

Fernscheinwerfer

High beam

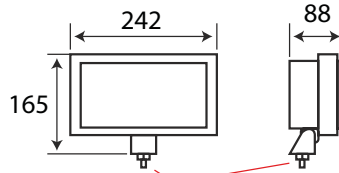

Befestigungsschraube M10
mounting screw M10

Anschlussspannung <i>connection voltage</i>	Glasfarbe <i>glass colour</i>	OE- Nr. <i>OE- No.</i>	Leuchtmittel <i>illuminant</i>	Art.-Nr. <i>Part No.</i>
12/24 V	klar clear	82.25101-6027 1FE 006 300-041 1FE 006 300-048	H3	098 142 110



▪ **Universal Zusatzscheinwerfer**

▪ *universal additional lights*

Nebelscheinwerfer

Fog lamp

Anschlussspannung <i>connection voltage</i>	Glasfarbe <i>glass colour</i>	OE- Nr. <i>OE- No.</i>	Leuchtmittel <i>illuminant</i>	Art.-Nr. <i>Part No.</i>
12/24 V	klar clear	82.25102-6088 1NE 006 300-058 1NE 006 300-051	H3	098 152 100



▪ **Universal Zusatzscheinwerfer**

▪ *universal additional lights*

Fernscheinwerfer

High beam

Sockelausführung <i>socket version</i>	Anschlussspannung <i>connection voltage</i>	OE- Nr. <i>OE- No.</i>	Leuchtmittel <i>illuminant</i>	Art.-Nr. <i>Part No.</i>
PK22s W2,1x9,5d	12/24 V	1F8 006 800-191 1F8 006 800-101	H3	098 142 150



▪ **Universal
Zusatzscheinwerfer**

Fernscheinwerfer mit Positionslicht

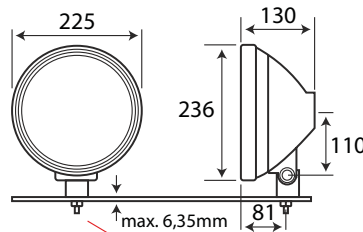

Befestigungsschraube M10
mounting screw M10

▪ *universal
additional lights*

High beam with position lamp

Anschlussspannung <i>connection voltage</i>	Glasfarbe <i>glass colour</i>	OE- Nr. <i>OE- No.</i>	Leuchtmittel <i>illuminant</i>	Art.-Nr. <i>Part No.</i>
12/24 V	blau blue	1F8 006 800-221	H3	098 142 155



▪ **Universal
Zusatzscheinwerfer**

Fernscheinwerfer mit Standlicht
Edelstahlgehäuse

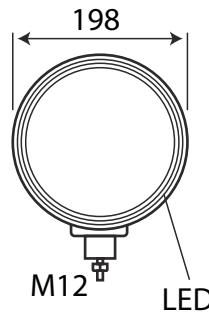

▪ *universal
additional lights*

*High beam with sidelight
Stainless steel housing*

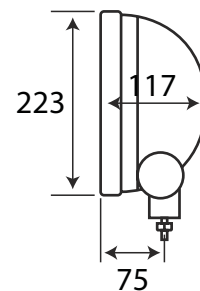

Glasfarbe <i>glass colour</i>	Leuchtmittel <i>illuminant</i>	Art.-Nr. <i>Part No.</i>
klar clear	H3 LED	098 142 140



FRONTBELEUCHTUNG
FRONT LIGHTS



▪ **Universal
Zusatzscheinwerfer**

Fernscheinwerfer, Edelstahlgehäuse

▪ *universal
additional lights*

High beam, stainless steel housing

Glasfarbe <i>glass colour</i>	Leuchtmittel <i>illuminant</i>	Art.-Nr. <i>Part No.</i>
blau blue	H3 LED	098 142 145

POSITIONSLEUCHTEN

POSITION LAMPS





▪ **DAF CF Serie, XF95 03 >, XF / XC105 06 >**
Positionsleuchte

▪ **DAF CF Serie, XF95 03 >, XF / XC105 06 >**
position lamp

Leuchtenfunktionen

Positionslicht

lighting functions

position light

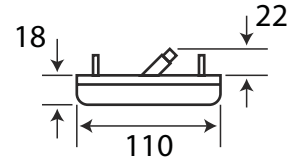
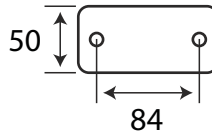

Anschlussspannung connection voltage	Anschlussart connection type	Glasfarbe glass colour	OE- Nr. OE- No.	Art.-Nr. Part No.
12/24 V	Flachstecker 6,3mm flat connector 6.3mm	weiß white	1653605	098 231 381

Zusatzartikel

Produktart product type	Artikeltitel article title	OE- Nr. OE- No.	Art.-Nr. Part No.
Fassungen bulb holder	Fassung bulb holder	160 33 52 500 184 7589	098 291 381
Stecker connector	KIT JPT 2PK1		099 110 006



▪ **Iveco Stralis I/II, Eurocargo 04 >**
Positionsleuchte

▪ **Iveco Stralis I/II, Eurocargo 04 >**
position lamp

Leuchtenfunktionen

Positionslicht

lighting functions

position light

Anschlussspannung connection voltage	Glasfarbe glass colour	OE- Nr. OE- No.	Kabellänge cable length	Anbauseite installation side	Art.-Nr. Part No.
24 V	weiß white	504 047 265	100 mm	R	098 230 050
24 V	weiß white	504 047 264	100 mm	L	098 230 040



▪ **Renault Trucks Magnum AE, Magnum E-Tech Positionslampe**

▪ *Renault Trucks Magnum AE, Magnum E-Tech position lamp*

Leuchtenfunktionen

Positionslicht

lighting functions

position light

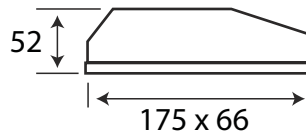

Glasfarbe glass colour	OE- Nr. OE- No.	Art.-Nr. Part No.
weiß white	501 021 7022	098 242 820



▪ **Renault Trucks Kerax, Premium, Midlum, DAF LF Serie Positionslampe**

▪ *Renault Trucks Kerax, Premium Midlum, DAF LF Serie position lamp*

Leuchtenfunktionen

Positionslicht

lighting functions

position light

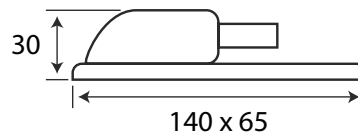

Glasfarbe glass colour	OE- Nr. OE- No.	Art.-Nr. Part No.
weiß white	500 183 5461	098 230 010



▪ **Scania P / G / R / T 04 > Positionslampe**

▪ *Scania P / G / R / T 04 > position lamp*

Positionslampe vorne, Einbau, mit 2-poligem Flachsteckanschluss

Position lamp front, with 2-pole plug connector

Leuchtenfunktionen

Positionslicht

lighting functions

position light

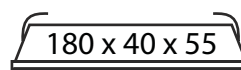

Anschlussspannung connection voltage	LED Anzahl LED number	Glasfarbe glass colour	OE- Nr. OE- No.	Leuchtmittel illuminant	Art.-Nr. Part No.
24 V	4	weiß white	1 910 437 1 798 980	LED	098 230 610



FRONTBELEUCHTUNG
FRONT LIGHTS



- **MAN F / M, M2000L / M2000M, F2000**
Positionslampe
- **MAN F / M, M2000L / M2000M, F2000**
position lamp

Leuchtenfunktionen	lighting functions
Positionslampe	position light

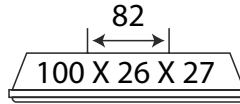

Anschlussspannung connection voltage	Anschlussart connection type	Glasfarbe glass colour	OE- Nr. OE- No.	Produktlinie product line	Art.-Nr. Part No.
24 V	Flachstecker 6,3mm flat connector 6.3mm	weiß white	81.25102.6039		098 200 800
24 V	Flachstecker 6,3mm flat connector 6.3mm	weiß white	81.25102.6039		398 200 800



- **MAN TGA / TGL / TGM / TGS / TGX**
Positionslampe
- **MAN TGA / TGL / TGM / TGS / TGX**
position lamp

Leuchtenfunktionen	lighting functions
Positionslampe	position light

Anschlussspannung connection voltage	LED Anzahl LED number	Glasfarbe glass colour	OE- Nr. OE- No.	Leuchtmittel illuminant	Produktlinie product line	Art.-Nr. Part No.
24 V	6	weiß white	81.25260-6121	LED		198 231 810
24 V	6	weiß white	81.25260-6121	LED		398 231 810



- **MB**
Positionslampe
- **MB**
position lamp

Positionslampe vorne mit Gummiauflage

With rubber base

Leuchtenfunktionen	lighting functions
Positionslampe	position light

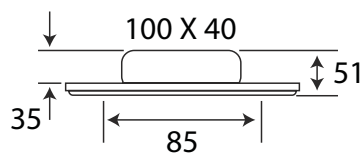

Anschlussspannung connection voltage	Anschlussart connection type	Glasfarbe glass colour	OE- Nr. OE- No.	Art.-Nr. Part No.
24 V	Flachstecker 6,3mm flat connector 6.3mm	weiß white	002 820 00 56 000 826 34 47	098 242 901



▪ **MB Atego I/II, Axor I/II**
Positionsleuchte

▪ **MB Atego I/II, Axor I/II**
position lamp

Leuchtenfunktionen

Positionslicht

lighting functions

position light

Glasfarbe glass colour	OE- Nr. OE- No.	Anbauseite installation side	Art.-Nr. Part No.
weiß white	002 820 51 56	R	098 230 030
weiß white	002 820 50 56	L	098 230 020



▪ **Volvo FH, FM 93-01**
Positionsleuchte

▪ **Volvo FH, FM 93-01**
position lamp

Leuchtenfunktionen

Positionslicht

lighting functions

position light

250 x 90 x 70

Glasfarbe glass colour	OE- Nr. OE- No.	Art.-Nr. Part No.
weiß white	8191142 3981666	098 233 051

Zusatzartikel

Produktart product type	Artikeltitel article title	OE- Nr. OE- No.	Art.-Nr. Part No.
Fassungen bulb holder	Lampenfassung mit 2-poligem Stecker bulb holder with 2 pole connector	3090947	098 299 972



▪ Volvo FM II / FH II 02 >
Positionsleuchte

▪ Volvo FM II / FH II 02 >
position lamp

Leuchtenfunktionen

Positionslicht

lighting functions

position light

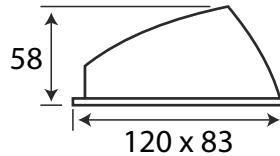

Glasfarbe glass colour	OE- Nr. OE- No.	Art.-Nr. Part No.
weiß white	1623726	098 233 053



▪ Universal Kugel
Positionsleuchte

▪ Universal Kugel
position lamp

Leuchtenfunktionen

Positionslicht
Rückstrahler

lighting functions

position light
reflector

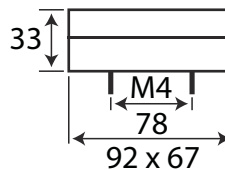

Sockelausführung socket version	Anschlussspannung connection voltage	Glasfarbe glass colour	OE- Nr. OE- No.	Art.-Nr. Part No.
SV8,5-36	12/24 V	weiß white	2PG 340 000-121	098 230 108



▪ Universal
Positionsleuchte

▪ Universal
position lamp

Leuchtenfunktionen

Positionslicht

lighting functions

position light

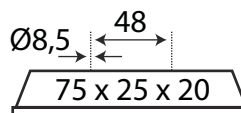

Anschlussleistung connected load	Anschlussspannung connection voltage	LED Anzahl LED number	Glasfarbe glass colour	Kabellänge cable length	Leuchtmittel illuminant	Art.-Nr. Part No.
0.4 W	12 V	1	weiß white	100 mm	LED	098 233 305
0.7 W	24 V	1	weiß white	100 mm	LED	098 233 306

Ⓔ



▪ **Universal
Positionsleuchte**

▪ **Universal
position lamp**

Leuchtenfunktionen

Positionslicht
Rückstrahler

lighting functions

position light
reflector

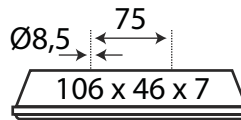

Anschlussleistung <i>connected load</i>	Anschlussspannung <i>connection voltage</i>	LED Anzahl <i>LED number</i>	Glasfarbe <i>glass colour</i>	Kabellänge <i>cable length</i>	Leuchtmittel <i>illuminant</i>	Art.-Nr. <i>Part No.</i>
0.7 W	12 V	1	weiß white	180 mm	LED	098 233 302
1.4 W	24 V	1	weiß white	180 mm	LED	098 233 304

Zusatzartikel

Produktart <i>product type</i>	Artikeltitel <i>article title</i>	Art.-Nr. <i>Part No.</i>
Dichtungen sealing	Dichtung sealing	098 291 356

Ⓔ



▪ **Universal
Positionsleuchte**

▪ **Universal
position lamp**

Leuchtenfunktionen

Positionslicht
Rückstrahler

lighting functions

position light
reflector

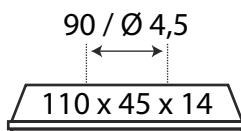

Anschlussspannung <i>connection voltage</i>	Anschlussart <i>connection type</i>	LED Anzahl <i>LED number</i>	Glasfarbe <i>glass colour</i>	Kabellänge <i>cable length</i>	Leuchtmittel <i>illuminant</i>	Art.-Nr. <i>Part No.</i>
12 V	Flachstecker 6,3mm flat connector 6.3mm	3	weiß white	100 mm	LED	j11.1010.100
24 V	Flachstecker 6,3mm flat connector 6.3mm	3	weiß white	165 mm	LED	j11.1011.150
12 V	Click-In	3	weiß white	500 mm	LED	j11.1010.805

Zusatzartikel

Produktart <i>product type</i>	Artikeltitel <i>article title</i>	Art.-Nr. <i>Part No.</i>
Montageteile mounting hardware	Anbauwinkel mounting bracket	j19.2014.501



Ⓔ



▪ **Universal Positionslampe**

▪ **Universal position lamp**

Für horizontale und vertikale Montage geeignet, variabler Montageabstand 65-90mm

for horizontal and vertical installation, variable hole distance 65-90mm

Leuchtenfunktionen	lighting functions
Positionslicht Rückstrahler	position light reflector

Anschlussspannung connection voltage	LED Anzahl LED number	Glasfarbe glass colour	Kabellänge cable length	Leuchtmittel illuminant	Art.-Nr. Part No.
9 - 33 V	4	weiß white	5000 mm	LED	098 230 605
9 - 33 V	4	weiß white	500 mm	LED	098 230 601

Ⓔ



▪ **Universal Positionslampe**

▪ **Universal position lamp**

Für horizontale und vertikale Montage, variabler Montageabstand 30 oder 50mm

for horizontal and vertical installation, variable hole distance 30 or 50mm

Leuchtenfunktionen	lighting functions
Positionslicht Rückstrahler	position light reflector

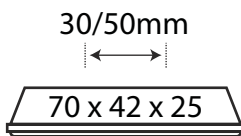

Anschlussspannung connection voltage	LED Anzahl LED number	Glasfarbe glass colour	Kabellänge cable length	Leuchtmittel illuminant	Art.-Nr. Part No.
9 - 33 V	4	weiß white	500 mm	LED	098 230 501
9 - 33 V	4	weiß white	5000 mm	LED	098 230 505

Ⓔ



▪ **Universal Positionslampe**

▪ **Universal position lamp**

Leuchtenfunktionen

Positionslicht
Rückstrahler

lighting functions

position light
reflector

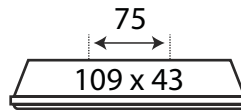

Anschlussspannung connection voltage	Anschlussart connection type	LED Anzahl LED number	Glasfarbe glass colour	Kabellänge cable length	Leuchtmittel illuminant	Art.-Nr. Part No.
12/24 V	Click-In	1	weiß white	500 mm	LED	098 230 562
12/24 V	Click-In	1	weiß white	5000 mm	LED	098 230 563

Ⓔ



▪ **Universal Positionslampe**

▪ **Universal position lamp**

Für horizontalen Anbau

For horizontal installation

Leuchtenfunktionen

Positionslicht
Rückstrahler

lighting functions

position light
reflector

Anschlussspannung connection voltage	LED Anzahl LED number	Glasfarbe glass colour	OE- Nr. OE- No.	Kabellänge cable length	Leuchtmittel illuminant	Art.-Nr. Part No.
12/24 V	3	weiß white	2PG 008 645-057	5000 mm	LED	098 231 875
12/24 V	3	weiß white	2PG 008 645-041	500 mm	LED	098 231 873

Zusatzartikel

Produktart product type	Artikeltitel article title	Anbauwinkel mounting bracket	Art.-Nr. Part No.
Montageteile mounting hardware	Winkelhalter mounting bracket	90°	098 291 278



Ⓔ



▪ **Universal
Positionsleuchte**

▪ **Universal
position lamp**

Leuchtenfunktionen

Positionslicht
Rückstrahler

lighting functions

position light
reflector

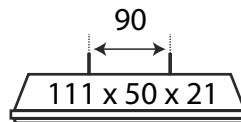

Anschlussspannung connection voltage	LED Anzahl LED number	Glasfarbe glass colour	OE- Nr. OE- No.	Kabellänge cable length	Leuchtmittel illuminant	Art.-Nr. Part No.
12/24 V	3	weiß white	2PG 963 639-401	500 mm	LED	098 230 960
12/24 V	3	weiß white		10000 mm	LED	098 230 964
12/24 V	3	weiß white	2PG 963 639-411	5000 mm	LED	098 230 961

Zusatzartikel

Produktart product type	Artikeltitel article title	OE- Nr. OE- No.	Art.-Nr. Part No.
Montageteile mounting hardware	Anbauwinkel mounting bracket	TA 342 120-010	098 291 949

Ⓔ



▪ **Universal
Positionsleuchte**

▪ **Universal
position lamp**

Leuchtenfunktionen

Positionslicht
Rückstrahler

lighting functions

position light
reflector

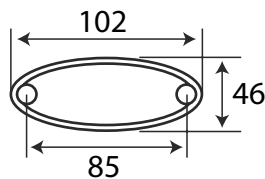

Anschlussspannung connection voltage	Anschlussart connection type	LED Anzahl LED number	Glasfarbe glass colour	Kabellänge cable length	Leuchtmittel illuminant	Art.-Nr. Part No.
12/24 V	Click-In	1	weiß white	500 mm	LED	098 230 523

Ⓔ



▪ **Universal
Positionsleuchte**

▪ **Universal
position lamp**

Leuchtenfunktionen

Positionslicht

lighting functions

position light

Anschlussspannung connection voltage	LED Anzahl LED number	Glasfarbe glass colour	Kabellänge cable length	Leuchtmittel illuminant	Art.-Nr. Part No.
24 V	6	weiß white	200 mm	LED	098 230 424
12 V	6	weiß white	200 mm	LED	098 230 422

Ⓔ



▪ **Universal
Positionsleuchte**

▪ **Universal
position lamp**

Leuchtenfunktionen

Positionslicht
Rückstrahler

lighting functions

position light
reflector

Anschlussleistung connected load	Anschlussspannung connection voltage	Anschlussart connection type	LED Anzahl LED number	Glasfarbe glass colour	OE- Nr. OE- No.	Leuchtmittel illuminant	Art.-Nr. Part No.
1.3 W	24 V	Bajonett Bayonet	1	weiß white	21 6601 004	LED	910 236 222

Ⓔ



▪ **Universal
Positionsleuchte**

▪ **Universal
position lamp**

Leuchtenfunktionen

Positionslicht
Rückstrahler

lighting functions

position light
reflector

Anschlussleistung connected load	Anschlussspannung connection voltage	Anschlussart connection type	LED Anzahl LED number	Glasfarbe glass colour	OE- Nr. OE- No.	Leuchtmittel illuminant	Art.-Nr. Part No.
1.3 W	24 V	Bajonett Bayonet	1	weiß white	21 6600 004	LED	910 236 223



Ⓔ



▪ **Universal Positionslampe**

▪ **Universal position lamp**

Leuchtenfunktionen	lighting functions
Positionslicht Rückstrahler	position light reflector

Anschlussleistung connected load	Anschlussspannung connection voltage	Anschlussart connection type	LED Anzahl LED number	Glasfarbe glass colour	OE- Nr. OE- No.	Kabellänge cable length	Leuchtmittel illuminant	Art.-Nr. Part No.
1.3 W	24 V	Click-In	1	weiß white	31 7704 037	1500 mm	LED	098 221 514

Ⓔ



▪ **Universal Positionslampe**

▪ **Universal position lamp**

Leuchtenfunktionen	lighting functions
Positionslicht	position light

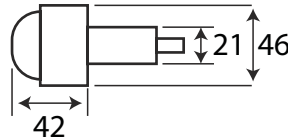

Anschlussspannung connection voltage	Glasfarbe glass colour	Art.-Nr. Part No.
12/24 V	weiß white	098 239 991

Zusatzartikel

Produktart product type	Artikeltitel article title	Sockelausführung socket version	Art.-Nr. Part No.
Fassungen bulb holder	Fassung bulb holder	BA15s	098 299 996
Fassungen bulb holder	Fassung bulb holder	BA15d	098 299 997
Lichtscheiben lens	Lichtscheibe lens		098 299 993

Ⓔ



▪ **Universal
Positionsleuchte**

▪ **Universal
position lamp**

Leuchtenfunktionen

Positionslicht

lighting functions

position light

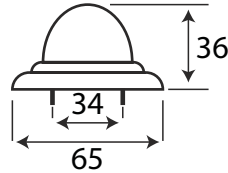

Sockelausführung socket version	Anschlussspannung connection voltage	Glasfarbe glass colour	OE- Nr. OE- No.	Art.-Nr. Part No.
SV8,5-36	12/24 V	weiß white	2PF 997 022-011 2PF 001 650-001	098 234 491

Zusatzartikel

Produktart product type	Artikeltitel article title	Art.-Nr. Part No.
Lichtscheiben lens	Lichtscheibe lens	098 294 499

Ⓔ



▪ **Universal
Positionsleuchte**

▪ **Universal
position lamp**

Leuchtenfunktionen

Positionslicht

lighting functions

position light

Zusätzl. Leuchtenfunktionen add. lighting functions	Sockelausführung socket version	Anschlussspannung connection voltage	Glasfarbe glass colour	OE- Nr. OE- No.	Art.-Nr. Part No.
	SV8,5-36	12/24 V	weiß white	2PF 003 057-001 2PF 003 057-041 9EL 117 330-001	098 230 805
Rückstrahler reflector	SV8,5-36	12/24 V	weiß white	2PG 003 057-067 2PG 003 057-061	098 230 800



(E)



▪ **Universal
Positionslampe**

▪ **Universal
position lamp**

Leuchtenfunktionen

Positionslicht

lighting functions

position light

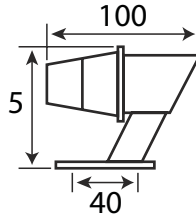

Sockelausführung socket version	Anschlussspannung connection voltage	Glasfarbe glass colour	Art.-Nr. Part No.
BA15s	12/24 V	weiß white	098 232 080

Zusatzartikel

Produktart product type	Artikeltitel article title	Art.-Nr. Part No.
Lichtscheiben lens	Lichtscheibe lens	098 292 089

(E)



▪ **Universal
Positionslampe**

▪ **Universal
position lamp**

Leuchtenfunktionen

Positionslicht

lighting functions

position light

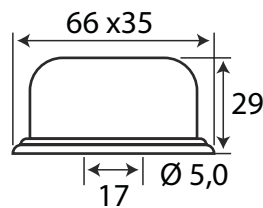

Sockelausführung socket version	Anschlussspannung connection voltage	Glasfarbe glass colour	Art.-Nr. Part No.
SV8,5-36	12/24 V	weiß white	098 231 551



▪ **Universal
Positionsleuchte**

Für horizontale und vertikale Montage

▪ **Universal
position lamp**

for horizontal and vertical installation

Leuchtenfunktionen

Positionslicht
Rückstrahler

lighting functions

position light
reflector

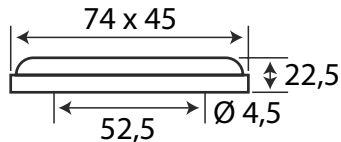

Sockelausführung socket version	Anschlussspannung connection voltage	Glasfarbe glass colour	Art.-Nr. Part No.
SV8,5-36	12/24 V	weiß white	j11.1001.001



▪ **Universal
Positionsleuchte**

Positionslicht
Rückstrahler

▪ **Universal
position lamp**

position light
reflector

Leuchtenfunktionen

lighting functions

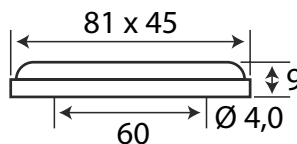

Sockelausführung socket version	Anschlussspannung connection voltage	Glasfarbe glass colour	Art.-Nr. Part No.
W2,1x9,5d	12/24 V	weiß white	098 232 373

Zusatzartikel

Produktart product type	Artikeltitel article title	Anschlussart connection type	Art.-Nr. Part No.
Fassungen bulb holder	Fassung bulb holder	Flachstecker 6,3mm flat connector 6.3mm	098 291 205



▪ **Universal
Positionsleuchte**

▪ **Universal
position lamp**

Leuchtenfunktionen

Positionslicht

lighting functions

position light

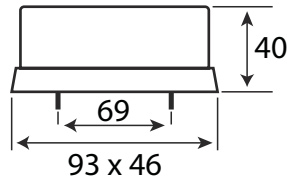

Sockelausführung socket version	Anschlussspannung connection voltage	Glasfarbe glass colour	Art.-Nr. Part No.
SV8,5-36	12/24 V	weiß white	098 236 794



▪ **Universal
Positionsleuchte**

▪ **Universal
position lamp**

Leuchtenfunktionen

Positionslicht
Rückstrahler

lighting functions

position light
reflector

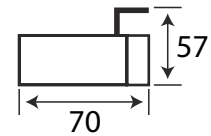
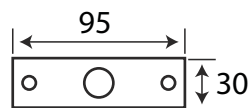

Sockelausführung socket version	Anschlussspannung connection voltage	Glasfarbe glass colour	OE- Nr. OE- No.	Art.-Nr. Part No.
BA9s	12/24 V	weiß white	21 5000 004	098 236 220



▪ **Universal
Positionsleuchte**

▪ **Universal
position lamp**

Leuchtenfunktionen

Positionslicht
Rückstrahler

lighting functions

position light
reflector

Befestigungsart mounting	Sockelausführung socket version	Anschlussspannung connection voltage	Glasfarbe glass colour	OE- Nr. OE- No.	Art.-Nr. Part No.
Anbauwinkel mounting bracket	BA9s	12/24 V	weiß white	21 5000 034	098 236 222

Zusatzartikel

Produktart product type	Artikeltitel article title	Glasfarbe glass colour	OE- Nr. OE- No.	Art.-Nr. Part No.
Fassungen bulb holder	Fassung bulb holder		15 2128 524	098 296 225
Streuscheiben lens	Streuscheibe lens	weiß white	21 5000 024	098 296 221



▪ **Universal
Positionsleuchte**

▪ **Universal
position lamp**

Leuchtenfunktionen

Positionslicht
Rückstrahler

lighting functions

position light
reflector

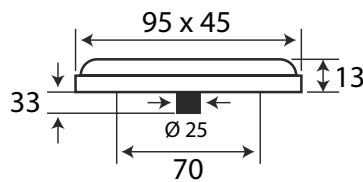

Sockelausführung socket version	Anschlussspannung connection voltage	Glasfarbe glass colour	Art.-Nr. Part No.
W2,9x9,5d	12/24 V	weiß white	098 230 290



FRONTBELEUCHTUNG
FRONT LIGHTS



■ **Universal
Positionsleuchte**

Für horizontale und vertikale Montage

Leuchtenfunktionen

Positionslicht
Rückstrahler

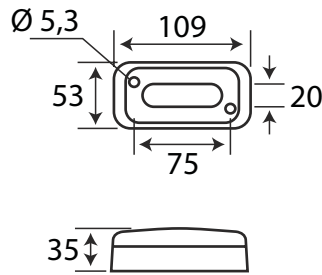

■ **Universal
position lamp**

For horizontal and vertical installation

lighting functions

position light
reflector

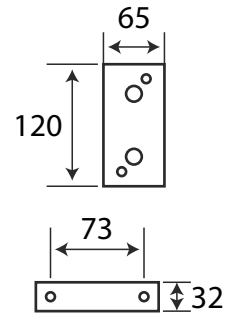

Sockelausführung socket version	Anschlussspannung connection voltage	Anschlussart connection type	Glasfarbe glass colour	Art.-Nr. Part No.
BA9s	12/24 V	Schraubanschluss PG7 Screw	weiß white	098 231 391

Zusatzartikel

Produktart product type	Artikeltitel article title	Glasfarbe glass colour	Art.-Nr. Part No.
Streuscheiben lens	Streuscheibe lens	weiß white	098 291 398

BESUCHEN SIE
UNSERE HOMEPAGE
WWW.FAHRZEUGBEDARF.AT





▪ **Universal Positionslampe**

▪ **Universal position lamp**

Leuchtenfunktionen	lighting functions
Positionslicht Rückstrahler	position light reflector

Befestigungsart mounting	Sockelausführung socket version	Anschlussspannung connection voltage	Anschlussart connection type	Glasfarbe glass colour	Art.-Nr. Part No.
Anbauwinkel mounting bracket	BA9s	12/24 V	Schraubanschluss PG7 screw connection PG7	weiß white	098 231 395

Zusatzartikel

Produktart product type	Artikeltitel article title	Glasfarbe glass colour	Art.-Nr. Part No.
Streuscheiben lens	Streuscheibe lens	weiß white	098 291 398
	PG-Verschraubung PG-connector		099 868 407



▪ **Universal Positionslampe**

▪ **Universal position lamp**

Leuchtenfunktionen	lighting functions
Positionslicht Rückstrahler	position light reflector

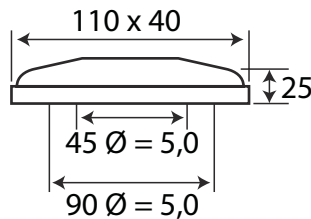

Sockelausführung socket version	Anschlussspannung connection voltage	Glasfarbe glass colour	Art.-Nr. Part No.
W2,1x9,5d	12/24 V	weiß white	098 230 297

Zusatzartikel

Produktart product type	Artikeltitel article title	Anbauwinkel mounting bracket	Art.-Nr. Part No.
Montageteile mounting hardware	Anbauwinkel mounting bracket	90	098 290 299



FRONTBELEUCHTUNG
FRONT LIGHTS



▪ **Universal Positionslampe**

▪ **Universal position lamp**

Leuchtenfunktionen	lighting functions
Positionslicht	position light

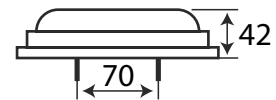
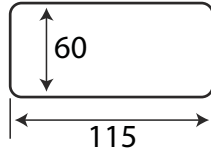

Sockelausführung socket version	Anschlussspannung connection voltage	Glasfarbe glass colour	Kabellänge cable length	Art.-Nr. Part No.
BA15s	12/24 V	weiß white	200 mm	098 231 452

Zusatzartikel

Produktart product type	Artikeltitel article title	Glasfarbe glass colour	Art.-Nr. Part No.
Streuscheiben lens	Streuscheibe lens	weiß white	098 291 459



▪ **Universal Positionslampe**

▪ **Universal position lamp**

Leuchtenfunktionen	lighting functions
Positionslicht	position light

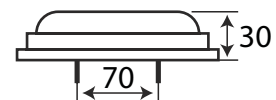
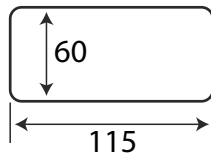

Sockelausführung socket version	Anschlussspannung connection voltage	Glasfarbe glass colour	Kabellänge cable length	Art.-Nr. Part No.
BA15s	12/24 V	weiß white	200 mm	098 231 459



▪ **Universal Fleximax ER-X
Positionsluchte**

▪ **Universal Fleximax ER-X
position lamp**

Leuchtenfunktionen

Positionslight

lighting functions

position light

Anschlussspannung connection voltage	LED Anzahl LED number	Glasfarbe glass colour	Kabellänge cable length	Leuchtmittel illuminant	Art.-Nr. Part No.
9-33 V	3	weiß white	500 mm	LED	098 233 400



▪ **Volvo FH, FL, FM
Positionsluchte**

▪ **Volvo FH, FL, FM
position lamp**

Positionsluchte vorne

position lamp, front

Leuchtenfunktionen

Positionslight

lighting functions

position light

80 x 38 x 25

Anschlussspannung connection voltage	LED Anzahl LED number	Glasfarbe glass colour	OE- Nr. OE- No.	Leuchtmittel illuminant	Art.-Nr. Part No.
24 V	2	weiß white	82116545	LED	098 231 820

Zusatzartikel

Produktart product type	Artikeltitel article title	Art.-Nr. Part No.
Stecker connector	KIT VOLVO NW 8,5	099 110 636



▪ **MB
Positionsluchte**

▪ **MB
position lamp**

Positionsluchte vorne mit
Gummiunterlage

position lamp, front with rubber base

Leuchtenfunktionen

Positionslight

lighting functions

position light

Anschlussspannung connection voltage	Anschlussart connection type	LED Anzahl LED number	Glasfarbe glass colour	OE- Nr. OE- No.	Leuchtmittel illuminant	Art.-Nr. Part No.
24 V	Flachstecker 6,3mm flat connector 6.3mm	2	weiß white	2PF 009 514-001	LED	098 242 910

TAGFAHRLEUCHTEN

DAYTIME RUNNING LIGHTS





▪ **Universal Tagfahrleuchte**

Schwarzes Kunststoffgehäuse mit Befestigungsschraube M8

Leuchtenfunktionen
Tagfahrlicht

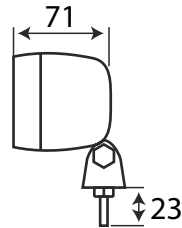

▪ **universal daytime running light**

Black plastic housing with M8 fixing screw

lighting functions
daytime running light

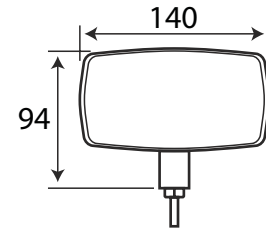

Sockelausführung socket version	Anschlussleistung connected load	Anschlussspannung connection voltage	Art.-Nr. Part No.
BA15s	21 W	12/24 V	098 256 011



▪ **Universal LED Tagfahrleuchte**

zur Nachrüstung

Leuchtenfunktionen
Tagfahrlicht

▪ **universal LED daytime running light**

for retrofitting

lighting functions
daytime running light

Anschlussspannung connection voltage	Leuchtmittel illuminant	Art.-Nr. Part No.
12/24 V	LED	098 256 520



▪ **Universal LED Tagfahrleuchte**

zur Nachrüstung, runde Ausführung

Leuchtenfunktionen
Tagfahrlicht

▪ **universal LED daytime running light**

for retrofitting, round execution

lighting functions
daytime running light

Anschlussleistung connected load	Anschlussspannung connection voltage	Leuchtmittel illuminant	Art.-Nr. Part No.
3 W	12/24 V	LED	098 256 530



FRONTBELEUCHTUNG
FRONT LIGHTS

(E)



▪ **Universal LED Tagfahrleuchte**

▪ *universal LED daytime running light*

Leuchtenfunktionen / *lighting functions*

Tagfahrlicht

daytime running light

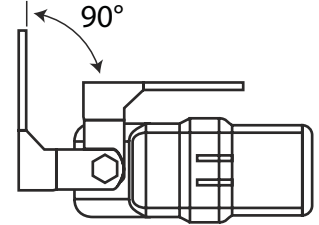
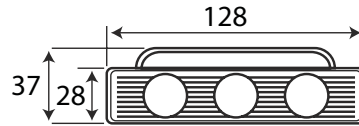

Anschlussleistung <i>connected load</i>	Anschlussspannung <i>connection voltage</i>	LED Anzahl <i>LED number</i>	Kabellänge <i>cable length</i>	Leuchtmittel <i>illuminant</i>	Art.-Nr. <i>Part No.</i>
3.7 W	12-36 V	3	3500 mm	LED	098 256 500



Fahrzeugbedarf
Division R.A.L. Handel



BLINKLEUCHTEN

INDICATOR LAMPS





Ⓔ



▪ **Scania 4 P, G, R, T 04-08
Blinkleuchten**

▪ **Scania 4 P, G, R, T 04-08
indicator lamp**

Leuchtenfunktionen	lighting functions
Positionslicht	position light
Blinklicht	indicator

OE- Nr. OE- No.	Anbauseite installation side	Art.-Nr. Part No.
1385 410	◀ L	098 293 014
1387 155 1337 250	▶ R	098 293 015

Zusatzartikel

Produktart product type	Artikeltitel article title	OE- Nr. OE- No.	Art.-Nr. Part No.
Anschlusskabel connection wire	Anschlusskabel mit Fassung connection wire with holder	1 732 515 1 467 007 1 385 411	098 109 969

Ⓔ



▪ **Volvo FH, FM 93-01
Blinkleuchten**

▪ **Volvo FH, FM 93-01
indicator lamp**

Leuchtenfunktionen	lighting functions
Positionslicht	position light
Blinklicht	indicator

Anschlussart connection type	OE- Nr. OE- No.	Art.-Nr. Part No.
Flachstecker 6,3mm flat connector 6.3mm	398 16 68	098 223 050

Zusatzartikel

Artikeltitel article title	OE- Nr. OE- No.	Sockelausführung socket version	Art.-Nr. Part No.
Fassung bulb holder	3090 948	BA15s	098 299 973



▪ **ER-X LT3
Blinkleuchten**

▪ **ER-X LT3
indicator lamp**

Leuchtenfunktionen

Positionslicht
Blinklicht

lighting functions

position light
indicator

Anschlussspannung connection voltage	Anschlussart connection type	Glasfarbe glass colour	OE- Nr. OE- No.	Art.-Nr. Part No.
12/24 V	AMP Superseal Kabeldurchführung AMP Superseal wire bushing	orange, weiß amber, white	2BE 343 130-001 2BE 343 130-657	098 222 140



▪ **Steyr - Case
Blinkleuchten**

▪ **Steyr - Case
indicator lamp**

Leuchtenfunktionen

Positionslicht
Blinklicht

lighting functions

position light
indicator

Sockelausführung socket version	Anschlussleistung connected load	Anschlussspannung connection voltage	Anbauseite installation side	Art.-Nr. Part No.
BAU15s BA15s	21/5 W	12/24 V	◀ L	910 222 120
BAU15s BA15s	21/5 W	12/24 V	▶ R	910 222 122

Zusatzartikel

Produktart product type	Artikeltitel article title	Art.-Nr. Part No.
Lichtscheiben lens	Lichtscheibe lens	910 292 125



Ⓔ



▪ **Universal
Blinkleuchten**

▪ *universal
indicator lamp*

Leuchtenfunktionen

Positionslicht
Blinklicht

lighting functions

*position light
indicator*

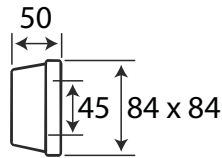

Sockelausführung socket version	Anschlussspannung connection voltage	OE- Nr. OE- No.	Art.-Nr. Part No.
BA15s SV8,5-36	12/24 V	2BE003014-251	098 227 020

Ⓔ



▪ **Universal
Blinkleuchten**

▪ *universal
indicator lamp*

Leuchtenfunktionen

Positionslicht
Blinklicht

lighting functions

*position light
indicator*

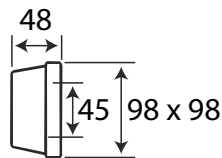

Sockelausführung socket version	Anschlussspannung connection voltage	OE- Nr. OE- No.	Art.-Nr. Part No.
BA15s SV8,5-36	12/24 V	22.093-041	098 222 190

Ⓔ



▪ **Universal
Blinkleuchten**

▪ *universal
indicator lamp*

Leuchtenfunktionen

Positionslicht
Blinklicht

lighting functions

*position light
indicator*

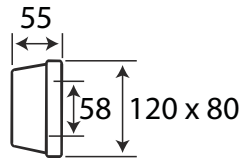

Sockelausführung <i>socket version</i>	Anschlussleistung <i>connected load</i>	Anschlussspannung <i>connection voltage</i>	OE- Nr. <i>OE- No.</i>	Art.-Nr. <i>Part No.</i>
BA15s	21/5 W	12/24 V	2BE997131-081	098 222 130

Zusatzartikel

Produktart <i>product type</i>	Artikeltitel <i>article title</i>	Art.-Nr. <i>Part No.</i>
Lichtscheiben <i>lens</i>	Lichtscheibe <i>lens</i>	098 292 132

Ⓔ



▪ **Universal
Blinkleuchten**



▪ *universal
indicator lamp*

Leuchtenfunktionen

Positionslicht
Blinklicht

lighting functions

*position light
indicator*

Sockelausführung <i>socket version</i>	Anschlussleistung <i>connected load</i>	Anschlussspannung <i>connection voltage</i>	Anbauseite <i>installation side</i>	Art.-Nr. <i>Part No.</i>
BA15s	21/5 W	12/24 V		098 218 271
BA15s	21/5 W	12/24 V		098 218 270

Zusatzartikel

Produktart <i>product type</i>	Artikeltitel <i>article title</i>	Art.-Nr. <i>Part No.</i>
Lichtscheiben <i>lens</i>	Lichtscheibe <i>lens</i>	098 292 132



9x IN FOLGE **BESTE MARKE**

Kategorie Trailerachsen
BPW Bergische Achsen

MEHRKAMMERLEUCHTEN

MULTI-CHAMBER LIGHTS





HECKBELEUCHTUNG
REAR LIGHTS



▪ **DAF Universal Mehrkammerleuchte**

▪ **DAF Universal multi-chamber lights**

Leuchtenfunktionen **lighting functions**

- | | |
|-------------------|----------------|
| Blinklicht | indicator |
| Bremslicht | stoplight |
| Schlusslicht | tail light |
| Schlusslicht 2 | 2. tail light |
| Rückfahrlicht | reverse light |
| Nebelschlusslicht | fog tail light |
| Rückstrahler | reflector |

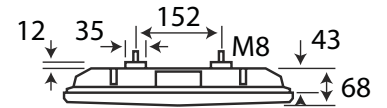
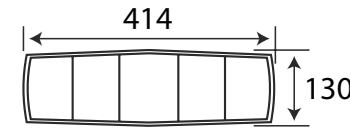

Zusätzl. Leuchtenfunktionen <i>add. lighting functions</i>	Anschlussart <i>connection type</i>	OE- Nr. <i>OE- No.</i>	Art.-Nr. <i>Part No.</i>
Kennzeichenlicht <i>licence plate light</i>	Kabeldurchführung <i>wire bushing</i>	289224	098 212 770

Zusatzartikel

Produktart <i>product type</i>	Artikeltitel <i>article title</i>	OE- Nr. <i>OE- No.</i>	Art.-Nr. <i>Part No.</i>
Lichtscheiben <i>lens</i>	Lichtscheibe <i>lens</i>	81.25229-6036	098 292 773
		81.25229-6040	



▪ **DAF 65/75/85/95, CF/XF, 95XF/105XF, Universal Mehrkammerleuchte**

▪ **DAF 65/75/85/95 > CF/XF > 95XF/105XF > Universal multi-chamber lights**

Leuchtenfunktionen **lighting functions**

- | | |
|------------------------|-------------------|
| Blinklicht | indicator |
| Schlusslicht | tail light |
| Bremslicht | stoplight |
| Schlusslicht 2 | 2. tail light |
| Rückfahrlicht | reverse light |
| Nebelschlusslicht | fog tail light |
| Rückstrahler | reflector |
| Positionslicht | position light |
| Seitenmarkierungslicht | side marker light |

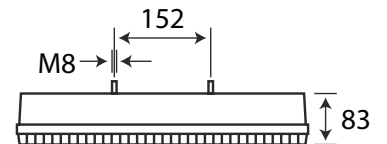
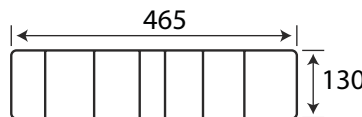

Zusätzl. Leuchtenfunktionen <i>add. lighting functions</i>	Anschlussart <i>connection type</i>	OE- Nr. <i>OE- No.</i>	Steckerbelegung <i>pin assignment</i>	Anbauseite <i>installation side</i>	Art.-Nr. <i>Part No.</i>
	Stecker 6-polig System "Schlemmer" 6-pole connector system "Schlemmer"	81.25228 6030			098 212 953

- DAF 65/75/85/95, CF/XF, 95XF/ 105XF, Universal Mehrkammerleuchte
- DAF 65/75/85/95 > CF/XF > 95XF/105XF > Universal multi-chamber lights

Zusätzl. Leuchtenfunktionen <i>add. lighting functions</i>	Anschlussart <i>connection type</i>	OE- Nr. <i>OE- No.</i>	Steckerbelegung <i>pin assignment</i>	Anbauseite <i>installation side</i>	Art.-Nr. <i>Part No.</i>
Kennzeichenlicht <i>licence plate light</i>	Stecker 6-polig System "Schlemmer" 6-pole connector system "Schlemmer"	81.25228 6029		◀ L	098 212 954
	AMP 1.5	1284212		▶ R	098 212 806
Kennzeichenlicht <i>licence plate light</i>	AMP 1.5	1284211		◀ L	098 212 807
Kennzeichenlicht <i>licence plate light</i>	AMP 1.5 90°	81.25225 6524 500 184 7584		◀ L	098 212 956
	AMP 1.5 90°	81.25225 6523 500 184 7585		▶ R	098 212 957

Zusatzartikel

Produktart <i>product type</i>	Artikeltitel <i>article title</i>	OE- Nr. <i>OE- No.</i>	Anschlussart <i>connection type</i>	Art.-Nr. <i>Part No.</i>
Stecker connector	Stecker System SCHLEMMER		AMP 1.5 90°	098 292 775
Stecker connector	KIT NW 10 Renault, Volvo, DAF LF		AMP 1.5 90°	099 111 493
Lichtscheiben lens	Lichtscheibe für Rückstrahler und Seitenmarkierungsleuchte lens for reflex reflector and side marker lamp			098 292 959
Lichtscheiben lens	Lichtscheibe lens	127 26 53 135 03 43 152 51 77 500 184 7588 81.25229-6051 81.25229-6052 81.25229-6055 8142919 931 61 844		098 292 793
Stecker connector	KIT MAN TG-A NW 8,5 gerade		AMP 1.5 180°	099 111 648



▪ DAF LF 45/55
Mehrkammerleuchte

▪ DAF LF 45/55
multi-chamber lights

Leuchtenfunktionen	lighting functions
Blinklicht	indicator
Schlusslicht	tail light
Bremslicht	stoplight
Schlusslicht 2	2. tail light
Rückfahrlicht	reverse light
Nebelschlusslicht	fog tail light
Rückstrahler	reflector

Zusätzl. Leuchtenfunktionen add. lighting functions	Anschlussart connection type	OE- Nr. OE- No.	Steckerbelegung pin assignment	Anbauseite installation side	Art.-Nr. Part No.
Kennzeichenlicht licence plate light	AMP 1.5	20769783 140 1713			098 212 910
	AMP 1.5	20769784 140 1731			098 212 912

Zusatzartikel

Produktart product type	Artikeltitel article title	OE- Nr. OE- No.	Anschlussart connection type	Art.-Nr. Part No.
Stecker connector	KIT NW 10 Renault, Volvo, DAF LF		AMP 1.5 90°	099 111 493
Lichtscheiben lens	Lichtscheibe lens	42566495 42535711 1451482		098 292 919



▪ DAF CF/XF 09/2011
Mehrkammerleuchte

▪ DAF CF/XF 09/2011
multi-chamber lights

Leuchtenfunktionen

- Blinklicht
- Bremslicht
- Schlusslicht
- Schlusslicht 2
- Rückfahrlicht
- Nebelschlusslicht
- Seitenmarkierungslicht
- Rückstrahler

lighting functions

- indicator
- stoplight
- tail light
- 2. tail light
- reverse light
- fog tail light
- side marker light
- reflector

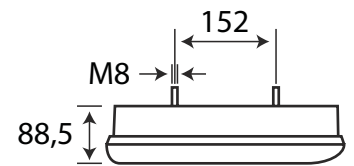
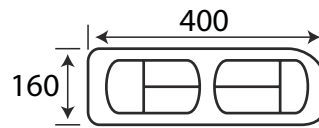

Zusätzl. Leuchtenfunktionen add. lighting functions	Anschlussart connection type	OE- Nr. OE- No.	Anbauseite installation side	Art.-Nr. Part No.
	Stecker HDS CS seitlich connector HDS CS lateral	1875576	R	098 212 903
Kennzeichenlicht licence plate light	Stecker HDS CS seitlich connector HDS CS lateral	1875577	L	098 212 904
Rückfahrwarner back-up warning	Stecker HDS CS seitlich connector HDS CS lateral	1875578	R	098 212 905
	Stecker HDS CS seitlich connector HDS CS lateral	1875579	R	098 212 906
Kennzeichenlicht licence plate light	Stecker HDS CS seitlich connector HDS CS lateral	1875580	L	098 212 907
Rückfahrwarner back-up warning	Stecker HDS CS seitlich connector HDS CS lateral	1875581	R	098 212 908



▪ **DAF LC11**
Mehrkammerleuchte

▪ **DAF LC11**
multi-chamber lights

Leuchtenfunktionen	lighting functions
Blinklicht	indicator
Schlusslicht	tail light
Bremslicht	stoplight
Nebelschlusslicht	fog tail light
Rückfahrlicht	reverse light

Zusätzl. Leuchtenfunktionen add. lighting functions	Anschlussart connection type	Anbauseite installation side	Art.-Nr. Part No.
Kennzeichenlicht licence plate light	Stecker HDS CS seitlich connector HDS CS lateral	◀ L	098 215 910
	Stecker HDS CS seitlich connector HDS CS lateral	▶ R	098 215 911
Kennzeichenlicht licence plate light	Stecker HDS CS hinten connector HDS CS behind	◀ L	098 215 920
	Stecker HDS CS hinten connector HDS CS behind	▶ R	098 215 921



▪ **IVECO Eurocargo, Daily 84 > 9/99, Daily S 2000 >**
Mehrkammerleuchte



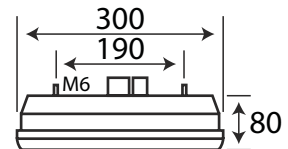
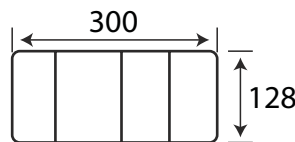

▪ **IVECO Eurocargo, Daily 84 > 9/99, Daily S 2000 >**
multi-chamber lights

Leuchtenfunktionen	lighting functions
Blinklicht	indicator
Bremslicht	stoplight
Schlusslicht	tail light
Schlusslicht 2	2. tail light
Rückstrahler	reflector



Zusätzl. Leuchtenfunktionen add. lighting functions	Anschlussart connection type	OE- Nr. OE- No.	Steckerbelegung pin assignment	Anbauseite installation side	Art.-Nr. Part No.
	Stecker Olsa connector Olsa	98424051		▶ R	098 212 830
Nebelschlusslicht fog tail light	Stecker Olsa connector Olsa	98424052		◀ L	098 212 835

- IVECO Eurocargo, Daily 84 > 9/99, Daily S 2000 > Mehrkammerleuchte
- IVECO Eurocargo, Daily 84 > 9/99, Daily S 2000 > multi-chamber lights

Zusätzl. Leuchtenfunktionen <i>add. lighting functions</i>	Anschlussart <i>connection type</i>	OE- Nr. <i>OE- No.</i>	Steckerbelegung <i>pin assignment</i>	Anbauseite <i>installation side</i>	Art.-Nr. <i>Part No.</i>
Rückfahrlicht reverse light	Stecker 5-polig 5-pole connector	1904639		R	098 212 840
Nebelschlusslicht fog tail light	Stecker 5-polig 5-pole connector	1904640		L	098 212 845
Rückfahrlicht reverse light	AMP 1.5			R	098 212 843
Nebelschlusslicht fog tail light	AMP 1.5			L	098 212 848

Zusatzartikel

Produktart <i>product type</i>	Artikeltitel <i>article title</i>	OE- Nr. <i>OE- No.</i>	Anbauseite <i>installation side</i>	Art.-Nr. <i>Part No.</i>
Stecker connector	KIT Iveco Cargo, Stralis, Eurotech			099 110 647
Stecker connector	KIT Iveco Cargo, Stralis, Eurotech			099 110 049
Lichtscheiben lens	Lichtscheibe lens	42471137	R	098 292 842
Lichtscheiben lens	Lichtscheibe lens	42471138	L	098 292 847

**INFORMIEREN SIE SICH
AUCH ÜBER UNSEREN
FAHRZEUGAUSRÜSTUNGSKATALOG**

WWW.RAL.AT





(E)



▪ Iveco Eurocargo 06.2011 > Mehrkammerleuchte

▪ Iveco Eurocargo 06.2011 > multi-chamber lights

Leuchtenfunktionen

Blinklicht
Bremslicht
Schlusslicht
Schlusslicht 2
Rückfahrlicht
Nebelschlusslicht

lighting functions

indicator
stoplight
tail light
2. tail light
reverse light
fog tail light

Zusätzl. Leuchtenfunktionen add. lighting functions	Anschlussart connection type	OE- Nr. OE- No.	Anbauseite installation side	Art.-Nr. Part No.
Kennzeichenlicht licence plate light	AMP 1.5	5801426912	◀ L	098 212 983
	AMP 1.5	5801426894	▶ R	098 212 984
	AMP 1.5	5801426889	◀ L	098 212 985
Rückfahrwarner back-up warning	AMP 1.5	5801426917	▶ R	098 212 986

Zusatzartikel

Produktart product type	Artikeltitel article title	OE- Nr. OE- No.	Art.-Nr. Part No.
Lichtscheiben lens	Lichtscheibe lens	42566495 42535711 1451482	098 292 919



■ IVECO Eurotech
 Mehrkammerleuchte

■ IVECO Eurotech
 multi-chamber lights

Leuchtenfunktionen

- Blinklicht
- Blinklicht
- Schlusslicht
- Schlusslicht 2
- Rückfahrlicht
- Rückstrahler
- Nebelschlusslicht

lighting functions

- indicator
- indicator
- tail light
- 2. tail light
- reverse light
- reflector
- fog tail light

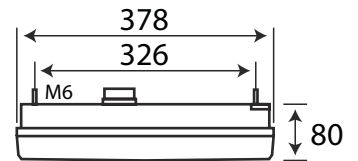
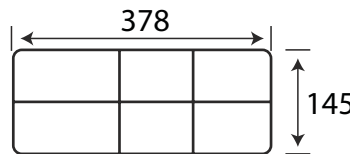

Anschlussart <i>connection type</i>	Steckerbelegung <i>pin assignment</i>	Anbauseite <i>installation side</i>	Art.-Nr. <i>Part No.</i>
Stecker Olsa connector Olsa		◀ L	098 212 855
Stecker Olsa connector Olsa		▶ R	098 212 865

Zusatzartikel

Produktart <i>product type</i>	Artikeltitel <i>article title</i>	Anbauseite <i>installation side</i>	Art.-Nr. <i>Part No.</i>
Lichtscheiben lens	Lichtscheibe lens	◀ L	098 292 852
Lichtscheiben lens	Lichtscheibe lens	▶ R	098 292 862



▪ IVECO > 09/2011
Mehrkammerleuchte

▪ IVECO > 09/2011
multi-chamber lights

Leuchtenfunktionen	lighting functions
Blinklicht	indicator
Bremslicht	stoplight
Schlusslicht	tail light
Schlusslicht 2	2. tail light
Rückfahrlicht	reverse light
Nebelschlusslicht	fog tail light
Positionslicht	position light
Seitenmarkierungslicht	side marker light
Rückstrahler	reflector

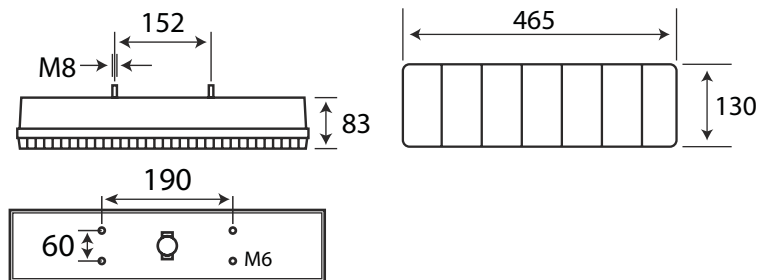

Zusätzl. Leuchtenfunktionen add. lighting functions	Anschlussart connection type	OE- Nr. OE- No.	Steckerbelegung pin assignment	Anbauseite installation side	Art.-Nr. Part No.
	Stecker Olsa connector Olsa	99453242 99463242		R	098 212 961
Kennzeichenlicht licence plate light	Stecker Olsa connector Olsa	99463244		L	098 212 962
	AMP 1.5	5801363428		L	098 212 991
Kennzeichenlicht licence plate light	AMP 1.5	5801363430		L	098 212 993
	AMP 1.5	5801363431		R	098 212 992
Rückfahrwarner back-up warning	AMP 1.5	5801363432		R	098 212 994

Zusatzartikel

Produktart product type	Artikeltitel article title	OE- Nr. OE- No.	Art.-Nr. Part No.
Stecker connector	KIT Iveco Cargo, Stralis, Eurotech		099 110 647
Lichtscheiben lens	Lichtscheibe für Rückstrahler und Seitenmarkierungs- leuchte lens for reflex reflector and side marker lamp		098 292 959
Lichtscheiben lens	Lichtscheibe lens	127 26 53 135 03 43 152 51 77 500 184 7588 81.25229-6051 81.25229-6052 81.25229-6055 8142919 931 61 844	098 292 793



▪ Iveco Daily 2006 > Pritsche
 Mehrkammerleuchte

▪ Iveco Daily 2006 > Platform
 multi-chamber lights

Leuchtenfunktionen

Blinklicht
 Bremslicht
 Schlusslicht
 Nebelschlusslicht
 Rückfahrlicht

lighting functions

indicator
 stoplight
 tail light
 fog tail light
 reverse light

Anschlussart <i>connection type</i>	OE- Nr. <i>OE- No.</i>	Anbauseite <i>installation side</i>	Art.-Nr. <i>Part No.</i>
AMP 1.5	69 500 032	◀ L	098 214 052
AMP 1.5	69 500 026	▶ R	098 214 053

Zusatzartikel

Produktart <i>product type</i>	Artikeltitel <i>article title</i>	Anschlussart <i>connection type</i>	Art.-Nr. <i>Part No.</i>
Stecker connector	KIT NW 10 Renault, Volvo, DAF LF	AMP 1.5 90°	099 111 493
Lichtscheiben lens	Lichtscheibe lens		098 294 055



▪ Iveco Daily Kastenwagen 3,5t
Mehrkammerleuchte

▪ Iveco Daily Van 3,5t
multi-chamber lights

Leuchtenfunktionen	lighting functions
Blinklicht	indicator
Bremslicht	stoplight
Schlusslicht	tail light
Nebelschlusslicht	fog tail light
Rückfahrlicht	reverse light

OE- Nr. OE- No.	Anbauseite installation side	Art.-Nr. Part No.
695 00 590	◀ L	098 214 055
695 00 591	▶ R	098 214 056

Zusatzartikel

Produktart product type	Artikeltitel article title	Anschlussart connection type	Art.-Nr. Part No.
Stecker connector	KIT Steckdose SUPER SEAL KIT plug SUPER SEAL		099 111 106
Stecker connector	KIT SUPER SEAL		099 110 019



▪ **Renault Trucks**
Mehrkammerleuchte

▪ **Renault Trucks**
multi-chamber lights

Leuchtenfunktionen

- Blinklicht
- Bremslicht
- Schlusslicht
- Schlusslicht 2
- Rückfahrlicht
- Nebelschlusslicht
- Rückstrahler

lighting functions

- indicator*
- stoplight*
- tail light*
- 2. tail light*
- reverse light*
- fog tail light*
- reflector*

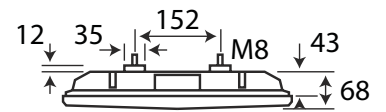
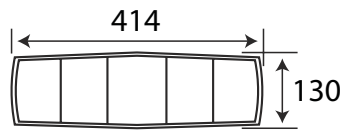

Zusätzl. Leuchtenfunktionen <i>add. lighting functions</i>	Anschlussart <i>connection type</i>	OE- Nr. <i>OE- No.</i>	Art.-Nr. <i>Part No.</i>
Kennzeichenlicht <i>licence plate light</i>	Kabeldurchführung <i>wire bushing</i>	289224	098 212 770

Zusatzartikel

Produktart <i>product type</i>	Artikeltitel <i>article title</i>	OE- Nr. <i>OE- No.</i>	Art.-Nr. <i>Part No.</i>
Lichtscheiben <i>lens</i>	Lichtscheibe <i>lens</i>	81.25229-6036 81.25229-6040	098 292 773



▪ Renault Trucks Magnum, Premium, Kerax 2006 > Mehrkammerleuchte

▪ Renault Trucks Magnum, Premium, Kerax 2006 > multi-chamber lights

Leuchtenfunktionen

- Blinklicht
- Bremslicht
- Schlusslicht
- Schlusslicht 2
- Seitenmarkierungslicht
- Rückstrahler

lighting functions

- indicator
- stoplight
- tail light
- 2. tail light
- side marker light
- reflector

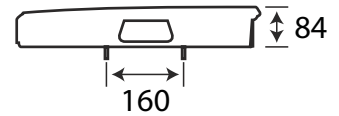
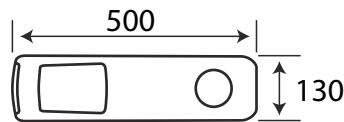

Zusätzl. Leuchtenfunktionen <i>add. lighting functions</i>	Steckerposition <i>connector position</i>	Anschlussart <i>connection type</i>	OE- Nr. <i>OE- No.</i>	Steckerbelegung <i>pin assignment</i>	Anbauseite <i>installation side</i>	Art.-Nr. <i>Part No.</i>
Nebelschlusslicht fog tail light	seitlich lateral	AMP 1.5	742 080 2348 20802346		◀ L	098 212 900
Nebelschlusslicht Kennzeichenlicht fog tail light licence plate light	seitlich lateral	AMP 1.5	742 080 2350 20802350		▶ R	098 212 901
Rückfahrlicht Rückfahrwarner reverse light back-up warning	seitlich lateral	AMP 1.5	742 080 2353 20802353		▶ R	098 212 902

Zusatzartikel

Produktart <i>product type</i>	Artikeltitel <i>article title</i>	OE- Nr. <i>OE- No.</i>	Anschlussart <i>connection type</i>	Art.-Nr. <i>Part No.</i>
Lichtscheiben lens	Lichtscheibe lens	20802418 742 080 2418		098 292 903
Stecker connector	KIT NW 10 Renault, Volvo, DAF LF		AMP 1.5 90°	099 111 493
Stecker connector	KIT NW 10 Renault, Volvo, DAF LF		AMP 1.5 180°	099 110 619



▪ **Renault Trucks**
Mehrkammerleuchte

▪ **Renault Trucks**
multi-chamber lights

Leuchtenfunktionen

- Blinklicht
- Schlusslicht
- Bremslicht
- Schlusslicht 2
- Rückfahrlicht
- Nebelschlusslicht
- Rückstrahler
- Seitenmarkierungslicht

lighting functions

- indicator
- tail light
- stoplight
- 2. tail light
- reverse light
- fog tail light
- reflector
- side marker light

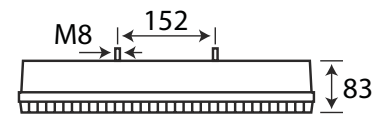
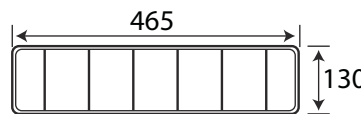

Zusätzl. Leuchtenfunktionen add. lighting functions	Anschlussart connection type	OE- Nr. OE- No.	Steckerbelegung pin assignment	Anbauseite installation side	Art.-Nr. Part No.
Kennzeichenlicht licence plate light	AMP 1.5 90°	81.25225 6524 500 184 7584			098 212 956
	AMP 1.5 90°	81.25225 6523 500 184 7585			098 212 957

Zusatzartikel

Produktart product type	Artikeltitel article title	OE- Nr. OE- No.	Art.-Nr. Part No.
Lichtscheiben lens	Lichtscheibe lens	127 26 53 135 03 43 152 51 77 500 184 7588 81.25229-6051 81.25229-6052 81.25229-6055 8142919 931 61 844	098 292 793



MAN TG-A, TG-L, TG-M, TG-S, TG-X
Mehrkammerleuchte

MAN TG-A, TG-L, TG-M, TG-S, TG-X
multi-chamber lights

Leuchtenfunktionen	lighting functions
Blinklicht	indicator
Bremslicht	stoplight
Schlusslicht	tail light
Schlusslicht 2	2. tail light
Rückfahrlicht	reverse light
Nebelschlusslicht	fog tail light
Seitenmarkierungslicht	side marker light
Rückstrahler	reflector

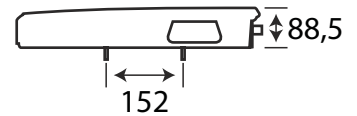
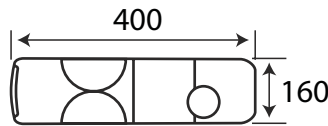

Zusätzl. Leuchtenfunktionen add. lighting functions	Steckerposition connector position	Anschlussart connection type	OE- Nr. OE- No.	Steckerbelegung pin assignment	Anbauseite installation side	Art.-Nr. Part No.
Kennzeichenlicht licence plate light	seitlich lateral	AMP 1.5	81.25225-6544			098 212 890
	seitlich lateral	AMP 1.5	81.25225-6545			098 212 891
Rückfahrwarner back-up warning	seitlich lateral	AMP 1.5	81.25225-6547			098 212 892

Zusatzartikel

Produktart product type	Artikeltitel article title	Kabellänge cable length	OE- Nr. OE- No.	Anbauseite installation side	Anschlussart connection type	Art.-Nr. Part No.
Lichtscheiben lens	Lichtscheibe lens		81.25225-6059 81.25229-6059			098 292 898
Lichtscheiben lens	Lichtscheibe lens		81.25225-6060 81.25229-6060			098 292 899
Stecker connector	KIT MAN TG-A NW 8,5 gerade				AMP 1.5 180°	099 111 648
Anschlusskabel connection wire	Anschlusskabel connection wire	4000 mm				098 291 233
	Vorschaltgerät converter					098 400 020
	Rückfahrwarner back-up warning		81.25305-0000			090 450 995



▪ **MAN TG-A, TG-L, TG-M, TG-S, TG-X, Scania, DAF, Renault Mehrkammerleuchte**

auch einsetzbar für Scania, DAF & Renault
 Betriebsdauer der LED: ca. 30.000 Stunden

▪ **MAN TG-A, TG-L, TG-M, TG-S, TG-X multi-chamber lights**

also useable for Scania, DAF & Renault
 operating time LED: ca. 30.000 hours

Leuchtenfunktionen	lighting functions
Blinklicht	indicator
Bremslicht	stoplight
Schlusslicht	tail light
Schlusslicht 2	2. tail light
Rückfahrlicht	reverse light
Nebelschlusslicht	fog tail light
Rückfahrwarner	back-up warning
Seitenmarkierungslicht	side marker light
Rückstrahler	reflector

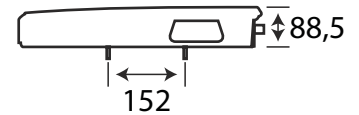
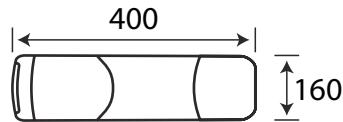

Zusätzl. Leuchtenfunktionen add. lighting functions	Steckerposition connector position	Steckerbelegung pin assignment	Leuchtmittel illuminant	Anbauseite installation side	Art.-Nr. Part No.
Kennzeichenlicht licence plate light	seitlich lateral		LED		098 215 890
	seitlich lateral		LED		098 215 891

Zusatzartikel

Produktart product type	Artikeltitel article title	Kabellänge cable length	Anschlussart connection type	Art.-Nr. Part No.
Stecker connector	KIT MAN TG-A NW 8,5 gerade		AMP 1.5 180°	099 111 648
	Anschlusskabel connection wire	4000 mm		098 291 233
	Vorschaltgerät converter			098 400 020



MAN F2000
Mehrkammerleuchte

MAN F2000
multi-chamber lights

Leuchtenfunktionen	lighting functions
Blinklicht	indicator
Schlusslicht	tail light
Bremslicht	stoplight
Schlusslicht 2	2. tail light
Rückfahrlicht	reverse light
Nebelschlusslicht	fog tail light
Rückstrahler	reflector
Positionslicht	position light
Seitenmarkierungslicht	side marker light

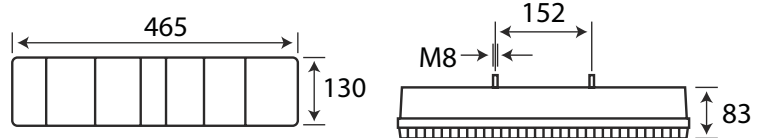

Zusätzl. Leuchtenfunktionen add. lighting functions	Anschlussart connection type	OE- Nr. OE- No.	Steckerbelegung pin assignment	Leuchtmittel illuminant	Anbauseite installation side	Art.-Nr. Part No.
	Stecker 6-polig System "Schlemmer" 6-pole connector system "Schlemmer"	81.25228 6030				098 212 953
Kennzeichenlicht licence plate light	Stecker 6-polig System "Schlemmer" 6-pole connector system "Schlemmer"	81.25228 6029			◀ L	098 212 954
	Stecker 6-polig System "Schlemmer" 6-pole connector system "Schlemmer"			LED	▶ R	098 215 953
Kennzeichenlicht licence plate light	Stecker 6-polig System "Schlemmer" 6-pole connector system "Schlemmer"			LED	◀ L	098 215 954

Zusatzartikel

Produktart product type	Artikeltitel article title	OE- Nr. OE- No.	Art.-Nr. Part No.
Lichtscheiben lens	Lichtscheibe für Rückstrahler und Seitenmarkierungsleuchte lens for reflex reflector and side marker lamp		098 292 959
Lichtscheiben lens	Lichtscheibe lens	127 26 53 135 03 43 152 51 77 500 184 7588 81.25229-6051 81.25229-6052 81.25229-6055 8142919 931 61 844	098 292 793



■ **MAN TG Serie, LE 2000**
Mehrkammerleuchte

■ **MAN TG Serie, LE 2000**
multi-chamber lights

Leuchtenfunktionen

- Blinklicht
- Schlusslicht
- Bremslicht
- Schlusslicht 2
- Rückfahrlicht
- Nebelschlusslicht
- Rückstrahler
- Positionslicht
- Seitenmarkierungslicht

lighting functions

- indicator
- tail light
- stoplight
- 2. tail light
- reverse light
- fog tail light
- reflector
- position light
- side marker light

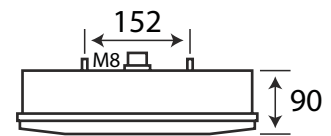
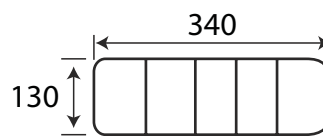

Zusätzl. Leuchtenfunktionen add. lighting functions	Anschlussart connection type	OE- Nr. OE- No.	Steckerbelegung pin assignment	Anbauseite installation side	Art.-Nr. Part No.
Kennzeichenlicht licence plate light	Stecker 6-polig System "Schlemmer" 6-pole connector system "Schlemmer"	81.25225 6531		◀ L	910 213 050
Kennzeichenlicht licence plate light	Stecker 6-polig System "Schlemmer" 6-pole connector system "Schlemmer"	81.25225 6532		▶ R	910 213 051

Zusatzartikel

Produktart product type	Artikeltitel article title	OE- Nr. OE- No.	Anschlussart connection type	Art.-Nr. Part No.
Stecker connector	KIT MAN TG-A NW 8,5 gerade		AMP 1.5 180°	099 111 648
Lichtscheiben lens	Lichtscheibe für Rückstrahler und Seitenmarkierungs- leuchte lens for reflex reflector and side marker lamp			098 292 959
Lichtscheiben lens	Lichtscheibe lens	002 544 6190 81.25225-6538		098 293 182



Ⓔ



▪ Scania 3,4,P/G/R/T
Mehrkammerleuchte

▪ Scania 3,4,P/G/R/T
multi-chamber lights

Leuchtenfunktionen	lighting functions
Blinklicht	indicator
Bremslicht	stoplight
Schlusslicht	tail light
Schlusslicht 2	2. tail light
Rückfahrlicht	reverse light
Nebelschlusslicht	fog tail light
Positionslicht	position light
Seitenmarkierungslicht	side marker light
Rückstrahler	reflector

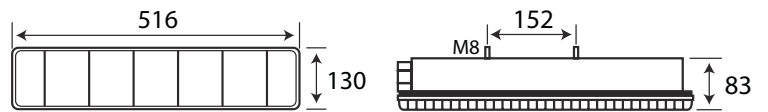

Zusätzl. Leuchtenfunktionen add. lighting functions	Steckerposition Steckerposition	Anschlussart connection type	OE- Nr. OE- No.	Steckerbelegung pin assignment	Anbauseite installation side	Art.-Nr. Part No.
Kennzeichenlicht licence plate light		Kabeldurchführung wire bushing	1436 867		◀ L	098 213 161
		Kabeldurchführung wire bushing	1436 868		▶ R	098 213 171
	seitlich lateral	AMP 1.5	1498 103		▶ R	098 213 162
Kennzeichenlicht licence plate light	seitlich lateral	AMP 1.5	1498 102		◀ L	098 213 163
		AMP 1.5	1792 374		▶ R	098 213 167
Kennzeichenlicht licence plate light	seitlich lateral	AMP 1.5	1792 375		◀ L	098 213 168

Zusatzartikel

Produktart product type	Artikeltitel article title	OE- Nr. OE- No.	Anschlussart connection type	Art.-Nr. Part No.
Lichtscheiben lens	Lichtscheibe lens	1380 819		098 293 163
		152 4795		
		8383237		
Stecker connector	KIT Scania 10mm		AMP 1.5 180°	099 111 481

Ⓔ



▪ Scania 3,4,P/G/R/T
 Mehrkammerleuchte

▪ Scania 3,4,P/G/R/T
 multi-chamber lights

Leuchtenfunktionen	lighting functions
Blinklicht	indicator
Bremslicht	stoplight
Schlusslicht	tail light
Schlusslicht 2	2. tail light
Rückfahrlicht	reverse light
Nebelschlusslicht	fog tail light
Positionslicht	position light
Seitenmarkierungslicht	side marker light
Rückstrahler	reflector

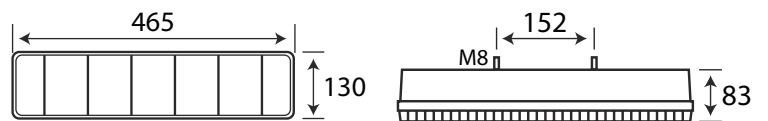

Zusätzl. Leuchtenfunktionen add. lighting functions	Anschlussart connection type	OE- Nr. OE- No.	Anbauseite installation side	Art.-Nr. Part No.
Kennzeichenlicht licence plate light	Kabeldurchführung wire bushing	1365 963	◀ L	098 212 963
		1386 272		
	Kabeldurchführung wire bushing	1365 964	▶ R	098 212 964
		1336 271		

Zusatzartikel

Produktart product type	Artikeltitel article title	OE- Nr. OE- No.	Art.-Nr. Part No.
Lichtscheiben lens	Lichtscheibe lens	127 26 53	098 292 793
		135 03 43	
		152 51 77	
		500 184 7588	
		81.25229-6051	
		81.25229-6052	
Lichtscheiben lens	Lichtscheibe für Rückstrahler und Seitenmarkierungs- leuchte lens for reflex reflector and side marker lamp	81.25229-6055	098 292 959
		8142919	
		931 61 844	



Ⓔ



▪ Scania 3,4,P/G/R/T
Mehrkammerleuchte

▪ Scania 3,4,P/G/R/T
multi-chamber lights

Leuchtenfunktionen

- Bremslicht
- Blinklicht
- Schlusslicht
- Schlusslicht 2
- Rückfahrlicht
- Seitenmarkierungslicht
- Rückstrahler

lighting functions

- stoplight
- indicator
- tail light
- 2. tail light
- reverse light
- side marker light
- reflector

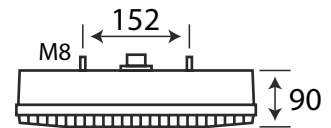
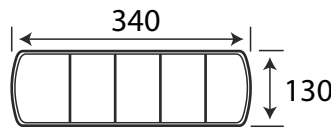

Zusätzl. Leuchtenfunktionen add. lighting functions	Anschlussart connection type	OE- Nr. OE- No.	Anbauseite installation side	Art.-Nr. Part No.
	Kabeldurchführung wire bushing	1409 253		098 213 220
Nebelschlusslicht fog tail light	Kabeldurchführung wire bushing	1409 252	◀	098 213 230

Zusatzartikel

Produktart product type	Artikeltitel article title	OE- Nr. OE- No.	Art.-Nr. Part No.
Lichtscheiben lens	Lichtscheibe lens	1412392	098 293 223



▪ Scania P/G/R 2008>
Mehrkammerleuchte

Leuchtenfunktionen

- Blinklicht
- Bremslicht
- Schlusslicht
- Schlusslicht 2
- Rückfahrlicht
- Nebelschlusslicht
- Seitenmarkierungslicht
- Rückstrahler

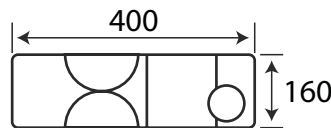

▪ Scania P/G/R 2008>
multi-chamber lights

lighting functions

- indicator
- stoplight
- tail light
- 2. tail light
- reverse light
- fog tail light
- side marker light
- reflector

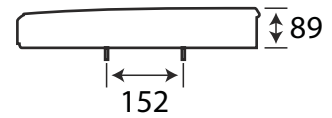

Zusätzl. Leuchtenfunktionen <i>add. lighting functions</i>	Steckerposition <i>connector position</i>	Anschlussart <i>connection type</i>	OE- Nr. <i>OE- No.</i>	Steckerbelegung <i>pin assignment</i>	Anbauseite <i>installation side</i>	Art.-Nr. <i>Part No.</i>
	seitlich lateral	AMP 1.5	175 6754 202 1579			098 212 895
	seitlich lateral	AMP 1.5	175 6751 202 1575			098 212 896
Rückfahrwarner back-up warning	seitlich lateral	AMP 1.5	179 1369 202 1576			098 212 897

Zusatzartikel

Produktart <i>product type</i>	Artikeltitel <i>article title</i>	OE- Nr. <i>OE- No.</i>	Anbauseite <i>installation side</i>	Anschlussart <i>connection type</i>	Art.-Nr. <i>Part No.</i>
Stecker connector	KIT MAN TG-A NW 8,5 gerade			AMP 1.5 180°	099 111 648
Lichtscheiben lens	Lichtscheibe lens	906 826 2056 1784 669			098 292 896
Lichtscheiben lens	Lichtscheibe lens	906 826 2156 1784 670			098 292 897



▪ Scania P/G/R 2008>
Mehrkammerleuchte

▪ Scania P/G/R 2008>
multi-chamber lights

Leuchtenfunktionen

- Blinklicht
- Bremslicht
- Schlusslicht
- Schlusslicht 2
- Rückfahrlicht
- Nebelschlusslicht
- Seitenmarkierungslicht
- Rückstrahler

lighting functions

- indicator
- stoplight
- tail light
- 2. tail light
- reverse light
- fog tail light
- side marker light
- reflector

Zusätzl. Leuchtenfunktionen <i>add. lighting functions</i>	Steckerposition <i>connector position</i>	Anschlussart <i>connection type</i>	Steckerbelegung <i>pin assignment</i>	Leuchtmittel <i>illuminant</i>	Anbauseite <i>installation side</i>	Art.-Nr. <i>Part No.</i>
Kennzeichenlicht <i>licence plate light</i>	seitlich <i>lateral</i>	AMP 1.5		LED	◀ L	098 215 900
	seitlich <i>lateral</i>	AMP 1.5		LED	▶ R	098 215 901

Zusatzartikel

Produktart <i>product type</i>	Artikeltitel <i>article title</i>	Anbauseite <i>installation side</i>	Anschlussart <i>connection type</i>	Art.-Nr. <i>Part No.</i>
Lichtscheiben <i>lens</i>	Lichtscheibe <i>lens</i>	◀ L		098 292 900
	Vorschaltgerät <i>converter</i>			098 400 020
Stecker <i>connector</i>	KIT MAN TG-A NW 8,5 <i>gerade</i>		AMP 1.5 180°	099 111 648
Lichtscheiben <i>lens</i>	Lichtscheibe <i>lens</i>	▶ R		098 292 901

Ⓔ



▪ Volvo F/FL/FS>9/98
 Mehrkammerleuchte

▪ Volvo FH/FL/FM/FS
 multi-chamber lights



Leuchtenfunktionen

- Blinklicht
- Bremslicht
- Schlusslicht
- Schlusslicht 2
- Rückfahrlicht
- Nebelschlusslicht

lighting functions

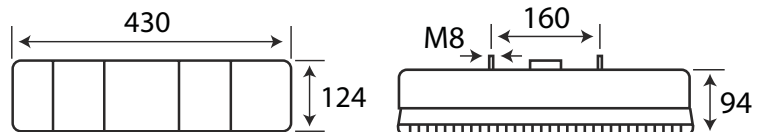
- indicator
- stoplight
- tail light
- 2. tail light
- reverse light
- fog tail light



Zusätzl. Leuchtenfunktionen add. lighting functions	OE- Nr. OE- No.	Steckerbelegung pin assignment	Anbauseite installation side	Art.-Nr. Part No.
Kennzeichenlicht licence plate light	2SK 005 883-011 2SK 005 883-031		L	098 212 711
	2SK 005 883-021		R	098 212 721

Zusatzartikel

Produktart product type	Artikeltitel article title	OE- Nr. OE- No.	Art.-Nr. Part No.
Lichtscheiben lens	Lichtscheibe lens	QEL 135 548-001	098 292 715

BEACHTEN SIE UNSERE
 LAUFENDEN AKTIONEN
 IN UNSEREN FILIALEN
 UND AUF
WWW.RAL.AT





Ⓔ



▪ **Volvo F/FL/FH >8/93-7/98**
Mehrkammerleuchte

▪ **Volvo FH/FL/FM/FS**
multi-chamber lights

Leuchtenfunktionen	lighting functions
Blinklicht	indicator
Bremslicht	stoplight
Schlusslicht	tail light
Schlusslicht 2	2. tail light
Rückfahrlicht	reverse light
Nebelschlusslicht	fog tail light
Positionslicht	position light
Seitenmarkierungslicht	side marker light
Rückstrahler	reflector

Zusätzl. Leuchtenfunktionen add. lighting functions	Anschlussart connection type	OE- Nr. OE- No.	Steckerbelegung pin assignment	Anbauseite installation side	Art.-Nr. Part No.
Kennzeichenlicht licence plate light	Stecker 8-polig System "Volvo" 8-pole connector system "Volvo"	819 1747		◀ L	098 214 465
	Stecker 8-polig System "Volvo" 8-pole connector system "Volvo"	819 1748		▶ R	098 214 475

Zusatzartikel

Produktart product type	Artikeltitel article title	OE- Nr. OE- No.	Art.-Nr. Part No.
Lichtscheiben lens	Lichtscheibe lens	127 26 53 135 03 43 152 51 77 500 184 7588 81.25229-6051 81.25229-6052 81.25229-6055 8142919 931 61 844	098 292 793
Lichtscheiben lens	Lichtscheibe für Rückstrahler und Seitenmarkierungsleuchte lens for reflex reflector and side marker lamp		098 292 959

Ⓔ





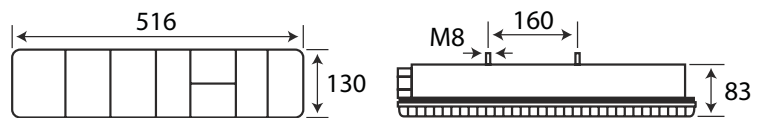

▪ **Volvo FL/FM/FH 8/93>**
Mehrkammerleuchte

▪ **Volvo FH/FL/FM/FS**
multi-chamber lights

Leuchtenfunktionen	lighting functions
Blinklicht	indicator
Bremslicht	stoplight
Schlusslicht	tail light
Schlusslicht 2	2. tail light
Rückfahrlicht	reverse light
Nebelschlusslicht	fog tail light
Positionslicht	position light
Seitenmarkierungslicht	side marker light
Rückstrahler	reflector



Zusätzl. Leuchtenfunktionen add. lighting functions	Steckerposition connector position	Anschlussart connection type	OE- Nr. OE- No.	Steckerbelegung pin assignment	Anbauseite installation side	Art.-Nr. Part No.
Kennzeichenlicht licence plate light	seitlich lateral	Stecker 6-polig 6-pole connector	398 1455			098 213 141
	seitlich lateral	Stecker 6-polig 6-pole connector	398 1456			098 213 151

Zusatzartikel

Produktart product type	Artikeltitel article title	OE- Nr. OE- No.	Anschlussart connection type	Art.-Nr. Part No.
Stecker connector	KIT NW 10 Renault, Volvo, DAF LF		AMP 1.5 90°	099 111 493
Lichtscheiben lens	Lichtscheibe lens	1380 819 152 4795 8383237		098 293 163



(E)



▪ Volvo FL, FM 01 > Mehrkammerleuchte

▪ Volvo FL, FM 01 > multi-chamber lights

Leuchtenfunktionen	lighting functions
Blinklicht	indicator
Bremslicht	stoplight
Schlusslicht	tail light
Schlusslicht 2	2. tail light
Rückfahrlicht	reverse light
Nebelschlusslicht	fog tail light
Positionslicht	position light
Seitenmarkierungslicht	side marker light
Rückstrahler	reflector

Zusätzl. Leuchtenfunktionen add. lighting functions	Steckerposition connector position	Anschlussart connection type	OE- Nr. OE- No.	Steckerbelegung pin assignment	Anbauseite installation side	Art.-Nr. Part No.
	seitlich lateral	Stecker 7-polig 7-pole connector	2042 5727 2050 7622		◀ L	098 214 440
	seitlich lateral	Stecker 7-polig 7-pole connector	2042 5729 2050 7624		▶ R	198 214 445
Kennzeichenlicht licence plate light	seitlich lateral	Stecker 7-polig 7-pole connector	2042 5728 2050 7623		◀ L	198 214 450
Rückfahrwarner back-up warning	seitlich lateral	Stecker 7-polig 7-pole connector	2051 3087		▶ R	198 214 455

Zusatzartikel

Produktart product type	Artikeltitel article title	OE- Nr. OE- No.	Anschlussart connection type	Art.-Nr. Part No.
Stecker connector	KIT NW 10 Renault, Volvo, DAF LF		AMP 1.5 90°	099 111 493
	Lichtscheibe	20425732		198 294 442

Ⓔ



▪ Volvo FH 2005 >
Mehrkammerleuchte

▪ Volvo FH 2005 >
multi-chamber lights

Leuchtenfunktionen	lighting functions
Blinklicht	indicator
Bremslicht	stoplight
Schlusslicht	tail light
Schlusslicht 2	2. tail light
Rückfahrlicht	reverse light
Nebelschlusslicht	fog tail light
Positionslicht	position light
Seitenmarkierungslicht	side marker light
Rückstrahler	reflector

Zusätzl. Leuchtenfunktionen add. lighting functions	Steckerposition connector position	Anschlussart connection type	OE- Nr. OE- No.	Steckerbelegung pin assignment	Anbauseite installation side	Art.-Nr. Part No.
	seitlich lateral	Stecker 7-polig 7-pole connector	2056 5106		R	198 214 510
	seitlich lateral	Stecker 7-polig 7-pole connector	2056 5105		L	198 214 515
Kennzeichenlicht licence plate light	seitlich lateral	Stecker 7-polig 7-pole connector	2056 5103		L	198 214 520

Zusatzartikel

Produktart product type	Artikeltitel article title	OE- Nr. OE- No.	Anschlussart connection type	Art.-Nr. Part No.
Stecker connector	KIT NW 10 Renault, Volvo, DAF LF		AMP 1.5 90°	099 111 493
	Lichtscheibe lens	20565107		198 294 523



▪ Volvo FL II, FE II 06 >
Mehrkammerleuchte

▪ Volvo FL II, FE II 06 >
multi-chamber lights

Leuchtenfunktionen

- Blinklicht
- Bremslicht
- Schlusslicht
- Schlusslicht 2
- Rückfahrlicht
- Nebelschlusslicht
- Rückstrahler

lighting functions

- indicator
- stoplight
- tail light
- 2. tail light
- reverse light
- fog tail light
- reflector

Zusätzl. Leuchtenfunktionen add. lighting functions	Anschlussart connection type	OE- Nr. OE- No.	Steckerbelegung pin assignment	Anbauseite installation side	Art.-Nr. Part No.
Kennzeichenlicht licence plate light	AMP 1.5	20769783 140 1713			098 212 910
	AMP 1.5	20769784 140 1731			098 212 912

BESUCHEN SIE
UNSERE HOMEPAGE
WWW.RAL.AT





▪ Volvo FL II, FE II 06 >
 Mehrkammerleuchte

▪ Volvo FL II, FE II 06 >
 multi-chamber lights

Leuchtenfunktionen

Blinklicht
 Bremslicht
 Schlusslicht
 Schlusslicht 2
 Seitenmarkierungslicht
 Rückstrahler

lighting functions

indicator
 stoplight
 tail light
 2. tail light
 side marker light
 reflector

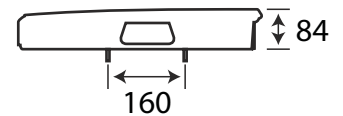
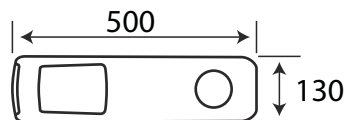

Zusätzl. Leuchtenfunktionen <i>add. lighting functions</i>	Steckerposition <i>connector position</i>	Anschlussart <i>connection type</i>	OE- Nr. <i>OE- No.</i>	Steckerbelegung <i>pin assignment</i>	Anbauseite <i>installation side</i>	Art.-Nr. <i>Part No.</i>
Nebelschlusslicht fog tail light	seitlich lateral	AMP 1.5	742 080 2348 20802346		◀ L	098 212 900
Nebelschlusslicht Kennzeichenlicht fog tail light licence plate light	seitlich lateral	AMP 1.5	742 080 2350 20802350		▶ R	098 212 901
Rückfahrlicht Rückfahrwarner reverse light back-up warning	seitlich lateral	AMP 1.5	742 080 2353 20802353		▶ R	098 212 902

Zusatzartikel

Produktart <i>product type</i>	Artikeltitel <i>article title</i>	OE- Nr. <i>OE- No.</i>	Anschlussart <i>connection type</i>	Art.-Nr. <i>Part No.</i>
Lichtscheiben lens	Lichtscheibe lens	20802418 742 080 2418		098 292 903
Stecker connector	KIT NW 10 Renault, Volvo, DAF LF		AMP 1.5 180°	099 110 619
Stecker connector	KIT NW 10 Renault, Volvo, DAF LF		AMP 1.5 90°	099 111 493



▪ Volvo LED FH&FH16 12/2012 > Mehrkammerleuchte

Auch passend zur Umrüstung der Modelle ab 2003 bis 11/2012
Wartungsfrei und langlebig

▪ Volvo LED FH&FH16 12/2012 > multi-chamber lights

Also useable to upgrade the models from 2003 up to 11/2012
Maintenance free and long lasting

Leuchtenfunktionen

- Blinklicht
- Bremslicht
- Schlusslicht
- Begrenzungslicht
- Nebelschlusslicht
- Rückfahrlicht
- Rückstrahler

lighting functions

- indicator
- stoplight
- tail light
- marker light
- fog tail light
- reverse light
- reflector

Zusätzl. Leuchtenfunktionen add. lighting functions	Anschlussspannung connection voltage	Anschlussart connection type	OE- Nr. OE- No.	Leuchtmittel illuminant	Anbauseite installation side	Art.-Nr. Part No.
Kennzeichenlicht licence plate light	12/24 V	AMP 1.5	82849894	LED	◀ L	098 214 560
	12/24 V	AMP 1.5	82849923	LED	▶ R	098 214 570
Rückfahrwarner back-up warning	12/24 V	AMP 1.5	82849925	LED	▶ R	098 214 580

Zusatzartikel

Produktart product type	Artikeltitel article title	Art.-Nr. Part No.
Lichtscheiben lens	Lichtscheibe lens	098 294 580

Ⓔ



▪ **Volvo**
Mehrkammerleuchte









▪ **Volvo**
multi-chamber lights

Leuchtenfunktionen

Blinklicht
 Bremslicht
 Schlusslicht
 Begrenzungslicht
 Nebelschlusslicht
 Rückfahrlicht
 Rückstrahler

lighting functions

indicator
 stoplight
 tail light
 marker light
 fog tail light
 reverse light
 reflector

Zusätzl. Leuchtenfunktionen <i>add. lighting functions</i>	Steckerposition <i>connector position</i>	Anschlussspannung <i>connection voltage</i>	Anschlussart <i>connection type</i>	OE- Nr. <i>OE- No.</i>	Steckerbelegung <i>pin assignment</i>	Leuchtmittel <i>illuminant</i>	Anbauseite <i>installation side</i>	Art.-Nr. <i>Part No.</i>
Kennzeichenlicht <i>licence plate light</i>	seitlich <i>lateral</i>	24 V	AMP 1.5	824830 74		LED		098 214 530
	seitlich <i>lateral</i>	24 V	AMP 1.5	217353 01		LED		098 214 540
Rückfahrwarner <i>back-up warning</i>	seitlich <i>lateral</i>	24 V	AMP 1.5	824830 73		LED		098 214 535
	seitlich <i>lateral</i>	24 V	AMP 1.5	217352 99		LED		098 214 545



▪ MB Sprinter, VW Crafter 04/
2006 >
Mehrkammerleuchte

▪ MB Sprinter, VW Crafter 04/
2006 >
multi-chamber lights

Leuchtenfunktionen

- Blinklicht
- Bremslicht
- Schlusslicht
- Nebelschlusslicht
- Rückfahrlicht
- Seitenmarkierungslicht
- Begrenzungslicht
- Rückstrahler

lighting functions

- indicator
- stoplight
- tail light
- fog tail light
- reverse light
- side marker light
- marker light
- reflector

160 ± 1,5

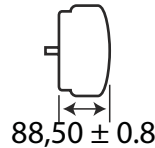
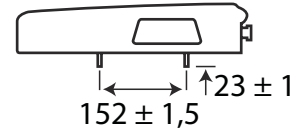
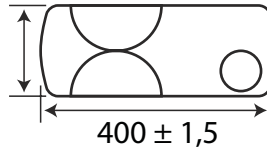

Zusätzl. Leuchtenfunktionen <i>add. lighting functions</i>	Anschlussart <i>connection type</i>	OE- Nr. <i>OE- No.</i>	Anbauseite <i>installation side</i>	Art.-Nr. <i>Part No.</i>
Kennzeichenlicht licence plate light	AMP 1.5	906 820 0464	◀ L	098 212 893
	AMP 1.5	906 820 1764	▶ R	098 212 894

Zusatzartikel

Produktart <i>product type</i>	Artikeltitel <i>article title</i>	OE- Nr. <i>OE- No.</i>	Anbauseite <i>installation side</i>	Anschlussart <i>connection type</i>	Art.-Nr. <i>Part No.</i>
Lichtscheiben lens	Lichtscheibe lens	906 826 2056 1784 669	◀ L		098 292 896
Lichtscheiben lens	Lichtscheibe lens	906 826 2156 1784 670	▶ R		098 292 897
Stecker connector	KIT Diameter Kabel 5mm MB Sprinter, VW Crafter KIT diameter cable 5mm MB Sprinter, VW Crafter			AMP 1.5 90°	099 111 485



▪ MK, SK > 10/94
Mehrkammerleuchte

▪ MK, SK > 10/94
multi-chamber lights

Leuchtenfunktionen

Blinklicht
 Bremslicht
 Schlusslicht
 Schlusslicht 2
 Rückfahrlicht
 Positionslicht
 Seitenmarkierungslicht
 Rückstrahler

lighting functions

indicator
 stoplight
 tail light
 2. tail light
 reverse light
 position light
 side marker light
 reflector

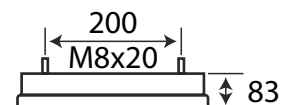
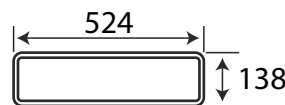

Zusätzl. Leuchtenfunktionen <i>add. lighting functions</i>	Anschlussart <i>connection type</i>	OE- Nr. <i>OE- No.</i>	Steckerbelegung <i>pin assignment</i>	Anbauseite <i>installation side</i>	Art.-Nr. <i>Part No.</i>
Kennzeichenlicht licence plate light	AMP 1.5	001 540 1770		◀ L	098 213 341
	AMP 1.5	001 540 1870		▶ R	098 213 351

Zusatzartikel

Produktart <i>product type</i>	Artikeltitel <i>article title</i>	OE- Nr. <i>OE- No.</i>	Anbauseite <i>installation side</i>	Art.-Nr. <i>Part No.</i>
Lichtscheiben lens	Lichtscheibe lens	002 544 1290 002 544 3690	◀ L	098 293 323
Lichtscheiben lens	Lichtscheibe lens	002 544 1390 002 544 1690	▶ R	098 293 333



(E)



▪ **MB Mehrkammerleuchte**

▪ **MB multi-chamber lights**

Leuchtenfunktionen

Blinklicht
Bremslicht
Schlusslicht
Rückstrahler

lighting functions

indicator
stoplight
tail light
reflector

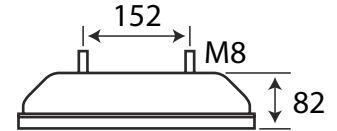
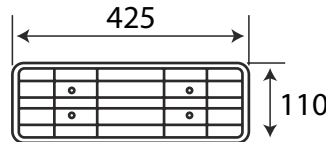

Zusätzl. Leuchtenfunktionen <i>add. lighting functions</i>	Anschlussart <i>connection type</i>	OE- Nr. <i>OE- No.</i>	Anbauseite <i>installation side</i>	Art.-Nr. <i>Part No.</i>
Nebelschlusslicht Kennzeichenlicht fog tail light licence plate light	PG Verschraubung screw connection PG	2VB 004 887-011 002 544 0703	◀ L	098 213 511
Nebelschlusslicht fog tail light	PG Verschraubung screw connection PG	2VA 004 887-031 002 544 0903	◀ L	098 213 516
Rückfahrlicht reverse light	PG Verschraubung screw connection PG	2VP 004 887-021 002 544 0803	▶ R	098 213 521

Zusatzartikel

Produktart <i>product type</i>	Artikeltitel <i>article title</i>	OE- Nr. <i>OE- No.</i>	Anbauseite <i>installation side</i>	Anschlussart <i>connection type</i>	Art.-Nr. <i>Part No.</i>
Stecker connector	KIT MB Atego, F2000, DAF			AMP 1.5 90°	099 110 629
Lichtscheiben lens	Lichtscheibe lens	002 544 0690	◀ L		098 293 513
Lichtscheiben lens	Lichtscheibe lens	002 544 0790	▶ R		098 293 523

(E)



▪ **MB Evobus Neoman Mehrkammerleuchte**

▪ **MB Evobus Neoman multi-chamber lights**

Leuchtenfunktionen

Bremslicht
Schlusslicht

lighting functions

stoplight
tail light

Sockelausführung <i>socket version</i>	Anschlussleistung <i>connected load</i>	Anschlussspannung <i>connection voltage</i>	Anschlussart <i>connection type</i>	Kabellänge <i>cable length</i>	Leuchtmittel <i>illuminant</i>	Art.-Nr. <i>Part No.</i>
BAY15d	21/5 W	24 V	Kabel wire	200 mm		098 203 049
		24 V	Kabel wire	200 mm	LED	098 203 059



▪ **MB Sprinter 2003 > Mehrkammerleuchte**





▪ **MB Sprinter 2003 > multi-chamber lights**

Leuchtenfunktionen

Blinklicht
 Bremslicht
 Schlusslicht
 Rückfahrlicht
 Nebelschlusslicht

lighting functions

indicator
 stoplight
 tail light
 reverse light
 fog tail light

Anschlussart connection type	OE- Nr. OE- No.	Steckerbelegung pin assignment	Anbauseite installation side	Art.-Nr. Part No.
Flachstecker 6,3mm flat connector 6.3mm	000 826 1556		◀ L	098 213 041
Flachstecker 6,3mm flat connector 6.3mm	000 826 1656		▶ R	098 213 042
Flachstecker 6,3mm flat connector 6.3mm			◀ L	098 213 043
Flachstecker 6,3mm flat connector 6.3mm			▶ R	098 213 044



Ⓔ



▪ **MB Sprinter
Mehrkammerleuchte**

▪ **MB Sprinter
multi-chamber lights**

Leuchtenfunktionen

- Blinklicht
- Blinklicht
- Schlusslicht
- Schlusslicht 2
- Rückfahrlicht
- Nebelschlusslicht
- Positionslicht
- Seitenmarkierungslicht
- Rückstrahler Dreieck

lighting functions

- indicator
- indicator
- tail light
- 2. tail light
- reverse light
- fog tail light
- position light
- side marker light
- reflector triangular

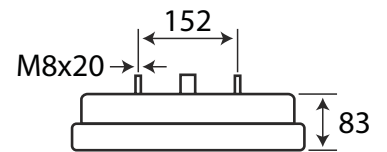
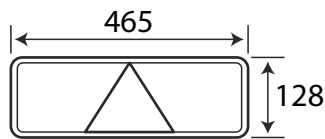

Anschlussart connection type	Anbauseite installation side	Art.-Nr. Part No.
PG Verschraubung screw connection PG	R	098 213 610
PG Verschraubung screw connection PG	L	098 213 612

Zusatzartikel

Produktart product type	Artikeltitel article title	Anbauseite installation side	Art.-Nr. Part No.
Lichtscheiben lens	Lichtscheibe lens	R	098 293 611
Lichtscheiben lens	Lichtscheibe lens	L	098 293 613



▪ **Atego, Actros
 Mehrkammerleuchte**

▪ **Atego, Actros
 multi-chamber lights**

Leuchtenfunktionen	lighting functions
Blinklicht	indicator
Bremslicht	stoplight
Schlusslicht	tail light
Schlusslicht 2	2. tail light
Rückfahrlicht	reverse light
Nebelschlusslicht	fog tail light
Positionslicht	position light
Seitenmarkierungslicht	side marker light
Rückstrahler	reflector



Zusätzl. Leuchtenfunktionen add. lighting functions	Steckerposition connector position	Anschlussart connection type	OE- Nr. OE- No.	Steckerbelegung pin assignment	Anbauseite installation side	Art.-Nr. Part No.
Kennzeichenlicht licence plate light	seitlich lateral	AMP 1.5	001 540 6270		◀ L	098 213 346
	seitlich lateral	AMP 1.5	001 540 6370		▶ R	098 213 356
Kennzeichenlicht licence plate light	seitlich lateral	AMP 1.5	001 540 6270		◀ L	098 213 366

Zusatzartikel

Produktart product type	Artikeltitel article title	OE- Nr. OE- No.	Anbauseite installation side	Anschlussart connection type	Art.-Nr. Part No.
Stecker connector	KIT NW 10 Renault, Volvo, DAF LF			AMP 1.5 90°	099 111 493
Lichtscheiben lens	Lichtscheibe lens	002 544 1290 002 544 3690	◀ L		098 293 323
Lichtscheiben lens	Lichtscheibe lens	002 544 1390 002 544 1690	▶ R		098 293 333



(E)



▪ **MB Atego, Axor, Actros Mehrkammerleuchte**

▪ **MB Atego, Axor, Actros multi-chamber lights**

Leuchtenfunktionen	lighting functions
Blinklicht	indicator
Bremslicht	stoplight
Schlusslicht	tail light
Nebelschlusslicht	fog tail light
Rückfahrlicht	reverse light
Seitenmarkierungslicht	side marker light

Zusätzl. Leuchtenfunktionen add. lighting functions	Steckerposition connector position	Anschlussspannung connection voltage	Anschlussart connection type	Leuchtmittel illuminant	Anbauseite installation side	Art.-Nr. Part No.
Kennzeichenlicht licence plate light	seitlich lateral	24 V	Stecker 6-polig 6-pole connector	LED	◀ L	098 215 381
	seitlich lateral	24 V	Stecker 6-polig 6-pole connector	LED	▶ R	098 215 391

(E)



▪ **Sprinter Mehrkammerleuchte**

▪ **Sprinter multi-chamber lights**

Leuchtenfunktionen	lighting functions
Blinklicht	indicator
Bremslicht	stoplight
Schlusslicht	tail light
Schlusslicht 2	2. tail light
Rückfahrlicht	reverse light
Nebelschlusslicht	fog tail light
Positionslicht	position light
Seitenmarkierungslicht	side marker light
Rückstrahler	reflector

Zusätzl. Leuchtenfunktionen add. lighting functions	Anschlussart connection type	OE- Nr. OE- No.	Steckerbelegung pin assignment	Anbauseite installation side	Art.-Nr. Part No.
Kennzeichenlicht licence plate light	AMP 1.5	002 544 5503		◀ L	098 213 361
	AMP 1.5	002 544 5403		▶ R	098 213 371

Zusatzartikel

Produktart product type	Artikeltitel article title	OE- Nr. OE- No.	Anschlussart connection type	Art.-Nr. Part No.
Stecker connector	KIT NW 10 Renault, Volvo, DAF LF		AMP 1.5 90°	099 111 493
Lichtscheiben lens	Lichtscheibe lens	002 544 4790		098 293 363

Ⓔ



▪ **MB Actros MP4
 Mehrkammerleuchte**

▪ **MB Actros MP4
 multi-chamber lights**

Leuchtenfunktionen	lighting functions
Blinklicht	indicator
Bremslicht	stoplight
Schlusslicht	tail light
Rückfahrlicht	reverse light
Nebelschlusslicht	fog tail light
Rückstrahler	reflector
Begrenzungslicht	marker light

Zusätzl. Leuchtenfunktionen add. lighting functions	Steckerposition connector position	Anschlussspannung connection voltage	Anschlussart connection type	OE- Nr. OE- No.	Anbauseite installation side	Art.-Nr. Part No.
Kennzeichenlicht licence plate light	seitlich lateral	24 V	Stecker HDS CS seitlich connector HDS CS lateral	003 544 0903 003 544 1703	◀ L	098 213 400
	seitlich lateral	24 V	Stecker HDS CS seitlich connector HDS CS lateral	003 544 0803 003 544 1603	▶ R	098 213 405
Rückfahrwarner back-up warning	seitlich lateral	24 V	Stecker HDS CS seitlich connector HDS CS lateral	003 544 1003 003 544 1803	▶ R	098 213 410

Zusatzartikel

Produktart product type	Artikeltitel article title	OE- Nr. OE- No.	Art.-Nr. Part No.
Lichtscheiben lens	Lichtscheibe lens	002 544 7390	098 293 400
Stecker connector	Anschlusssatz HDSCS MB 90° conter connector kit HDSCS MB 90°		099 110 151



▪ **MB Atego**
Mehrkammerleuchte

Lampenträger mit Schwingungsdämpfer
2 Glühlampenfassungen im
Schlußlichtbereich

▪ **MB Atego**
multi-chamber lights

*Bulb holder anti-vibration
2 bulb sockets in the tail light area*

Leuchtenfunktionen	lighting functions
Blinklicht	indicator
Bremslicht	stoplight
Schlusslicht	tail light
Rückfahrlicht	reverse light
Nebelschlusslicht	fog tail light
Positionslicht	position light
Seitenmarkierungslicht	side marker light
Rückstrahler	reflector
Begrenzungslicht	marker light



Zusätzl. Leuchtenfunktionen add. lighting functions	OE- Nr. OE- No.	Steckerbelegung pin assignment	Anbauseite installation side	Art.-Nr. Part No.
Kennzeichenlicht licence plate light	003 544 5303			098 213 381
	003 544 5703			098 213 391

Zusatzartikel

Produktart product type	Artikeltitel article title	OE- Nr. OE- No.	Anschlussart connection type	Art.-Nr. Part No.
Stecker connector	KIT MB Atego, F2000, DAF		AMP 1.5 90°	099 110 629
Lichtscheiben lens	Lichtscheibe lens	002 544 4790		098 293 363

Ⓔ



▪ **MB Atego**
Mehrkammerleuchte

▪ **MB Atego**
multi-chamber lights



Leuchtenfunktionen

Blinklicht
Bremslicht
Schlusslicht
Schlusslicht 2
Rückfahrlicht
Nebelschlusslicht
Rückstrahler

lighting functions

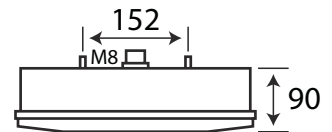
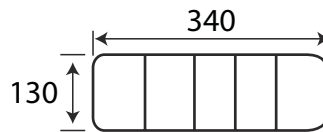
indicator
stoplight
tail light
2. tail light
reverse light
fog tail light
reflector



Zusätzl. Leuchtenfunktionen <i>add. lighting functions</i>	Anschlussart <i>connection type</i>	OE- Nr. <i>OE- No.</i>	Steckerbelegung <i>pin assignment</i>	Anbauseite <i>installation side</i>	Art.-Nr. <i>Part No.</i>
Kennzeichenlicht licence plate light	AMP 1.5	002 544 6803 002 544 7003		◀ L	098 213 180
	AMP 1.5	002 544 6903 002 544 7103		▶ R	098 213 190

Zusatzartikel

Produktart <i>product type</i>	Artikeltitel <i>article title</i>	OE- Nr. <i>OE- No.</i>	Anschlussart <i>connection type</i>	Art.-Nr. <i>Part No.</i>
Lichtscheiben lens	Lichtscheibe lens	002 544 6190 81.25225-6538		098 293 182
Stecker connector	KIT MB Atego, F2000, DAF		AMP 1.5 90°	099 110 629



▪ MB Sprinter 02/1995 >
Mehrkammerleuchte

▪ MB Sprinter 02/1995 >
multi-chamber lights

Leuchtenfunktionen

Blinklicht
Bremslicht
Schlusslicht
Rückfahrlicht
Nebelschlusslicht

lighting functions

indicator
stoplight
tail light
reverse light
fog tail light

Zusätzl. Leuchtenfunktionen add. lighting functions	Anschlussart connection type	OE- Nr. OE- No.	Steckerbelegung pin assignment	Anbauseite installation side	Art.-Nr. Part No.
Begrenzungslicht marker light	Flachstecker 6,3mm flat connector 6.3mm	901 820 0764		◀ L	098 213 031
	Flachstecker 6,3mm flat connector 6.3mm	901 820 1064		▶ R	098 213 032
	Flachstecker 6,3mm flat connector 6.3mm	000 826 0756		◀ L	098 213 035
	Flachstecker 6,3mm flat connector 6.3mm	000 826 0856		▶ R	098 213 036

(E)



▪ **Fiat Agri**
Mehrkammerleuchte

▪ **Fiat Agri**
multi-chamber lights

Leuchtenfunktionen

Blinklicht
 Bremslicht
 Schlusslicht

lighting functions

indicator
 stoplight
 tail light

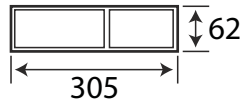

Zusätzl. Leuchtenfunktionen <i>add. lighting functions</i>	Sockelausführung <i>socket version</i>	Anschlussspannung <i>connection voltage</i>	Anschlussart <i>connection type</i>	Kabellänge <i>cable length</i>	Anbauseite <i>installation side</i>	Art.-Nr. <i>Part No.</i>
Kennzeichenlicht <i>licence plate light</i>	BA15s	12/24 V	Flachstecker 6,3mm <i>flat connector 6.3mm</i>	80 mm	◀ L	098 217 350
	BA15s	12/24 V	Flachstecker 6,3mm <i>flat connector 6.3mm</i>	80 mm	▶ R	098 217 351

Zusatzartikel

Produktart <i>product type</i>	Artikeltitel <i>article title</i>	Anbauseite <i>installation side</i>	Art.-Nr. <i>Part No.</i>
Lichtscheiben <i>lens</i>	Lichtscheibe <i>lens</i>	◀ L	098 297 352
Lichtscheiben <i>lens</i>	Lichtscheibe <i>lens</i>	▶ R	098 297 353

(E)



▪ **Steyr Case**
Mehrkammerleuchte

▪ **Steyr Case**
multi-chamber lights

Heckleuchte

multi-chamber lights

Leuchtenfunktionen

Blinklicht
 Bremslicht
 Schlusslicht
 Rückstrahler

lighting functions

indicator
 stoplight
 tail light
 reflector

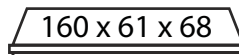

Sockelausführung <i>socket version</i>	Anschlussspannung <i>connection voltage</i>	Art.-Nr. <i>Part No.</i>
BA15s	12/24 V	910 212 240

Zusatzartikel

Artikeltitel <i>article title</i>	Art.-Nr. <i>Part No.</i>
Lichtscheibe <i>lens</i>	098 297 260



Ⓔ



▪ Massey Ferguson
Mehrkammerleuchte

▪ Massey Ferguson
multi-chamber lights

Leuchtenfunktionen

Blinklicht
Bremslicht
Schlusslicht
Rückstrahler

lighting functions

indicator
stoplight
tail light
reflector

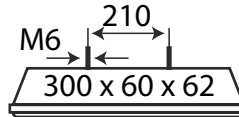

Sockelausführung socket version	Anschlussspannung connection voltage	OE- Nr. OE- No.	Art.-Nr. Part No.
BA15s BAY15d	12/24 V	2 VA 997 113-001	098 212 180

Ⓔ



▪ MAN, VW
Mehrkammerleuchte

▪ MAN, VW
multi-chamber lights

Leuchtenfunktionen

Blinklicht
Bremslicht
Schlusslicht
Schlusslicht 2
Rückfahrlicht
Nebelschlusslicht

lighting functions

indicator
stoplight
tail light
2. tail light
reverse light
fog tail light

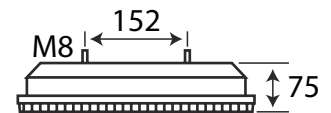
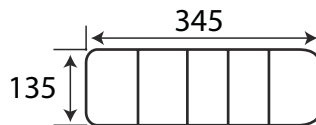

Zusätzl. Leuchtenfunktionen add. lighting functions	Anschlussart connection type	OE- Nr. OE- No.	Steckerbelegung pin assignment	Anbauseite installation side	Art.-Nr. Part No.
Kennzeichenlicht licence plate light	Kabeldurchführung wire bushing	2SL003 567 311		◀ L	098 212 731
	Kabeldurchführung wire bushing	2SK003 567-331		◀ L	098 212 736
	Kabeldurchführung wire bushing	2SK003 567-321		▶ R	098 212 741
Kennzeichenlicht Rückstrahler Nebelschlusslicht licence plate light reflector fog tail light	Kabeldurchführung wire bushing	2VP003 567-377		◀ L	098 212 751

▪ **MAN, VW**
Mehrkammerleuchte

▪ **MAN, VW**
multi-chamber lights

Zusätzl. Leuchtenfunktionen <i>add. lighting functions</i>	Anschlussart <i>connection type</i>	OE- Nr. <i>OE- No.</i>	Steckerbelegung <i>pin assignment</i>	Anbauseite <i>installation side</i>	Art.-Nr. <i>Part No.</i>
Rückstrahler Nebelschlusslicht reflector fog tail light	Kabeldurchführung wire bushing	2VP003 567-111		◀	098 212 756
Rückstrahler Nebelschlusslicht reflector fog tail light	Stecker 6-polig System "Schlemmer" 6-pole connector system "Schlemmer"			◀	098 212 758

Zusatzartikel

Produktart <i>product type</i>	Artikeltitel <i>article title</i>	OE- Nr. <i>OE- No.</i>	Anschlussart <i>connection type</i>	Zusätzl. Leuchtenfunktionen <i>add. lighting functions</i>	Art.-Nr. <i>Part No.</i>
Stecker connector	Stecker System SCHLEMMER		AMP 1.5 90°		098 292 775
Lichtscheiben lens		QEL 122 689-021 81.25229-6040		Rückstrahler reflector	098 292 753

**ALLE ARTIKEL FINDEN
 SIE AUCH IN UNSEREM
 WEBSHOP**





(E)



▪ DAF Iveco, Renault, MAN, Scania, Volvo
Mehrkammerleuchte

▪ DAF Iveco, Renault, MAN, Scania, Volvo
multi-chamber lights

Leuchtenfunktionen	lighting functions
Blinklicht	indicator
Bremslicht	stoplight
Schlusslicht	tail light
Schlusslicht 2	2. tail light
Rückfahrlicht	reverse light
Nebelschlusslicht	fog tail light
Positionslicht	position light
Seitenmarkierungslicht	side marker light
Rückstrahler Dreieck	reflector triangular

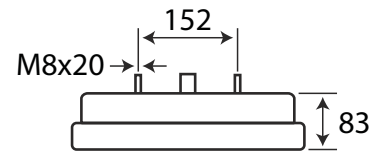
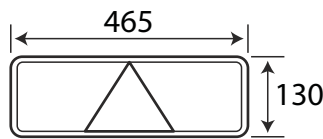

Zusätzl. Leuchtenfunktionen add. lighting functions	Anschlussart connection type	Anbauseite installation side	Art.-Nr. Part No.
Kennzeichenlicht licence plate light	PG Verschraubung screw connection PG	◀ L	098 212 972
	PG Verschraubung screw connection PG	▶ R	098 212 974

Zusatzartikel

Produktart product type	Artikeltitel article title	Anbauseite installation side	Art.-Nr. Part No.
Lichtscheiben lens	Lichtscheibe für Rückstrahler und Seitenmarkierungsleuchte lens for reflex reflector and side marker lamp		098 292 959
Lichtscheiben lens	Lichtscheibe lens	◀ L	098 292 973

(E)



▪ Neoplan, Scania Citybus, Volvo / Säffle Citybus
Mehrkammerleuchte

▪ Neoplan, Scania Citybus, Volvo / Säffle Citybus
multi-chamber lights

Leuchtenfunktionen	lighting functions
Bremslicht	stoplight
Schlusslicht	tail light

Sockelausführung socket version	Anschlussleistung connected load	Anschlussspannung connection voltage	Anschlussart connection type	OE- Nr. OE- No.	Art.-Nr. Part No.
BAY15d	21/5 W	12/24 V	Flachstecker 6,3mm flat connector 6.3mm	2SB 005 603-137	098 203 039



▪ **Nissan, Renault Trucks
 Mehrkammerleuchte**

▪ **Nissan, Renault Trucks
 multi-chamber lights**

Leuchtenfunktionen	lighting functions
Blinklicht	indicator
Bremslicht	stoplight
Schlusslicht	tail light
Schlusslicht 2	2. tail light
Rückfahrlicht	reverse light
Nebelschlusslicht	fog tail light
Rückstrahler	reflector

Zusätzl. Leuchtenfunktionen add. lighting functions	Anschlussart connection type	OE- Nr. OE- No.	Steckerbelegung pin assignment	Anbauseite installation side	Art.-Nr. Part No.
	AMP 1.5	20769784 140 1731			098 212 912
Kennzeichenlicht licence plate light	AMP 1.5	20769783 140 1713			098 212 910

Zusatzartikel

Produktart product type	Artikeltitel article title	Anschlussart connection type	Art.-Nr. Part No.
Lichtscheiben lens			098 292 933
Stecker connector	KIT NW 10 Renault, Volvo, DAF LF	AMP 1.5 90°	099 111 493



▪ Iveco, Ford, Kässbohrer, MAN, Scania, Volvo
Mehrkammerleuchte

▪ Iveco, Ford, Kässbohrer, MAN, Scania, Volvo
multi-chamber lights

Leuchtenfunktionen

Blinklicht
Bremslicht
Schlusslicht
Schlusslicht 2

lighting functions

indicator
stoplight
tail light
2. tail light

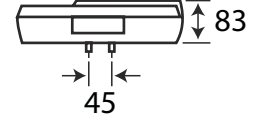
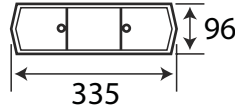

Zusätzl. Leuchtenfunktionen add. lighting functions	Sockelausführung socket version	Anschlussspannung connection voltage	OE- Nr. OE- No.	Anbauseite installation side	Art.-Nr. Part No.
Kennzeichenlicht licence plate light	BA15s	12/24 V	2SE 001 688-151	◀ L	098 212 220
	BA15s	12/24 V	2SD 001 688-141	▶ R	098 212 230

Zusatzartikel

Produktart product type	Artikeltitel article title	OE- Nr. OE- No.	Art.-Nr. Part No.
Lichtscheiben lens	Lichtscheibe lens	QEL 092 435-011	098 292 222



▪ Iveco Magirus, Kässbohrer, Kögl, MAN, MB, Steyr Mehrkammerleuchte

▪ Iveco Magirus, Kässbohrer, Kögl, MAN, MB, Steyr multi-chamber lights

Leuchtenfunktionen

Blinklicht
Bremslicht
Schlusslicht

lighting functions

indicator
stoplight
tail light

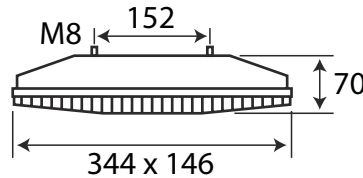

Zusätzl. Leuchtenfunktionen <i>add. lighting functions</i>	Sockelausführung <i>socket version</i>	Anschlussspannung <i>connection voltage</i>	Anschlussart <i>connection type</i>	OE- Nr. <i>OE- No.</i>	Anbauseite <i>installation side</i>	Art.-Nr. <i>Part No.</i>
Kennzeichenlicht <i>licence plate light</i>	BA15s	12/24 V	Kabeldurchführung <i>wire bushing</i>	2SE 003 167-031 001 544 69 03		098 212 561
	BA15s	12/24 V	Kabeldurchführung <i>wire bushing</i>	2SD 003 167-011 001 544 8103 2SD 003 167-021		098 212 571

Zusatzartikel

Produktart <i>product type</i>	Artikeltitel <i>article title</i>	Art.-Nr. <i>Part No.</i>
Lichtscheiben <i>lens</i>	Lichtscheibe <i>lens</i>	098 292 573



▪ Citroen, Fiat, Peugeot 1994 > Mehrkammerleuchte

▪ Citroen, Fiat, Peugeot 1994 > multi-chamber lights

Leuchtenfunktionen

Blinklicht
Bremslicht
Schlusslicht
Rückfahrlicht
Rückstrahler
Nebelschlusslicht

lighting functions

indicator
stoplight
tail light
reverse light
reflector
fog tail light

Anschlussart connection type	Steckerbelegung pin assignment	Anbauseite installation side	Art.-Nr. Part No.
AMP Superseal			098 213 010
AMP Superseal			098 213 020

(E)



- Iveco Magirus, MAN, Mercedes Benz Mehrkammerleuchte
- Iveco Magirus, MAN, Mercedes Benz multi-chamber lights

Leuchtenfunktionen	lighting functions
Blinklicht	indicator
Bremslicht	stoplight
Schlusslicht	tail light

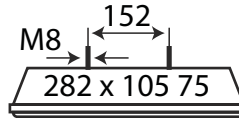

Zusätzl. Leuchtenfunktionen add. lighting functions	Sockelausführung socket version	Anschlussspannung connection voltage	OE- Nr. OE- No.	Anbauseite installation side	Art.-Nr. Part No.
Kennzeichenlicht licence plate light	BA15s	12/24 V	2SE 001 699-071	◀ L	098 212 451
	BA15s	12/24 V	2SD 001 699-061	▶ R	098 212 461

Zusatzartikel

Artikeltitle article title	OE- Nr. OE- No.	Art.-Nr. Part No.
Lichtscheibe lens	2SD 001 699-061	098 292 463

(E)



- ER-X GLOWCUBE V3 LED Mehrkammerleuchte
- ER-X GLOWCUBE V3 LED multi-chamber lights

Niedriger Energieverbrauch; komplett Staub- und Wasserdicht
Low power consumption; entirely dust- and watertight

Leuchtenfunktionen	lighting functions
Begrenzungslicht	marker light
Blinklicht	indicator
Bremslicht	stoplight

Zusätzl. Leuchtenfunktionen add. lighting functions	Leuchtmittel-farbe lamp colour	Anschlussspannung connection voltage	Anschlussart connection type	Kabel-länge cable length	Leucht-mittel illuminant	Betriebstempe-ratur temperature	Art.-Nr. Part No.
Kennzeichenlicht licence plate light	orange rot amber red	12-36 V		1000 mm	LED	-40 bis 80	098 212 176
Kennzeichenlicht licence plate light	orange rot amber red	12-36 V	Stecker 5-polig Bajonett 5-pin bayonet connector		LED	-40 bis 80	098 212 177



▪ **ER-X GLOWCUBE V3 LED Mehrkammerleuchte**

▪ **ER-X GLOWCUBE V3 LED multi-chamber lights**

Zusätzl. Leuchtenfunktionen <i>add. lighting functions</i>	Leuchtmittelfarbe <i>lamp colour</i>	Anschlussspannung <i>connection voltage</i>	Anschlussart <i>connection type</i>	Kabellänge <i>cable length</i>	Leuchtmittel <i>illuminant</i>	Betriebstemperatur <i>temperature</i>	Art.-Nr. <i>Part No.</i>
	orange rot amber red	12-36 V		1000 mm	LED	-40 bis 80	098 212 178
	orange rot amber red	12-36 V	Stecker 4-polig System "Aspöck" 4-pole connector system "Aspöck"		LED	-40 bis 80	098 212 179

Ⓔ



▪ **ER-X GLOWCUBE V3 LED Mehrkammerleuchte**

▪ **ER-X GLOWCUBE V3 LED multi-chamber lights**

Niedriger Energieverbrauch; komplett Staub- und Wasserdicht

Low power consumption; entirely air- and watertight

Leuchtenfunktionen

Begrenzungslicht
Blinklicht
Bremslicht

lighting functions

*marker light
indicator
stoplight*

Leuchtmittelfarbe <i>lamp colour</i>	Anschlussspannung <i>connection voltage</i>	Anschlussart <i>connection type</i>	Kabellänge <i>cable length</i>	Leuchtmittel <i>illuminant</i>	Betriebstemperatur <i>temperature</i>	Art.-Nr. <i>Part No.</i>
orange weiß rot amber white red	12-36 V		1000 mm	LED	-40 bis 80	098 212 174
orange weiß rot amber white red	12-36 V	Stecker 4-polig System "Aspöck" 4-pole connector system "Aspöck"		LED	-40 bis 80	098 212 175

Ⓔ



▪ **ER-X GLOWCUBE V1 LED Mehrkammerleuchte**

Niedriger Energieverbrauch; komplett Staub- und Wasserdicht

Leuchtenfunktionen

Begrenzungslicht
 Blinklicht
 Bremslicht

▪ **ER-X GLOWCUBE V1 LED multi-chamber lights**

Low power consumption; entirely dust- and watertight

lighting functions

*marker light
 indicator
 stoplight*

Leuchtmittelfarbe <i>lamp colour</i>	Anschlussspannung <i>connection voltage</i>	Anschlussart <i>connection type</i>	Kabellänge <i>cable length</i>	Leuchtmittel <i>illuminant</i>	Betriebstemperatur <i>temperature</i>	Art.-Nr. <i>Part No.</i>
weiß rot white red	12-36 V		1000 mm	LED	-40 bis 80	098 212 170
weiß rot white red	12-36 V	Stecker 4-polig System "Aspöck" 4-pole connector system "Aspöck"		LED	-40 bis 80	098 212 171
weiß rot white red	12-36 V		1000 mm	LED	-40 bis 80	098 212 172
weiß rot white red	12-36 V	Stecker 4-polig System "Aspöck" 4-pole connector system "Aspöck"		LED	-40 bis 80	098 212 173



Ⓔ



▪ **Universal Mehrkammerleuchte**

Alle Funktionen in LED; Nachrüsten eines Lastwiderstandes fahrzeugabhängig notwendig

▪ **universal multi-chamber lights**

all functions in LED technology; depending on the vehicle an retrofitting of a resistor is necessary

Leuchtenfunktionen

Begrenzungslicht
Blinklicht
Bremslicht
Kennzeichenlicht

lighting functions

*marker light
indicator
stoptlight
licence plate light*

Anschlussspannung <i>connection voltage</i>	Anschlussart <i>connection type</i>	Kabellänge <i>cable length</i>	Leuchtmittel <i>illuminant</i>	Art.-Nr. <i>Part No.</i>
12 V		200 mm	LED	098 212 150
12 V	Stecker 5-polig Bajonett 5-pin bayonet connector		LED	098 212 152

Zusatzartikel

Produktart <i>product type</i>	Artikeltitel <i>article title</i>	Farbe <i>colour</i>	Art.-Nr. <i>Part No.</i>
Widerstände resistors	LED Widerstand LED resistor		098 292 365
Stecker connector	Stecker 5-polig System Aspöck	gelb yellow	098 295 076
Stecker connector	Stecker 5-polig System Aspöck	grün green	098 295 078

Ⓔ



▪ **Universal Mehrkammerleuchte**

Voll-LED-Heckleuchte; strapazierfähiges Polycarbonatgehäuse; Leuchteinheit komplett vergossen und dadurch absolut dicht; zusätzlicher Widerstand für Blinker notwendig

▪ **universal multi-chamber lights**

Full LED-multi-chamber lights; durable PC shape; lighting unit completely sealed and absolutely tight; additional resistor for indicator necessary

Leuchtenfunktionen

Begrenzungslicht
Blinklicht
Bremslicht

lighting functions

*marker light
indicator
stoptlight*

Zusätzl. Leuchtenfunktionen <i>add. lighting functions</i>	Anschlussspannung <i>connection voltage</i>	Kabellänge <i>cable length</i>	Leuchtmittel <i>illuminant</i>	Anbauseite <i>installation side</i>	Art.-Nr. <i>Part No.</i>
	12 V	500 mm	LED	▶ R	098 212 145
Kennzeichenlicht licence plate light	12 V	500 mm	LED	◀ L	098 212 140



▪ **Universal
 Mehrkammerleuchte**

▪ *universal
 multi-chamber lights*

Leuchtenfunktionen

Blinklicht
 Bremslicht
 Schlusslicht
 Rückstrahler

lighting functions

*indicator
 stoplight
 tail light
 reflector*

Anschlussspannung <i>connection voltage</i>	Kabellänge <i>cable length</i>	Leuchtmittel <i>illuminant</i>	Art.-Nr. <i>Part No.</i>
9-33 V	500 mm	LED	098 212 190



▪ **Universal
 Mehrkammerleuchte**

▪ *universal
 multi-chamber lights*

Leuchtenfunktionen

Blinklicht
 Bremslicht
 Nebelschlusslicht

lighting functions

*indicator
 stoplight
 fog tail light*

Symbolbild *symbol photo*

Anschlussspannung <i>connection voltage</i>	Kabellänge <i>cable length</i>	Leuchtmittel <i>illuminant</i>	Art.-Nr. <i>Part No.</i>
24 V	500 mm	LED	j10.2600.502
12 V	500 mm	LED	j10.2600.002



▪ **ER-X LT3
 Mehrkammerleuchte**

▪ *ER-X LT3
 multi-chamber lights*

Leuchtenfunktionen

Blinklicht
 Bremslicht
 Schlusslicht

lighting functions

*indicator
 stoplight
 tail light*

Zusätzl. Leuchtenfunktionen <i>add. lighting functions</i>	Anschlussspannung <i>connection voltage</i>	Anschlussart <i>connection type</i>	Glasfarbe <i>glass colour</i>	OE- Nr. <i>OE- No.</i>	Art.-Nr. <i>Part No.</i>
Begrenzungslicht marker light	12/24 V	AMP Superseal Kabeldurchführung AMP Superseal wire bushing	rot, orange red, amber	2SD 343 130-011 02.1335.0000 2SD 343 130-157	098 210 390



▪ **Universal
Mehrkammerleuchte**

▪ *universal
multi-chamber lights*

Leuchtenfunktionen

Bremslicht
Schlusslicht

lighting functions

*stoplight
tail light*

Anschlussspannung <i>connection voltage</i>	Anschlussart <i>connection type</i>	OE- Nr. <i>OE- No.</i>	Leuchtmittel <i>illuminant</i>	Art.-Nr. <i>Part No.</i>
9-33 V	Kabel wire	2SA 008 405-011 2SA 008 405-017 2SB 008 405-091	LED	098 212 630



▪ **Universal
Mehrkammerleuchte**

▪ *universal
multi-chamber lights*

Leuchtenfunktionen

Schlusslicht
Bremslicht

lighting functions

*tail light
stoplight*

Anschlussspannung <i>connection voltage</i>	Leuchtmittel <i>illuminant</i>	Art.-Nr. <i>Part No.</i>
9-33 V	LED	098 206 530



▪ **Universal
 Mehrkammerleuchte**

▪ *universal
 multi-chamber lights*

Leuchtenfunktionen

Bremslicht
 Schlusslicht

lighting functions

*stoplight
 tail light*

Sockelausführung <i>socket version</i>	Anschlussleistung <i>connected load</i>	Anschlussspannung <i>connection voltage</i>	Anschlussart <i>connection type</i>	Art.-Nr. <i>Part No.</i>
BAY15d	21/5 W	12/24 V	Kabel wire	098 203 510



▪ **Universal
 Mehrkammerleuchte**

▪ *universal
 multi-chamber lights*

Leuchtenfunktionen

Blinklicht
 Bremslicht
 Schlusslicht

lighting functions

*indicator
 stoplight
 tail light*

Anschlussleistung <i>connected load</i>	Anschlussspannung <i>connection voltage</i>	Anschlussart <i>connection type</i>	OE- Nr. <i>OE- No.</i>	Leuchtmittel <i>illuminant</i>	Art.-Nr. <i>Part No.</i>
15,5 W	24 V	Flachstecker 6,3mm flat connector 6.3mm	TA 001 685-357	LED	098 212 357

Zusatzartikel

Produktart <i>product type</i>	Artikeltitel <i>article title</i>	OE- Nr. <i>OE- No.</i>	Zusätzl. Leuchtenfunktionen <i>add. lighting functions</i>	Art.-Nr. <i>Part No.</i>
Widerstände resistors	LED Widerstand LED resistor		Schlusslicht tail light	098 292 912
Widerstände resistors	LED Widerstand LED resistor		Bremslicht Blinklicht stop light indicator	098 292 924
Widerstände resistors	LED Widerstand LED resistor		Blinklicht indicator	098 292 358
Montageteile mounting hardware	Einbauring installation ring	QXD 997 909-801		098 292 359



■ **Universal
Mehrkammerleuchte**

■ *universal
multi-chamber lights*

Leuchtenfunktionen *lighting functions*

Blinklicht
Bremslicht
Schlusslicht

*indicator
stoplight
tail light*

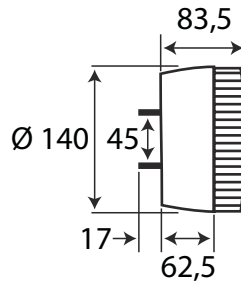

Anschlussspannung <i>connection voltage</i>	Anschlussart <i>connection type</i>	Glas Art <i>type of glass</i>	Glasfarbe <i>glass colour</i>	Leuchtmittel <i>illuminant</i>	Art.-Nr. <i>Part No.</i>
9-32 V	Kabeldurchführung wire bushing	klar clear	weiß white	LED	098 212 367
9-32 V	Kabeldurchführung wire bushing		rot, gelb red, yellow	LED	098 212 368

Zusatzartikel

Produktart <i>product type</i>	Artikeltitel <i>article title</i>	Zusätzl. Leuchtenfunktionen <i>add. lighting functions</i>	Art.-Nr. <i>Part No.</i>
Widerstände resistors	LED Widerstand LED resistor	Schlusslicht tail light	098 292 912
Widerstände resistors	LED Widerstand LED resistor	Bremslicht Blinklicht stop light indicator	098 292 924
Widerstände resistors	LED Widerstand LED resistor	Blinklicht indicator	098 292 358
	Einbauring installation ring		098 292 369



▪ **Universal
 Mehrkammerleuchte**

▪ *universal
 multi-chamber lights*

Leuchtenfunktionen

Blinklicht
 Bremslicht
 Schlusslicht

lighting functions

*indicator
 stoplight
 tail light*



45
 2x M6



Anschlussspannung <i>connection voltage</i>	Leuchtmittel <i>illuminant</i>	Art.-Nr. <i>Part No.</i>
12 V	LED	098 212 342
24 V	LED	098 212 344

Zusatzartikel

Produktart <i>product type</i>	Artikeltitel <i>article title</i>	OE- Nr. <i>OE- No.</i>	Zusätzl. Leuchtenfunktionen <i>add. lighting functions</i>	Art.-Nr. <i>Part No.</i>
Widerstände resistors	LED Widerstand LED resistor		Schlusslicht tail light	098 292 912
Widerstände resistors	LED Widerstand LED resistor		Bremslicht Blinklicht stop light indicator	098 292 924
Widerstände resistors	LED Widerstand LED resistor		Blinklicht indicator	098 292 358
Montageteile mounting hardware	Einbauring installation ring	QXD 997 909-801		098 292 359



▪ **Universal
Mehrkammerleuchte**

▪ *universal
multi-chamber lights*

Leuchtenfunktionen

Blinklicht
Bremslicht
Schlusslicht

lighting functions

*indicator
stoplight
tail light*

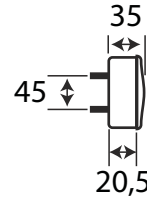

Anschlussspannung <i>connection voltage</i>	Anschlussart <i>connection type</i>	Kabellänge <i>cable length</i>	Leuchtmittel <i>illuminant</i>	Art.-Nr. <i>Part No.</i>
12 V	Kabel wire	500 mm	LED	098 212 372
24 V	Kabel wire	500 mm	LED	098 212 374

Zusatzartikel

Produktart <i>product type</i>	Artikeltitel <i>article title</i>	OE- Nr. <i>OE- No.</i>	Zusätzl. Leuchtenfunktionen <i>add. lighting functions</i>	Art.-Nr. <i>Part No.</i>
Widerstände resistors	LED Widerstand LED resistor		Schlusslicht tail light	098 292 912
Widerstände resistors	LED Widerstand LED resistor		Bremslicht Blinklicht stop light indicator	098 292 924
Widerstände resistors	LED Widerstand LED resistor		Blinklicht indicator	098 292 358
Montageteile mounting hardware	Einbauring installation ring	QXD 997 909-801		098 292 359



▪ **Universal
 Mehrkammerleuchte**

▪ *universal
 multi-chamber lights*

Leuchtenfunktionen

Blinklicht
 Bremslicht
 Schlusslicht

lighting functions

*indicator
 stoplight
 tail light*

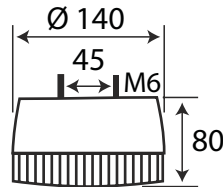

Zusätzl. Leuchtenfunktionen <i>add. lighting functions</i>	Sockelausführung <i>socket version</i>	Anschlussspannung <i>connection voltage</i>	Anschlussart <i>connection type</i>	Art.-Nr. <i>Part No.</i>
	BA15s	12/24 V	Flachstecker 6,3mm flat connector 6.3mm	098 212 352
Kennzeichenlicht licence plate light	BA15s	12/24 V	Flachstecker 6,3mm flat connector 6.3mm	098 212 356

Zusatzartikel

Produktart <i>product type</i>	Artikeltitel <i>article title</i>	OE- Nr. <i>OE- No.</i>	Art.-Nr. <i>Part No.</i>
Lichtscheiben lens	Lichtscheibe lens	QEL 113 324-001	098 292 354
Montageteile mounting hardware	Einbauring installation ring	QXD 997 909-801	098 292 359



▪ **Universal
Mehrkammerleuchte**

Mit Lichtleiter Begrenzungslicht
Alle Funktionen in LED

Leuchtenfunktionen

Blinklicht
Bremslicht
Schlusslicht
Standlicht

▪ **universal
multi-chamber lights**

With light guide marker light
all functions with LED

lighting functions

indicator
stoplight
tail light
parking light

Anschlussspannung connection voltage	Anschlussart connection type	Kabellänge cable length	Leuchtmittel illuminant	Art.-Nr. Part No.
12-36 V	Kabel wire	200 mm	LED	098 212 160
12-36 V	Stecker connector		LED	098 212 162

Zusatzartikel

Produktart product type	Artikeltitel article title	Art.-Nr. Part No.
Widerstände resistors	LED Widerstand LED resistor	098 292 365
Widerstände resistors	LED Widerstand LED resistor	098 292 360



▪ **Universal
Mehrkammerleuchte**

Blinklicht
Bremslicht
Schlusslicht
Rückstrahler

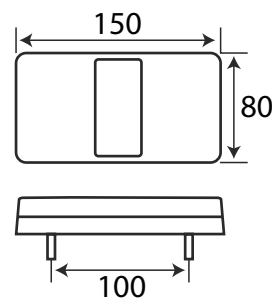

▪ **universal
multi-chamber lights**

indicator
stoplight
tail light
reflector

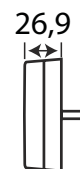

Leuchtmittelfarbe lamp colour	Anschlussspannung connection voltage	Anschlussart connection type	LED Anzahl LED number	Glasfarbe glass colour	Kabellänge cable length	Leuchtmittel illuminant	Art.-Nr. Part No.
weiß white	12/24 V	Kabel wire	24	rot, orange red, amber	300 mm	LED	098 212 120
weiß white	12/24 V	Kabel wire	24	weiß white	300 mm	LED	098 212 125



■ **Universal Mehrkammerleuchte**

■ *universal multi-chamber lights*

Leuchtenfunktionen

Blinklicht
 Bremslicht
 Schlusslicht
 Begrenzungslicht
 Rückstrahler

lighting functions

*indicator
 stoplight
 tail light
 marker light
 reflector*

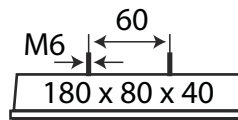

Leuchtmittelfarbe <i>lamp colour</i>	Anschlussspannung <i>connection voltage</i>	Anschlussart <i>connection type</i>	LED Anzahl <i>LED number</i>	Kabellänge <i>cable length</i>	Leuchtmittel <i>illuminant</i>	Art.-Nr. <i>Part No.</i>
weiß white	12/24 V	Kabel wire	40	500 mm	LED	098 212 159



■ **Universal Mehrkammerleuchte**

■ *universal multi-chamber lights*

Heck-, Brems- und Blinkleuchte doppelt belegt

Tail-, stop- and indicator function double assigned

Leuchtenfunktionen

Blinklicht
 Bremslicht
 Schlusslicht
 Schlusslicht 2
 Seitenmarkierungslicht

lighting functions

*indicator
 stoplight
 tail light
 2. tail light
 side marker light*

Zusätzl. Leuchtenfunktionen <i>add. lighting functions</i>	Leuchtmittelfarbe <i>lamp colour</i>	Anschlussart <i>connection type</i>	Glasfarbe <i>glass colour</i>	Leuchtmittel <i>illuminant</i>	Art.-Nr. <i>Part No.</i>
Rückfahrlicht reverse light	weiß white	Kabeldurchführung wire bushing	rot, orange red, amber	LED	098 215 630
Nebelschlusslicht fog tail light	weiß white	Kabeldurchführung wire bushing	rot, orange red, amber	LED	098 215 631
Rückfahrlicht reverse light	weiß white	Kabeldurchführung wire bushing	weiß white	LED	098 215 632
Nebelschlusslicht fog tail light	weiß white	Kabeldurchführung wire bushing	weiß white	LED	098 215 633



▪ **Universal
Mehrkammerleuchte**

▪ *universal
multi-chamber lights*

Zusätzl. Leuchtenfunktionen <i>add. lighting functions</i>	Leuchtmittelfarbe <i>lamp colour</i>	Anschlussart <i>connection type</i>	Glasfarbe <i>glass colour</i>	Leuchtmittel <i>illuminant</i>	Art.-Nr. <i>Part No.</i>
Rückfahrlicht <i>reverse light</i>	weiß <i>white</i>	AMP 1.5	rot <i>red</i>	LED	098 215 634
Nebelschlusslicht <i>fog tail light</i>	weiß <i>white</i>	AMP 1.5	rot <i>red</i>	LED	098 215 635
Rückfahrlicht <i>reverse light</i>	weiß <i>white</i>	AMP 1.5	weiß <i>white</i>	LED	098 215 636
Nebelschlusslicht <i>fog tail light</i>	weiß <i>white</i>	AMP 1.5	weiß <i>white</i>	LED	098 215 637

Zusatzartikel

Produktart <i>product type</i>	Artikeltitel <i>article title</i>	Anschlussart <i>connection type</i>	Art.-Nr. <i>Part No.</i>
Stecker <i>connector</i>	KIT NW 10 Renault, Volvo, DAF LF	AMP 1.5 90°	099 111 493



▪ **Universal
Mehrkammerleuchte**

▪ *universal
multi-chamber lights*

Leuchtenfunktionen	<i>lighting functions</i>
Blinklicht	<i>indicator</i>
Bremslicht	<i>stoplight</i>
Schlusslicht	<i>tail light</i>

Zusätzl. Leuchtenfunktionen <i>add. lighting functions</i>	Sockelausführung <i>socket version</i>	Anschlussspannung <i>connection voltage</i>	OE- Nr. <i>OE- No.</i>	Art.-Nr. <i>Part No.</i>
	BA15s SV8,5-36	12/24 V	2SE 002 776-221 2SE 003 182-021	j10.6025.120
Kennzeichenlicht <i>licence plate light</i>	BA15s SV8,5-36	12/24 V	2SE 003 182-011 2SE 002 776-211	j10.6025.110

Zusatzartikel

Artikeltitel <i>article title</i>	OE- Nr. <i>OE- No.</i>	Art.-Nr. <i>Part No.</i>
Lichtscheibe <i>lens</i>	10.6025.120	j19.6037.120
Lichtscheibe <i>lens</i>	10.6025.110	j19.6037.110



▪ **Universal Mehrkammerleuchte**

▪ *universal multi-chamber lights*

Leuchtenfunktionen

Blinklicht
Bremslicht
Schlusslicht
Nebelschlusslicht
Rückfahrlicht
Rückstrahler

lighting functions

*indicator
stoplight
tail light
fog tail light
reverse light
reflector*

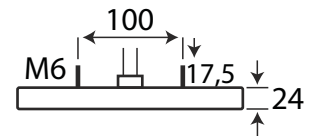
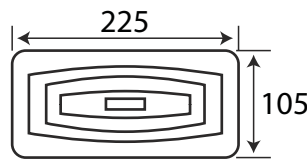

Anschlussspannung connection voltage	Anschlussart connection type	Glasfarbe glass colour	Kabellänge cable length	Leuchtmittel illuminant	Betriebstemperatur temperature	Art.-Nr. Part No.
9-32 V	Kabel wire	rot, weiß red, white	500 mm	LED	-20 bis 50	j10.2300.002



▪ **Universal Mehrkammerleuchte**

▪ *universal multi-chamber lights*

Leuchtenfunktionen

Blinklicht
Bremslicht
Schlusslicht

lighting functions

*indicator
stoplight
tail light*

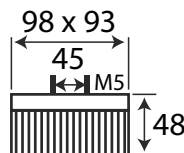

Zusätzl. Leuchtenfunktionen add. lighting functions	Sockelausführung socket version	Anschlussspannung connection voltage	Anschlussart connection type	Art.-Nr. Part No.
	BA15s SV8,5-36	12/24 V	Flachstecker 6,3mm flat connector 6.3mm	098 210 320
Kennzeichenlicht licence plate light	BA15s SV8,5-36	12/24 V	Flachstecker 6,3mm flat connector 6.3mm	098 210 325
Kennzeichenlicht licence plate light	BA15s SV8,5-36	12/24 V	Flachstecker 6,3mm flat connector 6.3mm	098 212 340

Zusatzartikel

Artikeltitle article title	Art.-Nr. Part No.
Lichtscheibe lens	098 292 342



Ⓔ

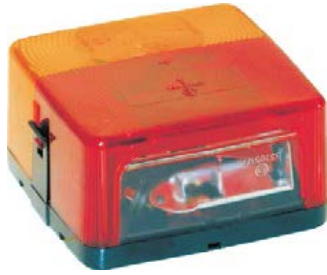

▪ **Universal
Mehrkammerleuchte**

▪ *universal
multi-chamber lights*

Leuchtenfunktionen

Blinklicht
Bremslicht
Schlusslicht
Kennzeichenlicht

lighting functions

*indicator
stoplight
tail light
licence plate light*

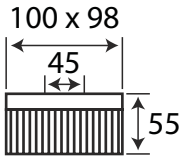

Sockelausführung <i>socket version</i>	Anschlussspannung <i>connection voltage</i>	Art.-Nr. <i>Part No.</i>
BA15s	12/24 V	j10.1002.100

Zusatzartikel

Produktart <i>product type</i>	Artikeltitel <i>article title</i>	Art.-Nr. <i>Part No.</i>
Lichtscheiben <i>lens</i>	Lichtscheibe <i>lens</i>	j19.0007.000

Ⓔ



▪ **Universal
Mehrkammerleuchte**

▪ *universal
multi-chamber lights*

Leuchtenfunktionen

Blinklicht
Bremslicht
Schlusslicht

lighting functions

*indicator
stoplight
tail light*

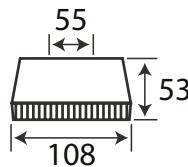

Zusätzl. Leuchtenfunktionen <i>add. lighting functions</i>	Sockelausführung <i>socket version</i>	Anschlussspannung <i>connection voltage</i>	Art.-Nr. <i>Part No.</i>
	BAY15d BA15s	12 V	098 210 360
Kennzeichenlicht <i>licence plate light</i>	BAY15d BA15s	12 V	098 210 361

Ⓔ



▪ **Universal Mehrkammerleuchte**

▪ *universal multi-chamber lights*

Leuchtenfunktionen

Blinklicht
Bremslicht
Schlusslicht

lighting functions

*indicator
stoplight
tail light*

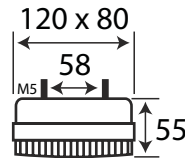

Sockelausführung socket version	Anschlussspannung connection voltage	OE- Nr. OE- No.	Art.-Nr. Part No.
BAY15d BA15s	12/24 V	2SD 997 131-051	098 211 135

Zusatzartikel

Produktart product type	Artikeltitel article title	Art.-Nr. Part No.
Lichtscheiben lens	Lichtscheibe lens	098 291 132

Ⓔ



▪ **Universal Mehrkammerleuchte**

▪ *universal multi-chamber lights*

Leuchtenfunktionen

Blinklicht
Bremslicht
Schlusslicht

lighting functions

*indicator
stoplight
tail light*

Zusätzl. Leuchtenfunktionen add. lighting functions	Anschlussspannung connection voltage	Anschlussart connection type	Art.-Nr. Part No.
	12 V	Stecker 5-polig System "Aspöck" 5-pole connector system "Aspöck"	098 210 330
Kennzeichenlicht licence plate light	12 V	Stecker 5-polig System "Aspöck" 5-pole connector system "Aspöck"	098 210 335



Ⓔ



▪ **Universal
Mehrkammerleuchte**

▪ *universal
multi-chamber lights*

Leuchtenfunktionen

Blinklicht
Bremslicht
Schlusslicht

lighting functions

*indicator
stoplight
tail light*

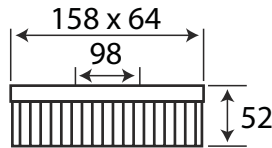

Zusätzl. Leuchtenfunktionen <i>add. lighting functions</i>	Sockelausführung <i>socket version</i>	Anschlussspannung <i>connection voltage</i>	Anschlussart <i>connection type</i>	Anbauseite <i>installation side</i>	Art.-Nr. <i>Part No.</i>
Kennzeichenlicht <i>licence plate light</i>	BA15s	12/24 V	Flachstecker 6,3mm <i>flat connector 6.3mm</i>	◀ L	098 216 014
	BA15s	12/24 V	Flachstecker 6,3mm <i>flat connector 6.3mm</i>	▶ R	j10.6014.121

Zusatzartikel

Produktart <i>product type</i>	Artikeltitel <i>article title</i>	Anbauseite <i>installation side</i>	Art.-Nr. <i>Part No.</i>
Lichtscheiben <i>lens</i>	Lichtscheibe <i>lens</i>	◀ L	098 296 015
Lichtscheiben <i>lens</i>	Lichtscheibe <i>lens</i>	▶ R	j19.6023.121

Ⓔ



▪ **Universal
Mehrkammerleuchte**

▪ *universal
multi-chamber lights*

Leuchtenfunktionen

Blinklicht
Bremslicht
Schlusslicht

lighting functions

*indicator
stoplight
tail light*

Zusätzl. Leuchtenfunktionen <i>add. lighting functions</i>	Sockelausführung <i>socket version</i>	Anschlussspannung <i>connection voltage</i>	Anbauseite <i>installation side</i>	Art.-Nr. <i>Part No.</i>
Kennzeichenlicht <i>licence plate light</i>	BA15s	12/24 V	◀ L	098 210 840
	BA15s	12/24 V	▶ R	098 210 845

Zusatzartikel

Produktart <i>product type</i>	Artikeltitel <i>article title</i>	Anbauseite <i>installation side</i>	Art.-Nr. <i>Part No.</i>
Lichtscheiben <i>lens</i>	Lichtscheibe <i>lens</i>	◀ L	098 290 848
Lichtscheiben <i>lens</i>	Lichtscheibe <i>lens</i>	▶ R	098 290 849

Ⓔ



▪ **Universal Mehrkammerleuchte**

▪ *universal multi-chamber lights*

Leuchtenfunktionen

Blinklicht
Bremslicht
Schlusslicht

lighting functions

*indicator
stoplight
tail light*

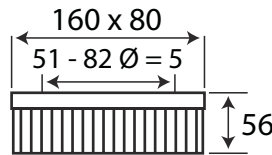

Sockelausführung <i>socket version</i>	Anschlussspannung <i>connection voltage</i>	OE- Nr. <i>OE- No.</i>	Anbauseite <i>installation side</i>	Art.-Nr. <i>Part No.</i>
BA15s BAY15d	12/24 V	2SD 002 582-011	◀ L	098 212 540
BA15s BAY15d	12/24 V	2SD 002 582-021	▶ R	098 212 610

Zusatzartikel

Produktart <i>product type</i>	Artikeltitel <i>article title</i>	OE- Nr. <i>OE- No.</i>	Anbauseite <i>installation side</i>	Art.-Nr. <i>Part No.</i>
Lichtscheiben <i>lens</i>	Lichtscheibe <i>lens</i>	QEL 112 743-001	◀ L	098 292 542
Lichtscheiben <i>lens</i>	Lichtscheibe <i>lens</i>	QEL 112 741-001	▶ R	098 292 612

Ⓔ



▪ **Universal Mehrkammerleuchte**



▪ *universal multi-chamber lights*

Leuchtenfunktionen

Blinklicht
Schlusslicht
Bremslicht
Schlusslicht 2
Rückfahrlicht
Nebelschlusslicht
Rückstrahler

lighting functions

*indicator
tail light
stoplight
2. tail light
reverse light
fog tail light
reflector*

Zusätzl. Leuchtenfunktionen <i>add. lighting functions</i>	Anschlussart <i>connection type</i>	OE- Nr. <i>OE- No.</i>	Steckerbelegung <i>pin assignment</i>	Anbauseite <i>installation side</i>	Art.-Nr. <i>Part No.</i>
	Kabeldurchführung <i>wire bushing</i>				098 212 923
Kennzeichenlicht <i>licence plate light</i>	Kabeldurchführung <i>wire bushing</i>			◀ L	098 212 921
	AMP 1.5	20769784 140 1731			098 212 912
Kennzeichenlicht <i>licence plate light</i>	AMP 1.5	20769783 140 1713		◀ L	098 212 910



▪ **Universal
Mehrkammerleuchte**

▪ **universal
multi-chamber lights**

Leuchtenfunktionen	lighting functions
Blinklicht	indicator
Schlusslicht	tail light
Bremslicht	stoplight
Schlusslicht 2	2. tail light
Rückfahrlicht	reverse light
Nebelschlusslicht	fog tail light

Zusätzl. Leuchtenfunktionen add. lighting functions	Anschlussart connection type	Anbauseite installation side	Art.-Nr. Part No.
Kennzeichenlicht licence plate light	AMP 1.5	◀	098 212 914
	AMP 1.5		098 212 916



▪ **MAN, VW, Universal
Mehrkammerleuchte**

▪ **MAN, VW, Universal
multi-chamber lights**

Leuchtenfunktionen	lighting functions
Blinklicht	indicator
Bremslicht	stoplight
Schlusslicht	tail light
Schlusslicht 2	2. tail light
Rückfahrlicht	reverse light
Nebelschlusslicht	fog tail light
Rückstrahler	reflector

Zusätzl. Leuchtenfunktionen add. lighting functions	Anschlussart connection type	OE- Nr. OE- No.	Steckerbelegung pin assignment	Anbauseite installation side	Art.-Nr. Part No.
	Kabeldurchführung wire bushing	2VP 003 567-121		▶	098 212 761
Kennzeichenlicht licence plate light	Stecker 6-polig System "Schlemmer" 6-pole connector system "Schlemmer"	81.25228.6011		◀	098 212 754
	Stecker 6-polig System "Schlemmer" 6-pole connector system "Schlemmer"			▶	098 212 764

Zusatzartikel

Produktart product type	Artikeltitel article title	OE- Nr. OE- No.	Anschlussart connection type	Zusätzl. Leuchtenfunktionen add. lighting functions	Art.-Nr. Part No.
Stecker connector	Stecker System SCHLEMMER		AMP 1.5 90°		098 292 775
Lichtscheiben lens		QEL 122 689-021 81.25229-6040		Rückstrahler reflector	098 292 753

Ⓔ



▪ **Ecopoint**
Mehrkammerleuchte

▪ **Ecopoint**
multi-chamber lights

Leuchtenfunktionen	lighting functions
Blinklicht	indicator
Bremslicht	stoplight
Schlusslicht	tail light
Schlusslicht 2	2. tail light
Rückfahrlicht	reverse light
Nebelschlusslicht	fog tail light
Positionslicht	position light
Rückstrahler Dreieck	reflector triangular

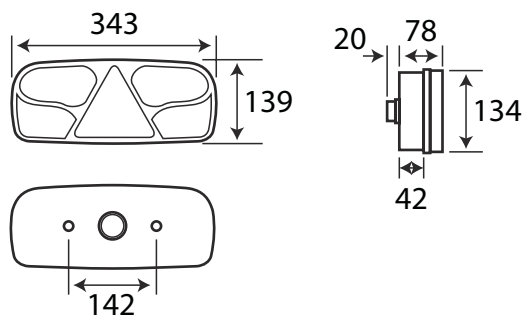

Zusätzl. Leuchtenfunktionen add. lighting functions	Anschlussart connection type	Steckerbelegung pin assignment	Anbauseite installation side	Art.-Nr. Part No.
Kennzeichenlicht licence plate light	Stecker 7-polig ASS2 7-pole connector ASS2		L	098 215 031
	Stecker 7-polig ASS2 7-pole connector ASS2		L	098 215 032
	Stecker 7-polig ASS2 7-pole connector ASS2		R	098 215 034

Zusatzartikel

Produktart product type	Artikeltitel article title	Glasfarbe glass colour	OE- Nr. OE- No.	Art.-Nr. Part No.
Stecker connector	Anschlusssteile-Satz für Leuchten ASS2 connecting part kit for lamps ASS2		13-5626-724	098 291 300
Lichtscheiben lens	Lichtscheibe lens	rot red		098 295 030



▪ **Europoint II
Mehrkammerleuchte**

▪ **Europoint II
multi-chamber lights**

Leuchtenfunktionen / **lighting functions**

- Blinklicht
- Bremslicht
- Schlusslicht
- Schlusslicht 2
- Rückfahrlicht
- Nebelschlusslicht
- Seitenmarkierungslicht
- Rückstrahler Dreieck

- indicator
- stoplight
- tail light
- 2. tail light
- reverse light
- fog tail light
- side marker light
- reflector triangular

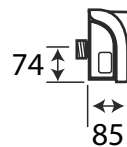
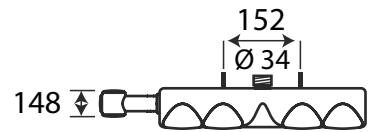
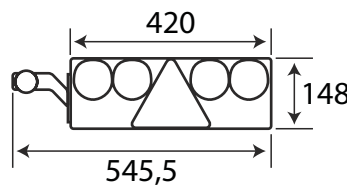

Anschlussart connection type	Steckerbelegung pin assignment	Anbauseite installation side	Art.-Nr. Part No.
Stecker 7-polig ASS2 7-pole connector ASS2			098 215 130
Stecker 7-polig ASS2 7-pole connector ASS2			098 215 132

Zusatzartikel

Produktart product type	Artikeltitel article title	OE- Nr. OE- No.	Farbe colour	Art.-Nr. Part No.
Stecker connector	Anschlusssteile-Satz für Leuchten ASS2 connecting part kit for lamps ASS2	13-5626-724		098 291 300
Lichtscheiben lens	Lichtscheibe lens	18-8560-002		098 295 150
Stecker connector	Stecker connector	13-5626-704	gelb yellow	910 292 778
Stecker connector	Stecker connector	13-5626-951	grün green	910 292 779



▪ **Europoint II
 Mehrkammerleuchte**

▪ **Europoint II
 multi-chamber lights**

Leuchtenfunktionen

- Blinklicht
- Bremslicht
- Schlusslicht
- Schlusslicht 2
- Rückfahrlicht
- Nebelschlusslicht
- Rückstrahler Dreieck

lighting functions

- indicator*
- stoplight*
- tail light*
- 2. tail light*
- reverse light*
- fog tail light*
- reflector triangular*

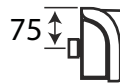
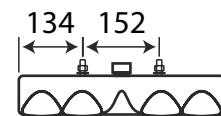
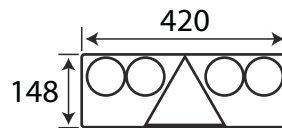

Zusätzl. Leuchtenfunktionen <i>add. lighting functions</i>	Anschlussart <i>connection type</i>	OE- Nr. <i>OE- No.</i>	Steckerbelegung <i>pin assignment</i>	Anbauseite <i>installation side</i>	Art.-Nr. <i>Part No.</i>
	Stecker 7-polig ASS2 7-pole connector ASS2	25-6000-501		◀ L	098 215 100
	Stecker 7-polig ASS2 7-pole connector ASS2	25-6400-501		▶ R	098 215 102
	Stecker 7-polig ASS2 4x2 poliger Stecker 7-pole connector ASS2 4x2 polie connector	25-6200-507		◀ L	098 215 103
	Stecker 7-polig ASS2 4x2 poliger Stecker 7-pole connector ASS2 4x2 polie connector	25-6600-501		▶ R	098 215 104
Schlusslicht LED <i>tail light LED</i>	Stecker 7-polig ASS2 7-pole connector ASS2	25-6000-707		◀ L	098 215 110
Schlusslicht LED <i>tail light LED</i>	Stecker 7-polig ASS2 7-pole connector ASS2	25-6400-707		▶ R	098 215 112



▪ **Europoint II
Mehrkammerleuchte**

▪ **Europoint II
multi-chamber lights**

Zusätzl. Leuchtenfunktionen <i>add. lighting functions</i>	Anschlussart <i>connection type</i>	OE- Nr. <i>OE- No.</i>	Steckerbelegung <i>pin assignment</i>	Anbauseite <i>installation side</i>	Art.-Nr. <i>Part No.</i>
Schlusslicht LED tail light LED	Stecker 7-polig ASS2 4x2 poliger Stecker 7-pole connector ASS2 4x2 polie connector	25-6010-507		◀ L	098 215 120
Schlusslicht LED tail light LED	Stecker 7-polig ASS2 4x2 poliger Stecker 7-pole connector ASS2 4x2 polie connector	25-6410-507		▶ R	098 215 122

Zusatzartikel

Produktart <i>product type</i>	Artikeltitel <i>article title</i>	OE- Nr. <i>OE- No.</i>	Farbe <i>colour</i>	Art.-Nr. <i>Part No.</i>
Stecker connector	Anschlusssteile-Satz für Leuchten ASS2 connecting part kit for lamps ASS2	13-5626-724		098 291 300
Lichtscheiben lens	Lichtscheibe lens	18-8560-002		098 295 150
Stecker connector	Stecker connector	13-5626-704	gelb yellow	910 292 778
Stecker connector	Stecker connector	13-5626-951	grün green	910 292 779



▪ **Europoint III
Mehrkammerleuchte**

▪ **Europoint III
multi-chamber lights**

Mit LED-Lichtleitereinheit ausgestattet

equipped with a LED-fibre light unit

Leuchtenfunktionen

Blinklicht
Bremslicht
Standlicht

lighting functions

*indicator
stoplight
parking light*

Anschlussspannung <i>connection voltage</i>	Anschlussart <i>connection type</i>	OE- Nr. <i>OE- No.</i>	Anbauseite <i>installation side</i>	Art.-Nr. <i>Part No.</i>
24 V	Stecker 7-polig ASS4 7-pole connector ASS4	25-7000-501	◀ L	098 215 500
24 V	Stecker 7-polig ASS4 7-pole connector ASS4	25-7400-501	▶ R	098 215 501
24 V	Stecker 4-polig ASS2 Stecker 7-polig ASS4 4-pole connector ASS2 7-pole connector ASS4	25-7000-511	◀ L	098 215 520

▪ Europoint III
Mehrkammerleuchte▪ Europoint III
multi-chamber lights

Anschlussspannung connection voltage	Anschlussart connection type	OE- Nr. OE- No.	Anbauseite installation side	Art.-Nr. Part No.
24 V	Stecker 4-polig ASS2 Stecker 7-polig ASS4 4-pole connector ASS2 7-pole connector ASS4	25-7400-511	R	098 215 521
24 V	Stecker 7-polig 7-pole connector	25-7000-701	L	098 216 500
24 V	Stecker 7-polig 7-pole connector	25-7400-701	R	098 216 501

Zusatzartikel

Produktart product type	Artikeltitel article title	Kabellänge cable length	OE- Nr. OE- No.	Anbauseite installation side	Farbe colour	Art.-Nr. Part No.
Lichtscheiben lens	Lichtscheibe lens		18-8570-001	L		098 292 500
Lichtscheiben lens	Lichtscheibe lens		18-8570-101	R		098 292 501
LED Einheiten LED Unit	LED Einsatz LED Unit		12-1570-001	L		098 292 510
LED Einheiten LED Unit	LED Einsatz LED Unit		12-1570-101	R		098 292 511
Stecker connector	Stecker connector		13-5626-704		gelb yellow	910 292 778
Stecker connector	Stecker connector		13-5626-951		grün green	910 292 779
Zuleitungen feed lines	Zuleitung wire	5000 mm		L	gelb yellow	68 2408 027
Zuleitungen feed lines	Zuleitung wire	5000 mm		R	grün green	68 2407 027



Ⓔ



▪ **Ecopoint**
Mehrkammerleuchte

▪ **Ecopoint**
multi-chamber lights

Leuchtenfunktionen	lighting functions
Blinklicht	indicator
Bremslicht	stoplight
Schlusslicht	tail light
Schlusslicht 2	2. tail light
Rückfahrlicht	reverse light
Nebelschlusslicht	fog tail light
Begrenzungslicht	marker light
Rückstrahler Dreieck	reflector triangular
Seitenmarkierungslicht	side marker light

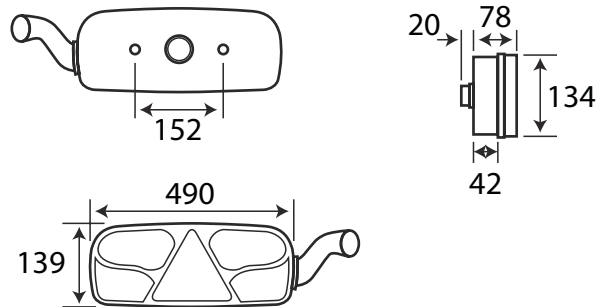

Zusätzl. Leuchtenfunktionen add. lighting functions	Anschlussart connection type	Steckerbelegung pin assignment	Anbauseite installation side	Art.-Nr. Part No.
Kennzeichenlicht licence plate light	Stecker 7-polig ASS2 7-pole connector ASS2			098 215 035
	Stecker 7-polig ASS2 7-pole connector ASS2			098 215 036
	Stecker 7-polig ASS2 7-pole connector ASS2			098 215 038

Zusatzartikel

Produktart product type	Artikeltitel article title	Glasfarbe glass colour	OE- Nr. OE- No.	Sockelausführung socket version	Art.-Nr. Part No.
Stecker connector	Anschlusssteile-Satz für Leuchten ASS2 connecting part kit for lamps ASS2		13-5626-724		098 291 300
Lichtscheiben lens	Lichtscheibe lens	rot red			098 295 030
Lichtscheiben lens	Lichtscheibe lens	rot, weiß, orange red, white, amber		BA9s	098 295 037
Lichtscheiben lens	Lichtscheibe lens	weiß, schwarz white, black			098 295 039



▪ **Ecopoint II**
Mehrkammerleuchte

▪ **Europoint II**
multi-chamber lights

Leuchtenfunktionen

- Blinklicht
- Bremslicht
- Schlusslicht
- Schlusslicht 2
- Rückfahrlicht
- Nebelschlusslicht
- Seitenmarkierungslicht
- Kennzeichenlicht
- Rückstrahler Dreieck

lighting functions

- indicator
- stoplight
- tail light
- 2. tail light
- reverse light
- fog tail light
- side marker light
- licence plate light
- reflector triangular

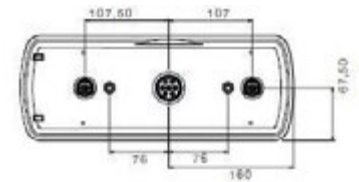
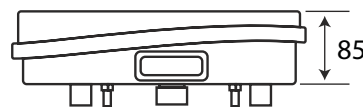
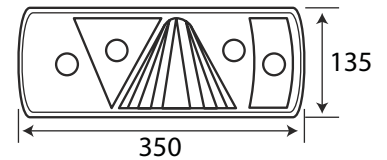
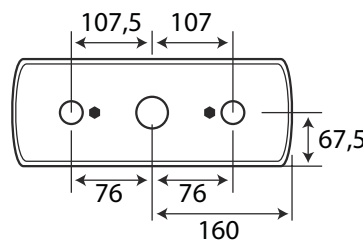

Anschlussart connection type	OE- Nr. OE- No.	Steckerbelegung pin assignment	Anbauseite installation side	Art.-Nr. Part No.
Bajonett Bayonet	25-2800-507			910 212 500
Bajonett Bayonet	25-2900-507			910 212 501

Zusatzartikel

Produktart product type	Artikeltitel article title	OE- Nr. OE- No.	Anbauseite installation side	Farbe colour	Art.-Nr. Part No.
Stecker connector	Stecker connector	13-5626-704		gelb yellow	910 292 778
Stecker connector	Stecker connector	13-5626-951		grün green	910 292 779
Lichtscheiben lens	Lichtscheibe lens				910 292 500
Lichtscheiben lens	Lichtscheibe lens				910 292 501



▪ **Ecopoint II**
Mehrkammerleuchte

▪ **Europoint II**
multi-chamber lights

Leuchtenfunktionen / **lighting functions**

- Blinklicht
- Bremslicht
- Schlusslicht
- Schlusslicht 2
- Rückfahrlicht
- Nebelschlusslicht
- Seitenmarkierungslicht
- Kennzeichenlicht
- Rückstrahler Dreieck
- Begrenzungslicht

- indicator
- stoplight
- tail light
- 2. tail light
- reverse light
- fog tail light
- side marker light
- licence plate light
- reflector triangular
- marker light

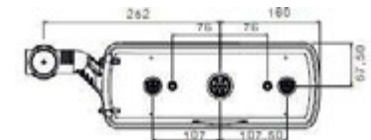
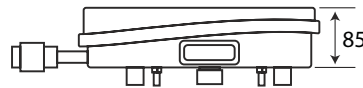
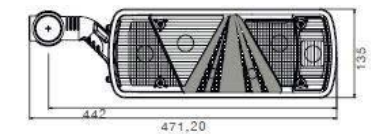
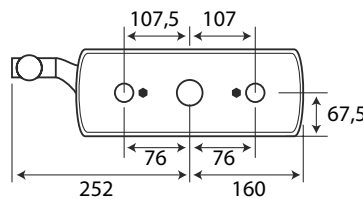

Anschlussart connection type	OE- Nr. OE- No.	Steckerbelegung pin assignment	Anbauseite installation side	Art.-Nr. Part No.
Bajonett Bayonet	25-2810-507			910 212 510
Bajonett Bayonet	25-2910-507			910 212 511

Zusatzartikel

Produktart product type	Artikeltitel article title	OE- Nr. OE- No.	Anbauseite installation side	Farbe colour	Art.-Nr. Part No.
Stecker connector	Stecker connector	13-5626-704		gelb yellow	910 292 778
Stecker connector	Stecker connector	13-5626-951		grün green	910 292 779
Lichtscheiben lens	Lichtscheibe lens				910 292 500
Lichtscheiben lens	Lichtscheibe lens				910 292 501



▪ **Ecopoint II Kögel Mehrkammerleuchte**

▪ **Ecopoint II Kögel multi-chamber lights**

Leuchtenfunktionen	lighting functions
Blinklicht	indicator
Bremslicht	stoplight
Schlusslicht	tail light
Schlusslicht 2	2. tail light
Rückfahrlicht	reverse light
Nebelschlusslicht	fog tail light
Seitenmarkierungslicht	side marker light
Kennzeichenlicht	licence plate light
Rückstrahler Dreieck	reflector triangular
Begrenzungslicht	marker light

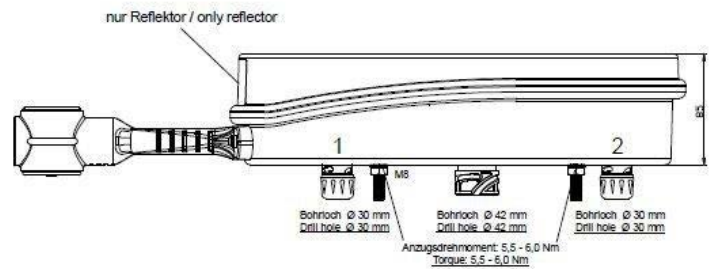
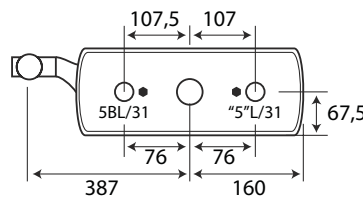

Anschlussart connection type	OE- Nr. OE- No.	Steckerbelegung pin assignment	Anbauseite installation side	Art.-Nr. Part No.
Stecker 7-polig ASS2 2x2 poliger Stecker 7-pole connector ASS2 2x2 pole connector	25-2850-517		L	910 212 520
Stecker 7-polig ASS2 2x2 poliger Stecker 7-pole connector ASS2 2x2 pole connector	25-2950-517		R	910 212 521

Zusatzartikel

Produktart product type	Artikeltitel article title	OE- Nr. OE- No.	Anbauseite installation side	Farbe colour	Art.-Nr. Part No.
Stecker connector	Anschlusssteile-Satz für Leuchten ASS2 connecting part kit for lamps ASS2	13-5626-724			098 291 300
Stecker connector	Stecker connector	13-5626-704		gelb yellow	910 292 778
Stecker connector	Stecker connector	13-5626-951		grün green	910 292 779
	Lichtscheibe lens		L		910 292 510
	Lichtscheibe lens		R		910 292 511



Ⓔ



▪ **Ecopoint LED Hybrid Mehrkammerleuchte**

▪ *Ecopoint LED Hybrid multi-chamber lights*

Leuchtenfunktionen

Blinklicht
Bremslicht
Standlicht

lighting functions

*indicator
stoplight
parking light*

OE- Nr. OE- No.	Leuchtmittel illuminant	Anbauseite installation side	Art.-Nr. Part No.
25-2200-701	LED	◀ L	098 215 431
25-2600-701	LED	▶ R	098 215 434

Ⓔ



▪ **Ecopoint LED Hybrid Mehrkammerleuchte**

▪ *Ecopoint LED Hybrid multi-chamber lights*

Leuchtenfunktionen

Blinklicht
Bremslicht
Standlicht
Positionslicht

lighting functions

*indicator
stoplight
parking light
position light*

OE- Nr. OE- No.	Leuchtmittel illuminant	Anbauseite installation side	Art.-Nr. Part No.
25-2210-701	LED	◀ L	098 215 435
25-2610-701	LED	▶ R	098 215 438

(E)

ADR



▪ **Eco LED**
Mehrkammerleuchte

Leuchtenfunktionen

- Begrenzungslicht
- Blinklicht
- Schlusslicht
- Schlusslicht 2
- Rückfahrlicht
- Nebelschlusslicht
- Seitenmarkierungslicht
- Rückstrahler Dreieck

▪ **Eco LED**
multi-chamber lights

lighting functions

- marker light
- indicator
- tail light
- 2. tail light
- reverse light
- fog tail light
- side marker light
- reflector triangular

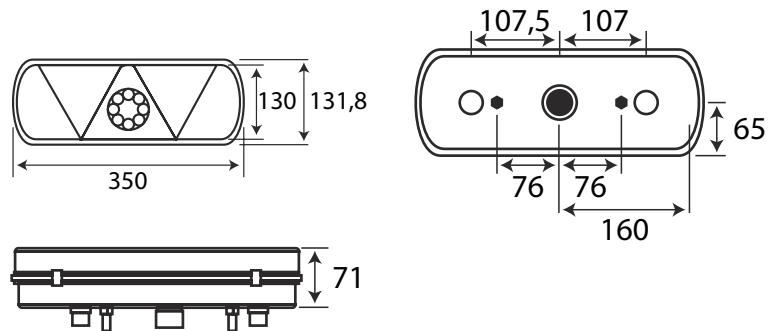

Anschlussspannung connection voltage	OE- Nr. OE- No.	Steckerbelegung pin assignment	Leuchtmittel illuminant	Anbauseite installation side	Art.-Nr. Part No.
24 V	25-3800-507		LED		910 215 900
24 V	25-3900-507		LED		910 215 901

Zusatzartikel

Produktart product type	Artikeltitel article title	OE- Nr. OE- No.	Farbe colour	Art.-Nr. Part No.
Stecker connector	Anschlusssteile-Satz für Leuchten ASS2 connecting part kit for lamps ASS2	13-5626-724		098 291 300
Stecker connector	Stecker connector	13-5626-704	gelb yellow	910 292 778
Stecker connector	Stecker connector	13-5626-951	grün green	910 292 779



▪ **EcoLED Kögel
Mehrkammerleuchte**

▪ **EcoLED Kögel
multi-chamber lights**

Leuchtenfunktionen	lighting functions
Blinklicht	indicator
Bremslicht	stoplight
Schlusslicht	tail light
Schlusslicht 2	2. tail light
Rückfahrlicht	reverse light
Nebelschlusslicht	fog tail light
Begrenzungslicht	marker light
Seitenmarkierungslicht	side marker light
Rückstrahler Dreieck	reflector triangular

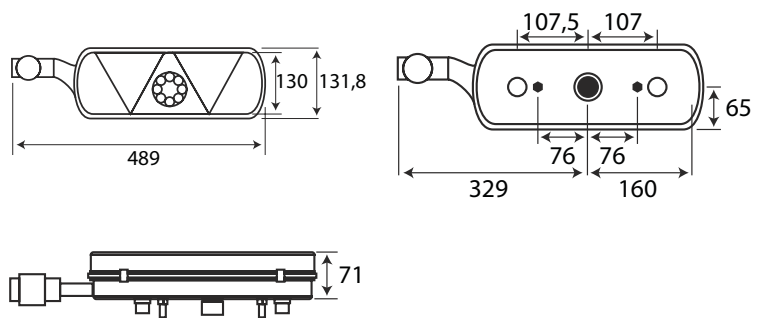

OE- Nr. OE- No.	Steckerbelegung pin assignment	Anbauseite installation side	Art.-Nr. Part No.
25-3860-517			910 215 920
25-3960-517			910 215 921

Zusatzartikel

Produktart product type	Artikeltitel article title	OE- Nr. OE- No.	Farbe colour	Art.-Nr. Part No.
Stecker connector	Anschlusssteile-Satz für Leuchten ASS2 connecting part kit for lamps ASS2	13-5626-724		098 291 300
Stecker connector	Stecker connector	13-5626-704	gelb yellow	910 292 778
Stecker connector	Stecker connector	13-5626-951	grün green	910 292 779

Ⓔ



▪ **Universal für Anhänger Mehrkammerleuchte**

▪ **universal for trailer multi-chamber lights**





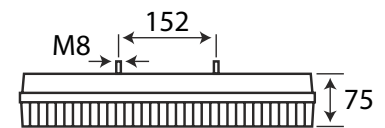
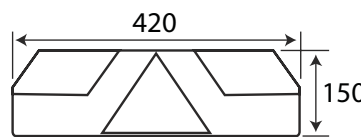

Leuchtenfunktionen

- Blinklicht
- Bremslicht
- Schlusslicht
- Schlusslicht 2
- Rückfahrlicht
- Nebelschlusslicht
- Seitenmarkierungslicht
- Rückstrahler Dreieck
- Positionslicht
- Kennzeichenlicht

lighting functions

- indicator
- stoplight
- tail light
- 2. tail light
- reverse light
- fog tail light
- side marker light
- reflector triangular
- position light
- licence plate light



Anschlussart connection type	Steckerbelegung pin assignment	Kabellänge cable length	Anbauseite installation side	Art.-Nr. Part No.
Stecker 7-polig ASS2 7-pole connector ASS2				098 215 017
Stecker 7-polig ASS2 7-pole connector ASS2				098 215 019
Kabeldurchführung wire bushing				098 215 026
Kabeldurchführung wire bushing				098 215 028
PG Verschraubung screw connection PG		3000 mm		098 215 027
PG Verschraubung screw connection PG		3000 mm		098 215 029

Zusatzartikel

Produktart product type	Artikeltitel article title	OE- Nr. OE- No.	Art.-Nr. Part No.
Stecker connector	Anschlusssteile-Satz für Leuchten ASS2 connecting part kit for lamps ASS2	13-5626-724	098 291 300
Lichtscheiben lens	Lichtscheibe lens		098 295 016



▪ **Universal für Anhänger
Mehrkammerleuchte**

▪ **universal for trailer
multi-chamber lights**

Leuchtenfunktionen

- Blinklicht
- Bremslicht
- Schlusslicht
- Kennzeichenlicht
- Rückstrahler Dreieck

lighting functions

- indicator
- stoplight
- tail light
- licence plate light
- reflector triangular

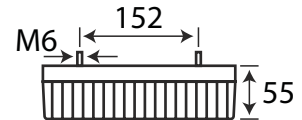
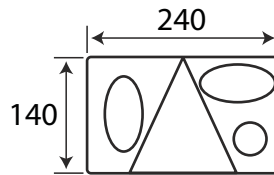

Zusätzl. Leuchtenfunktionen <i>add. lighting functions</i>	Anschlussspannung <i>connection voltage</i>	Anbauseite <i>installation side</i>	Art.-Nr. <i>Part No.</i>
Rückfahrlicht Nebelschlusslicht reverse light fog tail light	12/24 V	▶ R	098 215 200
	12/24 V	▶ R	098 215 210
Rückfahrlicht Nebelschlusslicht reverse light fog tail light	12/24 V	◀ L	098 215 220
	12/24 V	◀ L	098 215 230

Zusatzartikel

Produktart <i>product type</i>	Artikeltitel <i>article title</i>	Farbe <i>colour</i>	Art.-Nr. <i>Part No.</i>
Stecker connector	Stecker 5-polig System Aspöck 5-pole connector system Aspöck	gelb yellow	098 295 076
Stecker connector	Stecker 5-polig System Aspöck 5-pole connector system Aspöck	grün green	098 295 078

Ⓔ

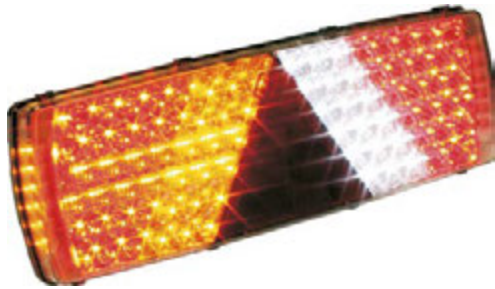





▪ **Universal für Anhänger
 Mehrkammerleuchte**

▪ **universal for trailer
 multi-chamber lights**

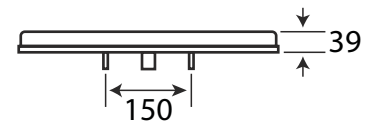
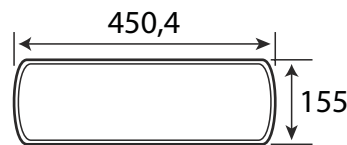
Leuchtenfunktionen *lighting functions*

- | | |
|------------------------|-----------------------------|
| Blinklicht | <i>indicator</i> |
| Bremslicht | <i>stoplight</i> |
| Schlusslicht | <i>tail light</i> |
| Rückfahrlicht | <i>reverse light</i> |
| Nebelschlusslicht | <i>fog tail light</i> |
| Seitenmarkierungslicht | <i>side marker light</i> |
| Rückstrahler Dreieck | <i>reflector triangular</i> |



Anschlussspannung <i>connection voltage</i>	Anschlussart <i>connection type</i>	Steckerbelegung <i>pin assignment</i>	Leuchtmittel <i>illuminant</i>	Anbauseite <i>installation side</i>	Art.-Nr. <i>Part No.</i>
24 V	AMP 1.5		LED		098 215 740
24 V	AMP 1.5		LED		098 215 745

Zusatzartikel

Produktart <i>product type</i>	Artikeltitel <i>article title</i>	Kabellänge <i>cable length</i>	Anschlussart <i>connection type</i>	Zusätzl. Leuchtenfunktionen <i>add. lighting functions</i>	Art.-Nr. <i>Part No.</i>
Widerstände resistors	LED Widerstand LED resistor			Blinklicht indicator	098 292 358
Anschlusskabel connection wire	Anschlusskabel connection cable	4000 mm			098 291 233
Stecker connector	KIT NW 10 Renault, Volvo, DAF LF		AMP 1.5 90°		099 111 493



(E)



▪ **Universal für Anhänger Mehrkammerleuchte**

▪ *universal for trailer multi-chamber lights*

Leuchtenfunktionen	lighting functions
Blinklicht	indicator
Bremslicht	stoplight
Schlusslicht	tail light
Schlusslicht 2	2. tail light
Rückfahrlicht	reverse light
Nebelschlusslicht	fog tail light
Seitenmarkierungslicht	side marker light
Rückstrahler Dreieck	reflector triangular

Anschlussspannung connection voltage	Anschlussart connection type	Steckerbelegung pin assignment	Kabellänge cable length	Leuchtmittel illuminant	Anbauseite installation side	Art.-Nr. Part No.
24 V	AMP 1.5			LED		098 215 754
24 V	AMP 1.5			LED		098 215 755
24 V	Kabel wire		1500 mm	LED		098 215 756
24 V	Kabel wire		1500 mm	LED		098 215 757

Zusatzartikel

Produktart product type	Artikeltitel article title	Anschlussart connection type	Art.-Nr. Part No.
Stecker connector	KIT NW 10 Renault, Volvo, DAF LF	AMP 1.5 90°	099 111 493

**INFORMIEREN SIE SICH
AUCH ÜBER UNSERE
WARN- UND ARBEITSLEUCHTEN**

WWW.RAL.AT



Ⓔ





▪ **Universal für Anhänger Mehrkammerleuchte**

▪ **universal for trailer multi-chamber lights**

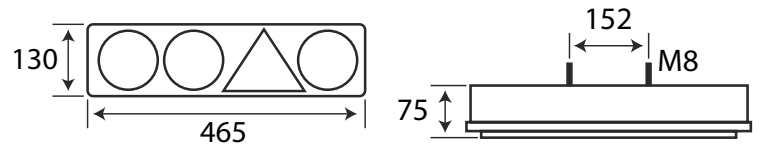
Leuchtenfunktionen	lighting functions
Blinklicht	indicator
Bremslicht	stoplight
Schlusslicht	tail light
Schlusslicht 2	2. tail light
Rückfahrlicht	reverse light
Nebelschlusslicht	fog tail light
Seitenmarkierungslicht	side marker light
Rückstrahler Dreieck	reflector triangular



Anschlussart connection type	Steckerbelegung pin assignment	Kabellänge cable length	Leuchtmittel illuminant	Anbauseite installation side	Art.-Nr. Part No.
AMP 1.5			LED	◀ L	098 215 750
AMP 1.5			LED	▶ R	098 215 751
Kabel wire		1500 mm	LED	◀ L	098 215 752
Kabel wire		1500 mm	LED	▶ R	098 215 753

Zusatzartikel

Produktart product type	Artikeltitel article title	Anschlussart connection type	Art.-Nr. Part No.
Stecker connector	KIT NW 10 Renault, Volvo, DAF LF	AMP 1.5 90°	099 111 493



Ⓔ



▪ **Universal für Anhänger
Mehrkammerleuchte**

▪ **universal for trailer
multi-chamber lights**

Leuchtenfunktionen

- Blinklicht
- Bremslicht
- Schlusslicht
- Schlusslicht 2
- Rückfahrlicht
- Nebelschlusslicht
- Seitenmarkierungslicht
- Kennzeichenlicht
- Rückstrahler Dreieck

lighting functions

- indicator
- stoplight
- tail light
- 2. tail light
- reverse light
- fog tail light
- side marker light
- licence plate light
- reflector triangular

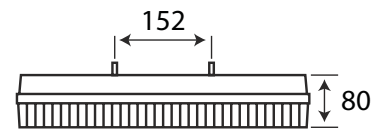
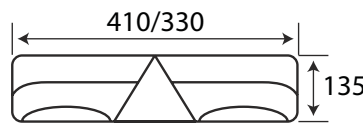

Anschlussart <i>connection type</i>	Kabellänge <i>cable length</i>	Anbauseite <i>installation side</i>	Art.-Nr. <i>Part No.</i>
PG Verschraubung <i>screw connection PG</i>	3000 mm	◀ L	098 213 630
PG Verschraubung <i>screw connection PG</i>	3000 mm	▶ R	098 213 632

Zusatzartikel

Produktart <i>product type</i>	Artikeltitel <i>article title</i>	Anbauseite <i>installation side</i>	Art.-Nr. <i>Part No.</i>
Lichtscheiben <i>lens</i>	Lichtscheibe <i>lens</i>	◀ L	098 293 631
Lichtscheiben <i>lens</i>	Lichtscheibe <i>lens</i>	▶ R	098 293 633

Ⓔ



▪ **Universal für Anhänger Mehrkammerleuchte**

▪ **universal for trailer multi-chamber lights**



Leuchtenfunktionen

- Blinklicht
- Bremslicht
- Schlusslicht
- Schlusslicht 2
- Rückfahrlicht
- Nebelschlusslicht
- Seitenmarkierungslicht
- Rückstrahler Dreieck

lighting functions

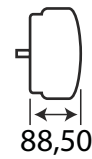
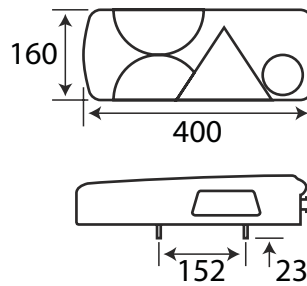
- indicator
- stoplight
- tail light
- 2. tail light
- reverse light
- fog tail light
- side marker light
- reflector triangular



Zusätzl. Leuchtenfunktionen <i>add. lighting functions</i>	Anschlussart <i>connection type</i>	Steckerbelegung <i>pin assignment</i>	Anbauseite <i>installation side</i>	Art.-Nr. <i>Part No.</i>
	AMP 1.5		◀ L	098 212 880
	AMP 1.5		▶ R	098 212 881
Kennzeichenlicht <i>licence plate light</i>	AMP 1.5		◀ L	098 212 882

Zusatzartikel

Produktart <i>product type</i>	Artikeltitel <i>article title</i>	Anbauseite <i>installation side</i>	Anschlussart <i>connection type</i>	Art.-Nr. <i>Part No.</i>
Stecker connector	KIT NW 10 Renault, Volvo, DAF LF		AMP 1.5 90°	099 111 493
Lichtscheiben lens	Lichtscheibe lens	◀ L		098 292 888
Lichtscheiben lens	Lichtscheibe lens	▶ R		098 292 889



(E)

▪ **Universal für Anhänger
Mehrkammerleuchte**

▪ **universal for trailer
multi-chamber lights**

Leuchtenfunktionen	lighting functions
Blinklicht	indicator
Bremslicht	stoplight
Schlusslicht	tail light
Schlusslicht 2	2. tail light
Rückfahrlicht	reverse light
Nebelschlusslicht	fog tail light
Rückstrahler Dreieck	reflector triangular

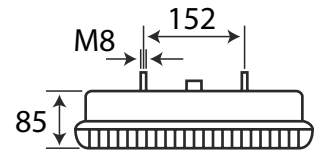
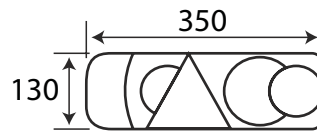

Zusätzl. Leuchtenfunktionen add. lighting functions	Steckerbelegung pin assignment	Anbauseite installation side	Art.-Nr. Part No.
Kennzeichenlicht licence plate light		◀ L	098 212 920
		▶ R	098 212 922

Zusatzartikel

Produktart product type	Artikeltitel article title	Anbauseite installation side	Anschlussart connection type	Art.-Nr. Part No.
Lichtscheiben lens	Lichtscheibe lens	◀ L		098 292 928
Lichtscheiben lens	Lichtscheibe lens	▶ R		098 292 929
Stecker connector	KIT NW 10 Renault, Volvo, DAF LF		AMP 1.5 90°	099 111 493



Ⓔ



▪ **Universal für Anhänger Mehrkammerleuchte**

▪ *universal for trailer multi-chamber lights*

Leuchtenfunktionen	lighting functions
Blinklicht	indicator
Bremslicht	stoplight
Schlusslicht	tail light
Schlusslicht 2	2. tail light
Rückfahrlicht	reverse light
Nebelschlusslicht	fog tail light
Seitenmarkierungslicht	side marker light
Rückstrahler Dreieck	reflector triangular

Anschlussspannung connection voltage	Anschlussart connection type	Steckerbelegung pin assignment	Kabellänge cable length	Leuchtmittel illuminant	Anbauseite installation side	Art.-Nr. Part No.
24 V	AMP 1.5			LED	◀ L	098 215 760
24 V	AMP 1.5			LED	▶ R	098 215 761
24 V	Kabel wire		1500 mm	LED	◀ L	098 215 762
24 V	Kabel wire		1500 mm	LED	▶ R	098 215 763

Zusatzartikel

Produktart product type	Artikeltitel article title	Anschlussart connection type	Art.-Nr. Part No.
Stecker connector	KIT NW 10 Renault, Volvo, DAF LF	AMP 1.5 90°	099 111 493



▪ für Anhänger Krone
Mehrkammerleuchte

▪ for trailer Krone
multi-chamber lights

Leuchtenfunktionen	lighting functions
Blinklicht	indicator
Bremslicht	stoplight
Schlusslicht	tail light
Schlusslicht 2	2. tail light
Rückfahrlicht	reverse light
Seitenmarkierungslicht	side marker light
Begrenzungslicht	marker light
Nebelschlusslicht	fog tail light
Rückstrahler Dreieck	reflector triangular

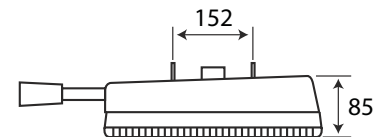
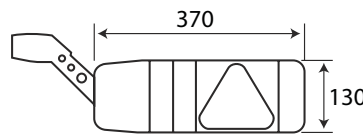

Anschlussart connection type	OE- Nr. OE- No.	Anbauseite installation side	Art.-Nr. Part No.
Kabeldurchführung wire bushing	2VP 340 931-111	◀ L	098 212 536
Kabeldurchführung wire bushing	2VP 340 931-101	▶ R	098 212 537

Zusatzartikel

Produktart product type	Artikeltitel article title	Glasfarbe glass colour	Kabellänge cable length	OE- Nr. OE- No.	Anbauseite installation side	Anschlussart connection type	Art.-Nr. Part No.
Lichtscheiben lens	Lichtscheibe lens			9EL 340 829-031	◀ L		098 292 514
Begrenzungsleuchte marker lamp	Begrenzungsleuchte marker lamp	klar, rot clear, red	1000 mm	2XS 340 827-011	◀ L	Kabel wire	098 241 310
Lichtscheiben lens	Lichtscheibe lens			9EL 340 829-021	▶ R		098 292 515



▪ für Anhänger Krone
 Mehrkammerleuchte



▪ for trailer Krone
 multi-chamber lights

Leuchtenfunktionen

- Blinklicht
- Bremslicht
- Schlusslicht
- Schlusslicht 2
- Rückfahrlicht
- Nebelschlusslicht
- Seitenmarkierungslicht
- Begrenzungslicht
- Rückstrahler Dreieck

lighting functions

- indicator
- stoplight
- tail light
- 2. tail light
- reverse light
- fog tail light
- side marker light
- marker light
- reflector triangular

Anschlussart connection type	OE- Nr. OE- No.	Steckerbelegung pin assignment	Anbauseite installation side	Art.-Nr. Part No.
Stecker 7-polig EasyConn II 7-pole connector EasyConn II	2VP 340 930-111		◀ L	098 212 538
Stecker 7-polig EasyConn II 7-pole connector EasyConn II	2VP 340 930-101		▶ R	098 212 539

Zusatzartikel

Produktart product type	Artikeltitel article title	Glasfarbe glass colour	Kabellänge cable length	OE- Nr. OE- No.	Anbauseite installation side	Anschlussart connection type	Art.-Nr. Part No.
Stecker connector	Gegenstecker connector			9XX 340 883-001			099 111 800
Begrenzungsleuchte marker lamp	Begrenzungsleuchte marker lamp	klar, rot clear, red	1000 mm	2XS 340 827-011	◀ L	Kabel wire	098 241 310
Lichtscheiben lens	Lichtscheibe lens			9EL 340 829-031	◀ L		098 292 514
Lichtscheiben lens	Lichtscheibe lens			9EL 340 829-021	▶ R		098 292 515



▪ für Anhänger Kögel
Mehrkammerleuchte

▪ for trailer Kögel
multi-chamber lights

Leuchtenfunktionen

- Blinklicht
- Bremslicht
- Schlusslicht
- Schlusslicht 2
- Rückfahrlicht
- Nebelschlusslicht
- Seitenmarkierungslicht
- Rückstrahler Dreieck

lighting functions

- indicator
- stoplight
- tail light
- 2. tail light
- reverse light
- fog tail light
- side marker light
- reflector triangular

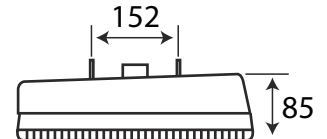
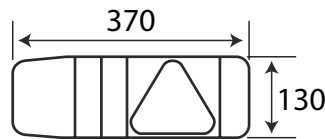

Anschlussart connection type	OE- Nr. OE- No.	Anbauseite installation side	Art.-Nr. Part No.
Kabeldurchführung wire bushing	2VP 340 931-011	◀ L	098 212 532
Kabeldurchführung wire bushing	2VP 340 931-001	▶ R	098 212 533

Zusatzartikel

Produktart product type	Artikeltitel article title	OE- Nr. OE- No.	Anbauseite installation side	Art.-Nr. Part No.
Lichtscheiben lens	Lichtscheibe lens	9EL 340 829-031	◀ L	098 292 514
Lichtscheiben lens	Lichtscheibe lens	9EL 340 829-021	▶ R	098 292 515



▪ für Anhänger Kögel
 Mehrkammerleuchte



▪ for trailer Kögel
 multi-chamber lights

Leuchtenfunktionen

- Blinklicht
- Bremslicht
- Schlusslicht
- Schlusslicht 2
- Rückfahrlicht
- Nebelschlusslicht
- Seitenmarkierungslicht
- Rückstrahler Dreieck

lighting functions

- indicator
- stoplight
- tail light
- 2. tail light
- reverse light
- fog tail light
- side marker light
- reflector triangular

Anschlussart connection type	OE- Nr. OE- No.	Steckerbelegung pin assignment	Anbauseite installation side	Art.-Nr. Part No.
Stecker 7-polig EasyConn II 7-pole connector EasyConn II	2VP 340 930-031		◀ L	098 212 534
Stecker 7-polig EasyConn II 7-pole connector EasyConn II	2VP 340 930-021		▶ R	098 212 535

Zusatzartikel

Produktart product type	Artikeltitel article title	OE- Nr. OE- No.	Anbauseite installation side	Art.-Nr. Part No.
Stecker connector	Gegenstecker connector	9XX 340 883-001		099 111 800
Lichtscheiben lens	Lichtscheibe lens	9EL 340 829-031	◀ L	098 292 514
Lichtscheiben lens	Lichtscheibe lens	9EL 340 829-021	▶ R	098 292 515



▪ für Anhänger Kögel
Mehrkammerleuchte

▪ for trailer Kögel
multi-chamber lights

Leuchtenfunktionen	lighting functions
Blinklicht	indicator
Bremslicht	stoplight
Schlusslicht	tail light
Schlusslicht 2	2. tail light
Rückfahrlicht	reverse light
Nebelschlusslicht	fog tail light
Seitenmarkierungslicht	side marker light
Rückstrahler Dreieck	reflector triangular
Begrenzungslicht	marker light

Anschlussart connection type	OE- Nr. OE- No.	Leuchtmittel illuminant	Anbauseite installation side	Art.-Nr. Part No.
Stecker 7-polig EasyConn II 7-pole connector EasyConn II	2VP 340 940-111	LED	◀ L	198 212 530
Stecker 7-polig EasyConn II 7-pole connector EasyConn II	2VP 340 940-101	LED	▶ R	198 212 531

Zusatzartikel

Produktart product type	Artikeltitel article title	OE- Nr. OE- No.	Anbauseite installation side	Art.-Nr. Part No.
Stecker connector	Gegenstecker connector	9XX 340 883-001		099 111 800
Lichtscheiben lens	Lichtscheibe lens	QEL 340 829-051	◀ L	098 292 512
Lichtscheiben lens	Lichtscheibe lens	QEL 340 829-061	▶ R	098 292 513

Ⓔ



▪ für Anhänger Kögel, Schmitz Mehrkammerleuchte

▪ for trailer Kögel, Schmitz multi-chamber lights



Leuchtenfunktionen

Blinklicht
 Bremslicht
 Schlusslicht
 Schlusslicht 2
 Rückfahrlicht
 Nebelschlusslicht

lighting functions

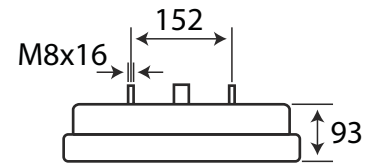
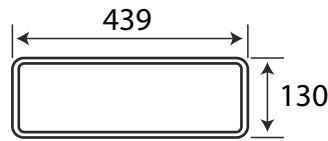
indicator
 stoplight
 tail light
 2. tail light
 reverse light
 fog tail light



Zusätzl. Leuchtenfunktionen add. lighting functions	Anschlussart connection type	OE- Nr. OE- No.	Steckerbelegung pin assignment	Kabellänge cable length	Art.-Nr. Part No.
	Stecker 6-polig flache Pins 6-pole connector flat pins	2SK 340-101-021 2SK 340-101-271 2SK 340-101-277			098 214 260
Seitenmarkierungslicht side marker light	Stecker 6-polig flache Pins 6-pole connector flat pins	2SK 340-101-001 2SK 340-101-011 2SK 340-101-017		1800 mm	098 214 270
Seitenmarkierungslicht side marker light	Stecker 6-polig flache Pins 6-pole connector flat pins	2SK 340-101-221 2SK 340-101-227			098 214 290

Zusatzartikel

Produktart product type	Artikeltitel article title	OE- Nr. OE- No.	Art.-Nr. Part No.
Lichtscheiben lens	Lichtscheibe lens	QEL 340 201-001 QEL 340 201-008 QEL 340 201-018	098 294 292



Ⓔ



▪ für Anhänger Kögel, Schmitz Mehrkammerleuchte

▪ for trailer Kögel, Schmitz multi-chamber lights

Leuchtenfunktionen	lighting functions
Blinklicht	indicator
Bremslicht	stoplight
Schlusslicht	tail light
Schlusslicht 2	2. tail light
Rückfahrlicht	reverse light
Nebelschlusslicht	fog tail light

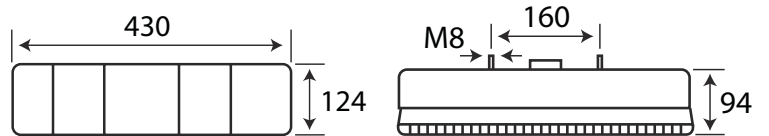

Zusätzl. Leuchtenfunktionen add. lighting functions	OE- Nr. OE- No.	Steckerbelegung pin assignment	Anbauseite installation side	Art.-Nr. Part No.
Kennzeichenlicht licence plate light	2SK 005 883-011 2SK 005 883-031			098 212 711
	2SK 005 883-021			098 212 721

Zusatzartikel

Produktart product type	Artikeltitel article title	OE- Nr. OE- No.	Art.-Nr. Part No.
Lichtscheiben lens	Lichtscheibe lens	QEL 135 548-001	098 292 715

Ⓔ



▪ für Anhänger Kögel, Krone Schmitz Mehrkammerleuchte

▪ for trailer Kögel, Krone, Schmitz multi-chamber lights

Leuchtenfunktionen

Blinklicht
Bremslicht
Schlusslicht
Schlusslicht 2
Rückfahrlicht
Nebelschlusslicht
Seitenmarkierungslicht
Rückstrahler Dreieck

lighting functions

indicator
stoplight
tail light
2. tail light
reverse light
fog tail light
side marker light
reflector triangular

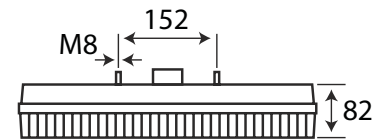
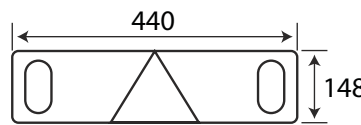

Anschlussart connection type	OE- Nr. OE- No.	Anbauseite installation side	Art.-Nr. Part No.
PG Verschraubung screw connection PG	2VP 340 450-021	▶ R	098 214 210
PG Verschraubung screw connection PG	2VP 240 450-031	◀ L	098 214 220

Zusatzartikel

Produktart product type	Artikeltitel article title	OE- Nr. OE- No.	Art.-Nr. Part No.
Lichtscheiben lens	Lichtscheibe lens	QEL 340 208-001	098 294 212

BESUCHEN SIE
UNSERE HOMEPAGE
WWW.FAHRZEUGBEDARF.AT





Ⓔ



▪ für Anhänger Kögel, Krone, Schmitz Mehrkammerleuchte

▪ for trailer Kögel, Krone, Schmitz multi-chamber lights

Leuchtenfunktionen	lighting functions
Blinklicht	indicator
Bremslicht	stoplight
Schlusslicht	tail light
Schlusslicht 2	2. tail light
Rückfahrlicht	reverse light
Nebelschlusslicht	fog tail light
Seitenmarkierungslicht	side marker light
Rückstrahler Dreieck	reflector triangular

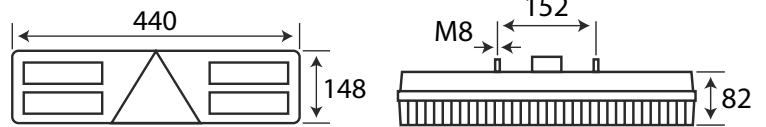

Anschlussart connection type	OE- Nr. OE- No.	Steckerbelegung pin assignment	Kabellänge cable length	Anbauseite installation side	Art.-Nr. Part No.
Stecker 6-polig flache Pins Kabel mit Stecker 6-pole connector flat pins wire with connector	2VP 340 450-141		1700 mm	R	098 214 230
Stecker 6-polig flache Pins Kabel mit Stecker 6-pole connector flat pins wire with connector	2VP 340 450-151		1700 mm	L	098 214 240

Zusatzartikel

Produktart product type	Artikeltitel article title	OE- Nr. OE- No.	Art.-Nr. Part No.
Lichtscheiben lens	Lichtscheibe lens	QEL 340 208-021	098 294 232



▪ **Eco LED**
Mehrkammerleuchte

▪ **Eco LED**
multi-chamber lights

Leuchtenfunktionen	lighting functions
Begrenzungslicht	marker light
Blinklicht	indicator
Schlusslicht	tail light
Schlusslicht 2	2. tail light
Rückfahrlicht	reverse light
Nebelschlusslicht	fog tail light
Seitenmarkierungslicht	side marker light
Rückstrahler Dreieck	reflector triangular

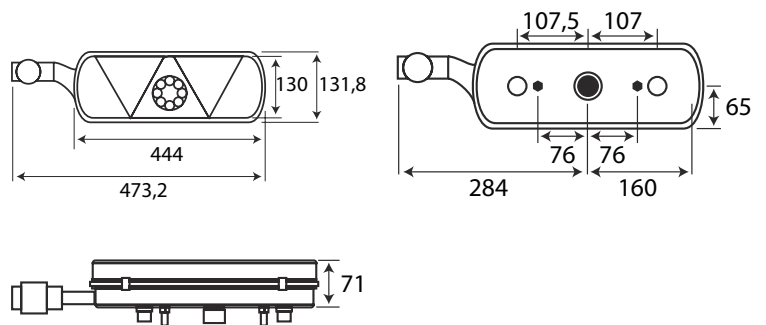

Anschlussspannung connection voltage	OE- Nr. OE- No.	Steckerbelegung pin assignment	Leuchtmittel illuminant	Art.-Nr. Part No.
24 V	25-3920-517		LED	910 215 910

Zusatzartikel

Produktart product type	Artikeltitel article title	OE- Nr. OE- No.	Farbe colour	Art.-Nr. Part No.
Stecker connector	Anschlusssteile-Satz für Leuchten ASS2 connecting part kit for lamps ASS2	13-5626-724		098 291 300
Stecker connector	Stecker connector	13-5626-704	gelb yellow	910 292 778
Stecker connector	Stecker connector	13-5626-951	grün green	910 292 779



▪ **Europoint III
Mehrkammerleuchte**

Mit LED-Lichtleitereinheit ausgestattet

▪ **Europoint III
multi-chamber lights**

fitted with a LED-fibre light unit

Leuchtenfunktionen	lighting functions
Blinklicht	indicator
Bremslicht	stoplight
Standlicht	parking light

Zusätzl. Leuchtenfunktionen add. lighting functions	Anschlussspannung connection voltage	Anschlussart connection type	OE- Nr. OE- No.	Anbauseite installation side	Art.-Nr. Part No.
Begrenzungslicht marker light	24 V	Stecker 7-polig ASS4 7-pole connector ASS4	25-7020-501	◀ L	098 215 510
Begrenzungslicht marker light	24 V	Stecker 7-polig ASS4 7-pole connector ASS4	25-7420-501	▶ R	098 215 511

Zusatzartikel

Produktart product type	Artikeltitel article title	Kabellänge cable length	OE- Nr. OE- No.	Anbauseite installation side	Farbe colour	Art.-Nr. Part No.
Lichtscheiben lens	Lichtscheibe lens		18-8570-001	◀ L		098 292 500
Lichtscheiben lens	Lichtscheibe lens		18-8570-101	▶ R		098 292 501
LED Einheiten LED Unit	LED Einsatz LED Unit		12-1570-001	◀ L		098 292 510
LED Einheiten LED Unit	LED Einsatz LED Unit		12-1570-101	▶ R		098 292 511
Stecker connector	Stecker connector		13-5626-704		gelb yellow	910 292 778
Stecker connector	Stecker connector		13-5626-951		grün green	910 292 779
Zuleitungen feed lines	Zuleitung wire	5000 mm		◀ L	gelb yellow	68 2408 027
Zuleitungen feed lines	Zuleitung wire	5000 mm		▶ R	grün green	68 2407 027



▪ **Europoint III Mehrkammerleuchte**

Mit LED-Lichtleitereinheit ausgestattet

▪ **Europoint III multi-chamber lights**

fitted with a LED-fibre light unit

Leuchtenfunktionen	lighting functions
Blinklicht	indicator
Bremslicht	stoplight
Standlicht	parking light

Zusätzl. Leuchtenfunktionen add. lighting functions	Anschlussspannung connection voltage	Anschlussart connection type	OE- Nr. OE- No.	Anbauseite installation side	Art.-Nr. Part No.
Begrenzungslicht marker light	24 V	Stecker 4-polig ASS2 Stecker 7-polig ASS4 4-pole connector ASS2 7-pole connector ASS4	25-7020-511	◀ L	098 215 530
Begrenzungslicht marker light	24 V	Stecker 4-polig ASS2 Stecker 7-polig ASS4 4-pole connector ASS2 7-pole connector ASS4	25-7420-511	▶ R	098 215 531

Zusatzartikel

Produktart product type	Artikeltitel article title	Kabellänge cable length	OE- Nr. OE- No.	Anbauseite installation side	Farbe colour	Art.-Nr. Part No.
Lichtscheiben lens	Lichtscheibe lens		18-8570-001	◀ L		098 292 500
Lichtscheiben lens	Lichtscheibe lens		18-8570-101	▶ R		098 292 501
LED Einheiten LED Unit	LED Einsatz LED Unit		12-1570-001	◀ L		098 292 510
LED Einheiten LED Unit	LED Einsatz LED Unit		12-1570-101	▶ R		098 292 511
Stecker connector	Stecker connector		13-5626-704		gelb yellow	910 292 778
Stecker connector	Stecker connector		13-5626-951		grün green	910 292 779
Zuleitungen feed lines	Zuleitung wire	5000 mm		◀ L	gelb yellow	68 2408 027
Zuleitungen feed lines	Zuleitung wire	5000 mm		▶ R	grün green	68 2407 027

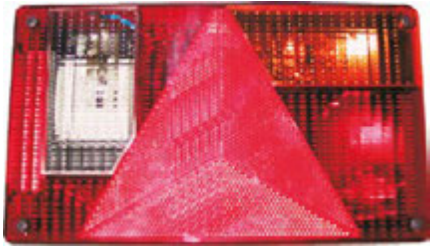

▪ für Anhänger Kögel, Schmitz Mehrkammerleuchte

▪ for trailer Kögel, Schmitz multi-chamber lights

Leuchtenfunktionen

Blinklicht
Bremslicht
Schlusslicht
Schlusslicht 2
Rückfahrlicht
Nebelschlusslicht

lighting functions

indicator
stoplight
tail light
2. tail light
reverse light
fog tail light

Zusätzl. Leuchtenfunktionen <i>add. lighting functions</i>	Anschlussspannung <i>connection voltage</i>	Anbauseite <i>installation side</i>	Art.-Nr. <i>Part No.</i>
Kennzeichenlicht licence plate light	12/24 V	R	j10.2070.120
	12/24 V	R	j10.2070.160
Kennzeichenlicht licence plate light	12/24 V	L	j10.2070.110
Kennzeichenlicht licence plate light	12/24 V	R	j10.2070.140

KENNZEICHENLEUCHTEN

LICENCE PLATE LAMPS





▪ **CNH Steyr**
Kennzeichenleuchte

▪ *CNH Steyr*
licence plate lamp

Lochabstand <i>hole distance</i>	Sockelausführung <i>socket version</i>	Anschlussspannung <i>connection voltage</i>	Anschlussart <i>connection type</i>	Art.-Nr. <i>Part No.</i>
45 mm	BA15s	12 V	Flachstecker 6,3mm Kabeldurchführung flat connector 6.3mm wire bushing	j13.4006.100

Ⓔ



▪ **Universal**
Kennzeichenleuchte

▪ *universal*
licence plate lamp

Anschlussspannung <i>connection voltage</i>	Anschlussart <i>connection type</i>	LED Anzahl <i>LED number</i>	Kabellänge <i>cable length</i>	Leuchtmittel <i>illuminant</i>	Art.-Nr. <i>Part No.</i>
12 V	Flachstecker 6,3mm Kabeldurchführung flat connector 6.3mm wire bushing	6		LED	098 254 242
24 V	Flachstecker 6,3mm Kabeldurchführung flat connector 6.3mm wire bushing	6		LED	098 254 244
12 V	Click-In	6	500 mm	LED	098 254 245
24 V	Click-In	6	500 mm	LED	098 254 247

Ⓔ



▪ **Universal
 Kennzeichenleuchte**

▪ *universal
 licence plate lamp*

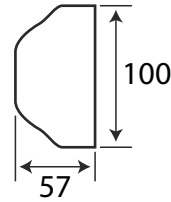

Anschlussspannung connection voltage	Anschlussart connection type	LED Anzahl LED number	Kabellänge cable length	Leuchtmittel illuminant	Art.-Nr. Part No.
12 V	Flachstecker 6,3mm Kabeldurchführung flat connector 6.3mm wire bushing	6		LED	098 254 243
24 V	Flachstecker 6,3mm Kabeldurchführung flat connector 6.3mm wire bushing	6		LED	098 254 246
12 V	Click-In	6	500 mm	LED	098 254 248
24 V	Click-In	6	500 mm	LED	098 254 249

Ⓔ



▪ **Universal
 Kennzeichenleuchte**

▪ *universal
 licence plate lamp*

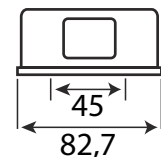
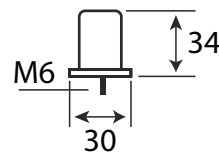

Anschlussspannung connection voltage	Anschlussart Anschlussart	LED Anzahl LED number	Kabellänge cable length	Leuchtmittel illuminant	Art.-Nr. Part No.
12/24 V		2	200 mm	LED	098 254 114
12/24 V	Click-In	2	500 mm	LED	098 254 116
12/24 V		2	200 mm	LED	098 254 115
12/24 V	Click-In	2	500 mm	LED	098 254 117



(E)



▪ **Universal
Kennzeichenleuchte**

▪ *universal
licence plate lamp*

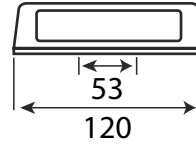
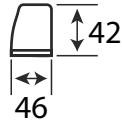

Anschlussspannung <i>connection voltage</i>	Kabellänge <i>cable length</i>	Leuchtmittel <i>illuminant</i>	Art.-Nr. <i>Part No.</i>
10-30 V	300 mm	LED	098 254 230

(E)



▪ **Universal
Kennzeichenleuchte**

▪ *universal
licence plate lamp*

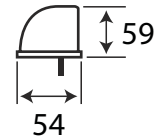
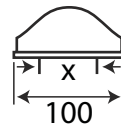

x = 45 / 72 / 75mm

Sockelausführung <i>socket version</i>	Anschlussspannung <i>connection voltage</i>	Anschlussart <i>connection type</i>	Art.-Nr. <i>Part No.</i>
BA15s	12/24 V	Flachstecker 6,3mm Kabeldurchführung flat connector 6.3mm wire bushing	098 254 096

(E)



▪ **Universal
Kennzeichenleuchte**

▪ *universal
licence plate lamp*

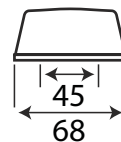
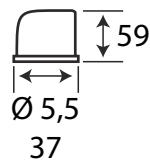

Sockelausführung <i>socket version</i>	Anschlussspannung <i>connection voltage</i>	Anschlussart <i>connection type</i>	Produktlinie <i>product line</i>	Art.-Nr. <i>Part No.</i>
SV8,5-36	12/24 V	Flachstecker 6,3mm Kabeldurchführung flat connector 6.3mm wire bushing	Eco	098 254 170
SV8,5-36	12/24 V	Flachstecker 6,3mm Kabeldurchführung flat connector 6.3mm wire bushing	Premium	098 254 171

Ⓔ



▪ **Universal
 Kennzeichenleuchte**

▪ *universal
 licence plate lamp*

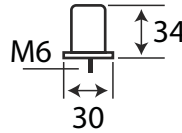

Sockelausführung socket version	Anschlussspannung connection voltage	Anschlussart connection type	OE- Nr. OE- No.	Produktlinie product line	Art.-Nr. Part No.
SV8,5-36	12/24 V	Flachstecker 6,3mm Kabeldurchführung flat connector 6.3mm wire bushing	2KA 001 389-101	Eco	098 254 111
SV8,5-36	12/24 V	Flachstecker 6,3mm Kabeldurchführung flat connector 6.3mm wire bushing	2KA 001389-101	Premium	098 254 112



▪ **Universal
 Kennzeichenleuchte**

▪ *universal
 licence plate lamp*

Lochabstand hole distance	Sockelausführung socket version	Anschlussspannung connection voltage	Anschlussart connection type	Art.-Nr. Part No.
45 mm	BA15s	12/24 V	Flachstecker 6,3mm Kabeldurchführung flat connector 6.3mm wire bushing	998 254 160
45 mm	BA15s	12/24 V	Flachstecker 6,3mm Kabeldurchführung flat connector 6.3mm wire bushing	098 254 161



Ⓔ



▪ **Universal
Kennzeichenleuchte**

▪ *universal
licence plate lamp*

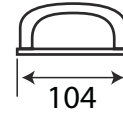
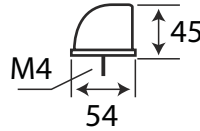

Lochabstand hole distance	Sockelausführung socket version	Anschlussspannung connection voltage	Anschlussart connection type	Art.-Nr. Part No.
72 mm	SV8,5-36	12/24 V	Flachstecker 6,3mm Kabeldurchführung flat connector 6.3mm wire bushing	j13.4002.100

▪ **Universal
Kennzeichenleuchte**

▪ *universal
licence plate lamp*

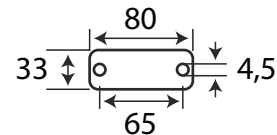

Lochabstand hole distance	Sockelausführung socket version	Anschlussspannung connection voltage	Anschlussart connection type	Art.-Nr. Part No.
65 mm	SV8,5-36	12/24 V	Flachstecker 6,3mm Kabeldurchführung flat connector 6.3mm wire bushing	098 254 180

Ⓔ



▪ **Universal
Kennzeichenleuchte**

▪ *universal
licence plate lamp*

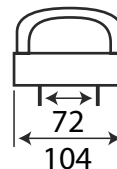
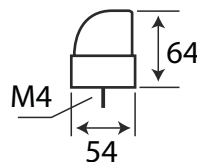

Lochabstand hole distance	Sockelausführung socket version	Anschlussspannung connection voltage	Anschlussart connection type	Art.-Nr. Part No.
72 mm	SV8,5-36	12/24 V	Flachstecker 6,3mm Kabeldurchführung flat connector 6.3mm wire bushing	j13.4002.110



E



▪ **Universal
Kennzeichenleuchte**

▪ *universal
licence plate lamp*

HECKBELEUCHTUNG
REAR LIGHTS

Lochabstand <i>hole distance</i>	Sockelausführung <i>socket version</i>	Anschlussspannung <i>connection voltage</i>	Anschlussart <i>connection type</i>	Art.-Nr. <i>Part No.</i>
45 mm	BA15s	12/24 V	Flachstecker 6,3mm Kabeldurchführung flat connector 6.3mm wire bushing	098 254 166

RÜCKFAHRSCHEINWERFER

REVERSE LAMPS



Ⓔ



▪ **MB Evobus Neoman**
Rückfahrscleinwerfer

▪ **MB Evobus Neoman**
reverse lamp

Sockelausführung socket version	Anschlussspannung connection voltage	OE- Nr. OE- No.	Kabellänge cable length	Leuchtmittel illuminant	Art.-Nr. Part No.
BA15s	12/24 V	2 Z2 008 805-041 2 Z2 008 805-047	200 mm		098 256 044
	24 V		200 mm	LED	098 256 054

Ⓔ



▪ **MB 0305 / 402 / 405 / 407 / 408**
MAN, Kässbohrer, Neoplan,
Steyr Bus
Rückfahrscleinwerfer

▪ **MB 0305 / 402 / 405 / 407 / 408**
MAN, Kässbohrer, Neoplan,
Steyr Bus
reverse lamp

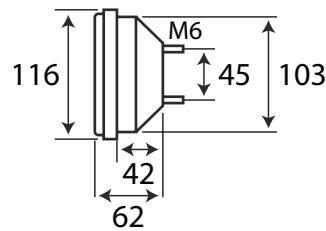

Sockelausführung socket version	Anschlussspannung connection voltage	Anschlussart connection type	OE- Nr. OE- No.	Art.-Nr. Part No.
BA15s	12/24 V	Flachstecker 6,3mm flat connector 6.3mm	2 Z2 003 236-051 2 Z2 003 236-057 2 Z2 003 236-311	098 255 056

Zusatzartikel

Produktart product type	Artikeltitel article title	OE- Nr. OE- No.	Art.-Nr. Part No.
Lichtscheiben lens	Lichtscheibe lens	QEL 119 544-111	098 290 056



HECKBELEUCHTUNG
REAR LIGHTS

Ⓔ



- Neoplan, Scania Citybus, Volvo Citybus Rückfahrcheinwerfer
- Neoplan, Scania Citybus, Volvo Citybus reverse lamp

Sockelausführung socket version	Anschlussspannung connection voltage	OE- Nr. OE- No.	Art.-Nr. Part No.
BA15s	12/24 V	2 Z2 005 603-061	098 257 034

Ⓔ



- Universal Rückfahrcheinwerfer
- universal reverse lamp

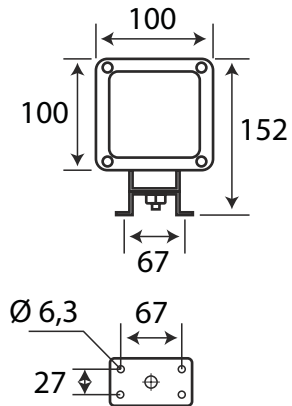
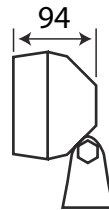

Höhe height	Breite width	Befestigungsart mounting	Anschlussspannung connection voltage	Anschlussart connection type	OE- Nr. OE- No.	Leuchtmittel illuminant	Art.-Nr. Part No.
152 mm	100 mm	Schraube M8 fixing screw M8	12/24 V	Flachstecker 6,3mm Flachstecker 6,3mm flat connector 6.3mm flat connector 6.3mm	2 Z8 997 506-391	Halogen	098 256 200

Zusatzartikel

Artikeltitlel article title	Art.-Nr. Part No.
Befestigungsbügel mounting bracket	098 192 972
Gummitülle rubber bushing	098 193 958

Ⓔ



▪ **Universal Rückfahrscheinwerfer**

▪ *universal reverse lamp*

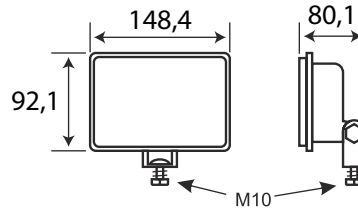

Höhe height	Breite width	Lichtstrom luminous lux	Befestigungsart mounting	Stromstärke amperage	Anschlussspannung connection voltage	Kabellänge cable length	Leuchtmittel illuminant	Art.-Nr. Part No.
92.1 mm	148.4 mm	390 lm	Schraubenbefestigung fitted with screw	0,4 A 0,4	24 V	400 mm	LED	098 256 214

Ⓔ



▪ **Universal Rückfahrscheinwerfer**

▪ *universal reverse lamp*

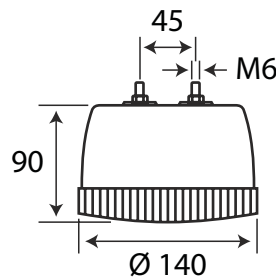

Sockelausführung socket version	Anschlussspannung connection voltage	Anschlussart connection type	OE- Nr. OE- No.	Art.-Nr. Part No.
BA15s	12/24 V	Flachstecker 6,3mm flat connector 6.3mm	2 Z2 001 423-001 2 Z2 001 423-011	098 256 040



Ⓔ



▪ **Universal Rückfahrcheinwerfer**

Anbauversion

▪ **universal reverse lamp**

Built-on version

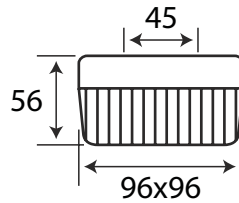

Sockelausführung socket version	Anschlussspannung connection voltage	Anschlussart connection type	Art.-Nr. Part No.
BA15s	12/24 V	Flachstecker 6,3mm flat connector 6.3mm	098 256 034

Ⓔ



▪ **Universal Rückfahrcheinwerfer**

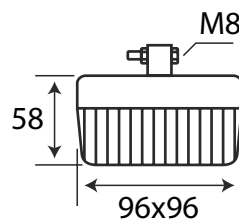

▪ **universal reverse lamp**

Befestigungsart mounting	Sockelausführung socket version	Anschlussspannung connection voltage	Anschlussart connection type	Art.-Nr. Part No.
Befestigungsbügel mounting bracket	BA15s	12/24 V	Flachstecker 6,3mm flat connector 6.3mm	098 256 036

Ⓔ



▪ **Universal Rückfahrcheinwerfer**

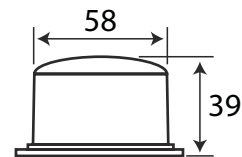
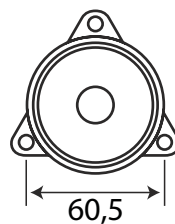

▪ **universal reverse lamp**

Anschlussspannung connection voltage	Leuchtmittel illuminant	Art.-Nr. Part No.
12 V	LED	098 256 512
24 V	LED	098 256 524

Ⓔ



▪ **Universal Rückfahrcheinwerfer**

▪ *universal reverse lamp*

Anschlussspannung <i>connection voltage</i>	Kabellänge <i>cable length</i>	Leuchtmittel <i>illuminant</i>	Art.-Nr. <i>Part No.</i>
24 V	500 mm	LED	098 256 074
12 V	500 mm	LED	098 256 072

Ⓔ



▪ **Universal Rückfahrcheinwerfer**

▪ *universal reverse lamp*

Anschlussspannung <i>connection voltage</i>	LED Anzahl <i>LED number</i>	Kabellänge <i>cable length</i>	Leuchtmittel <i>illuminant</i>	Art.-Nr. <i>Part No.</i>
12 V	38	500 mm	LED	098 256 172
24 V	38	500 mm	LED	098 256 174



Ⓔ



▪ **Universal Rückfahrcheinwerfer**

▪ *universal reverse lamp*

Anschlussspannung <i>connection voltage</i>	Anschlussart <i>connection type</i>	Leuchtmittel <i>illuminant</i>	Art.-Nr. <i>Part No.</i>
12 V	Kabeldurchführung wire bushing	LED	098 256 343
24 V	Kabeldurchführung wire bushing	LED	098 256 345

Zusatzartikel

Produktart <i>product type</i>	Artikeltitel <i>article title</i>	OE- Nr. <i>OE- No.</i>	Art.-Nr. <i>Part No.</i>
Montageteile mounting hardware	Einbauring installation ring	QXD 997 909-801	098 292 359

Ⓔ



▪ **Universal Rückfahrcheinwerfer**

▪ *universal reverse lamp*

Anschlussspannung <i>connection voltage</i>	Anschlussart <i>connection type</i>	Leuchtmittel <i>illuminant</i>	Art.-Nr. <i>Part No.</i>
9-33 V	Kabeldurchführung wire bushing	LED	098 256 309

Zusatzartikel

Artikeltitel <i>article title</i>	Art.-Nr. <i>Part No.</i>
Einbauring installation ring	098 292 369



▪ **Universal Rückfahrcheinwerfer**

▪ *universal reverse lamp*

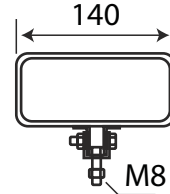
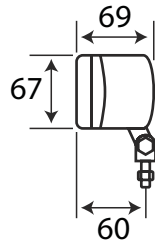

Befestigungsart <i>mounting</i>	Sockelausführung <i>socket version</i>	Anschlussspannung <i>connection voltage</i>	Anschlussart <i>connection type</i>	Glasfarbe <i>glass colour</i>	Art.-Nr. <i>Part No.</i>
Befestigungsbügel <i>mounting bracket</i>	BA15s	12/24 V	Flachstecker 6,3mm <i>flat connector 6.3mm</i>	weiß <i>white</i>	098 256 015

Ⓔ



▪ **Universal Rückfahrcheinwerfer**

▪ *universal reverse lamp*

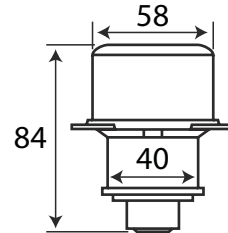
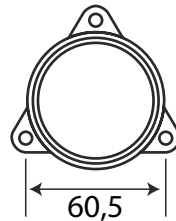

Sockelausführung <i>socket version</i>	Anschlussspannung <i>connection voltage</i>	OE- Nr. <i>OE- No.</i>	Art.-Nr. <i>Part No.</i>
BA15s	12/24 V	2 Z2 008 221-051 2 Z2 008 221-057	098 256 510



(E)

EMC



▪ Schwarz Müller
LED Rückfahrcheinwerfer

▪ Schwarz Müller
LED reverse lamp

Vibrationsfestigkeit <i>vibration proofed</i>	Höhe <i>height</i>	Breite <i>width</i>	Lichtstrom <i>luminous lux</i>	Stromstärke <i>ampere</i>	Anschlussspannung <i>connection voltage</i>	Anschlussart <i>connection type</i>	Kabellänge <i>cable length</i>	Leuchtmittel <i>illuminant</i>	Betriebstemperatur <i>temperature</i>	Art.-Nr. <i>Part No.</i>
15 g	156 mm	112 mm	1000 lm	0,91 A 0,91	10-48 V	Kabel wire	600 mm	LED	-40 bis 80	098 256 220
15 g	156 mm	112 mm	1000 lm	0,91 A 0,91	10-48 V	Stecker "Deutsch" connector "Deutsch"	600 mm	LED	-40 bis 80	098 256 221
15 g	156 mm	112 mm	1000 lm	0,91 A 0,91	10-48 V	AMP 1.5	600 mm	LED	-40 bis 80	098 256 222

(E)

EMC



▪ Schmitz Cargobull
LED Rückfahrcheinwerfer

▪ Schmitz Cargobull
LED reverse lamp

Höhe <i>height</i>	Lichtstrom <i>luminous lux</i>	Anschlussart <i>connection type</i>	Leuchtmittel <i>illuminant</i>	Art.-Nr. <i>Part No.</i>
164 mm	1000 lm	Kabel wire	LED	098 256 230
164 mm	1000 lm	Stecker "Deutsch" connector "Deutsch"	LED	098 256 231
164 mm	1000 lm	AMP 1.5	LED	098 256 232

NEBELSCHLUSSLEUCHTEN

REAR FOG LAMPS





HECKBELEUCHTUNG
REAR LIGHTS

Ⓔ



- **MB O305 / 402 / 405 / 407 / 408**
MAN, Kässbohrer und Neoplan,
Steyr Bus
Nebelschlussleuchte
- **MB O305 / 402 / 405 / 407 / 408**
MAN, Kässbohrer und Neoplan,
Steyr Bus
rear fog lamp

Sockelausführung socket version	Anschlussspannung connection voltage	Anschlussart connection type	OE- Nr. OE- No.	Art.-Nr. Part No.
BA15s	12/24 V	Flachstecker 6,3mm flat connector 6.3mm	2 NE 003 236-001	098 205 038

Zusatzartikel

Produktart product type	Artikeltitel article title	OE- Nr. OE- No.	Art.-Nr. Part No.
Lichtscheiben lens	Lichtscheibe lens	QEL 119 544-001	098 290 038

Ⓔ



- **Neoplan, Scania Citybus, Volvo Citybus**
Nebelschlussleuchte
- **Neoplan, Scania Citybus, Volvo Citybus**
rear fog lamp

Sockelausführung socket version	Anschlussspannung connection voltage	OE- Nr. OE- No.	Art.-Nr. Part No.
BA15s	12/24 V	2 NE 005 603-071	098 257 033

Ⓔ



- **Universal**
Nebelschlussleuchte
- **universal**
rear fog lamp

Sockelausführung socket version	Anschlussspannung connection voltage	Anschlussart connection type	OE- Nr. OE- No.	Art.-Nr. Part No.
BA15s	12/24 V	Flachstecker 6,3mm flat connector 6.3mm	2 NE 001 423-011	098 256 050

Ⓔ



▪ **Universal
Nebelschlussleuchte**

▪ *universal
rear fog lamp*

Anschlussspannung <i>connection voltage</i>	Leuchtmittel <i>illuminant</i>	Art.-Nr. <i>Part No.</i>
24 V	LED	098 257 524
12/24 V	LED	098 257 530

Ⓔ



▪ **Universal
Nebelschlussleuchte**

▪ *universal
rear fog lamp*

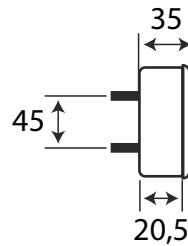
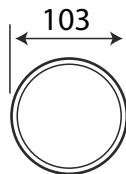

Anschlussspannung <i>connection voltage</i>	Anschlussart <i>connection type</i>	LED Anzahl <i>LED number</i>	Kabellänge <i>cable length</i>	Leuchtmittel <i>illuminant</i>	Art.-Nr. <i>Part No.</i>
12 V	Kabel wire	38	500 mm	LED	098 257 072
24 V	Kabel wire	38	500 mm	LED	098 257 074



(E)



▪ **Universal
Nebelschlussleuchte**

▪ *universal
rear fog lamp*

Anschlussspannung <i>connection voltage</i>	Anschlussart <i>connection type</i>	Leuchtmittel <i>illuminant</i>	Art.-Nr. <i>Part No.</i>
12 V	Kabeldurchführung wire bushing	LED	098 257 347
24 V	Kabeldurchführung wire bushing	LED	098 257 349

Zusatzartikel

Produktart <i>product type</i>	Artikeltitel <i>article title</i>	OE- Nr. <i>OE- No.</i>	Art.-Nr. <i>Part No.</i>
Montageteile mounting hardware	Einbauring installation ring	QXD 997 909-801	098 292 359

(E)



▪ **Universal
Nebelschlussleuchte**

▪ *universal
rear fog lamp*

Anschlussspannung <i>connection voltage</i>	Anschlussart <i>connection type</i>	Glasfarbe <i>glass colour</i>	Leuchtmittel <i>illuminant</i>	Art.-Nr. <i>Part No.</i>
9-33 V	Kabeldurchführung wire bushing	weiß white	LED	098 257 308
9-33 V	Kabeldurchführung wire bushing	rot red	LED	098 257 307

Zusatzartikel

Artikeltitel <i>article title</i>	Art.-Nr. <i>Part No.</i>
Einbauring installation ring	098 292 369

Ⓔ



▪ **Universal
 Nebelschlussleuchte**

▪ *universal
 rear fog lamp*

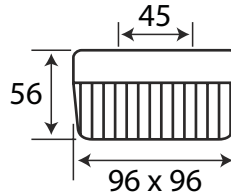

Sockelausführung <i>socket version</i>	Anschlussspannung <i>connection voltage</i>	Anschlussart <i>connection type</i>	OE- Nr. <i>OE- No.</i>	Art.-Nr. <i>Part No.</i>
BA15s	12/24 V	Flachstecker 6,3mm flat connector 6.3mm	2 NE 003 315-011	098 256 032



▪ **Universal
 Nebelschlussleuchte**

▪ *universal
 rear fog lamp*

Befestigungsart <i>mounting</i>	Sockelausführung <i>socket version</i>	Anschlussspannung <i>connection voltage</i>	Anschlussart <i>connection type</i>	Glasfarbe <i>glass colour</i>	Art.-Nr. <i>Part No.</i>
Befestigungsbügel mounting bracket	BA15s	12/24 V	Flachstecker 6,3mm flat connector 6.3mm	rot red	098 256 013

BREMSLEUCHTEN

STOP LAMPS





- MB 0305 / 402 / 405 / 407/ 408, MAN, Kässbohrer, Neoplan, Steyr Bus
Bremsleuchten
- MB 0305 / 402 / 405 / 407/ 408, MAN, Kässbohrer, Neoplan, Steyr Bus
stop lamp

Leuchtenfunktionen	lighting functions
Bremslicht	stoplight

Sockelausführung socket version	Anschlussspannung connection voltage	OE- Nr. OE- No.	Art.-Nr. Part No.
BA15s	12/24 V	2 DA 003 236-031 2 DA 003 236-331	098 205 088

Zusatzartikel

Produktart product type	Artikeltitel article title	OE- Nr. OE- No.	Art.-Nr. Part No.
Lichtscheiben lens	Lichtscheibe lens	QEL 119 544-031	098 290 088



- Neoplan, Scania Citybus, Volvo / Säffle Citybus
Bremsleuchten
- Neoplan, Scania Citybus, Volvo / Säffle Citybus
stop lamp

Leuchtenfunktionen	lighting functions
Bremslicht	stoplight

Sockelausführung socket version	Anschlussleistung connected load	Anschlussspannung connection voltage	OE- Nr. OE- No.	Art.-Nr. Part No.
BA15s	21 W	12/24 V	2 DA 005 603-031 2 DA 005 603-037	098 203 036



E

**Universal
Bremsleuchten****universal
stop lamp**

Einbauversion

*Built-in version***Leuchtenfunktionen****lighting functions**

Bremslicht

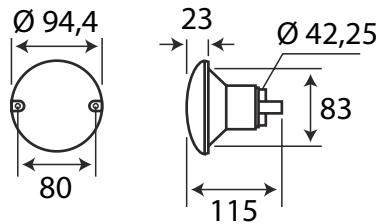
stoplight

Sockelausführung <i>socket version</i>	Anschlussspannung <i>connection voltage</i>	Art.-Nr. <i>Part No.</i>
BA15s	12/24 V	098 203 422

E

**Universal
Bremsleuchten****universal
stop lamp****Leuchtenfunktionen****lighting functions**

Bremslicht

stoplight

Sockelausführung <i>socket version</i>	Anschlussspannung <i>connection voltage</i>	Anschlussart <i>connection type</i>	Art.-Nr. <i>Part No.</i>
BA15s	12/24 V	Flachstecker 6,3mm flat connector 6.3mm	j13.3009.000

E

**Universal
Bremsleuchten****universal
stop lamp****Leuchtenfunktionen****lighting functions**

Bremslicht

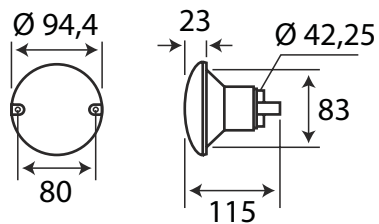
stoplight

Sockelausführung <i>socket version</i>	Anschlussspannung <i>connection voltage</i>	Art.-Nr. <i>Part No.</i>
BA15s	12/24 V	098 203 422

POSITIONSLEUCHTEN

POSITION LAMPS





Ⓔ



▪ **Universal
Positionsleuchte**

▪ **universal
Position lamp**

Leuchtenfunktionen

Positionslicht
Rückstrahler

lighting functions

position light
reflector

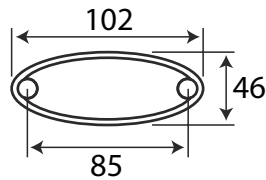

Anschlussspannung connection voltage	Anschlussart connection type	LED Anzahl LED number	Kabellänge cable length	Leuchtmittel illuminant	Art.-Nr. Part No.
12/24 V	Click-In	1	500 mm	LED	098 203 521

Ⓔ



▪ **Universal
Positionsleuchte**

▪ **universal
Position lamp**

Leuchtenfunktionen

Positionslicht
Rückstrahler

lighting functions

position light
reflector

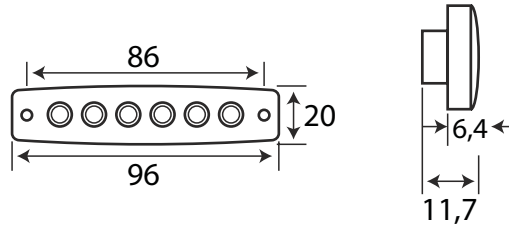

Anschlussspannung connection voltage	Anschlussart connection type	LED Anzahl LED number	Kabellänge cable length	Leuchtmittel illuminant	Art.-Nr. Part No.
12 V	Kabel wire	6	200 mm	LED	098 200 422
24 V	Kabel wire	6	200 mm	LED	098 200 424

Ⓔ



▪ **Universal
Positionsleuchte**

▪ **universal
Position lamp**

Leuchtenfunktionen

Positionslicht
Rückstrahler

lighting functions

position light
reflector

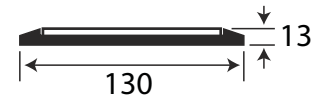
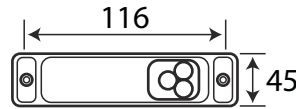

Anschlussspannung connection voltage	Anschlussart connection type	LED Anzahl LED number	Kabellänge cable length	Leuchtmittel illuminant	Art.-Nr. Part No.
12/24 V	Kabel wire	3	500 mm	LED	098 201 873
12/24 V	Kabel wire	3	5000 mm	LED	098 201 875

Ⓔ



▪ **Universal
Positionsleuchte**

▪ **universal
Position lamp**

Leuchtenfunktionen

Positionslicht
Rückstrahler

lighting functions

position light
reflector

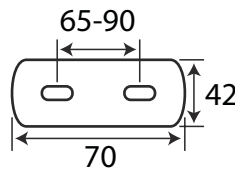

Anschlussleistung connected load	Anschlussspannung connection voltage	Anschlussart connection type	LED Anzahl LED number	Kabellänge cable length	Leuchtmittel illuminant	Art.-Nr. Part No.
1 W	9-33 V	Kabel wire	4	500 mm	LED	098 203 601
1 W	9-33 V	Kabel wire	4	5000 mm	LED	098 203 605



Ⓔ



▪ **Universal Positionslampe**

▪ *universal Position lamp*

Leuchtenfunktionen

Positionslicht

lighting functions

position light

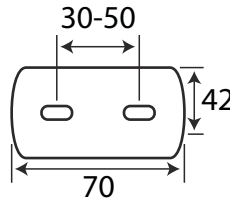

Anschlussleistung <i>connected load</i>	Anschlussspannung <i>connection voltage</i>	Anschlussart <i>connection type</i>	LED Anzahl <i>LED number</i>	Kabellänge <i>cable length</i>	Leuchtmittel <i>illuminant</i>	Art.-Nr. <i>Part No.</i>
1 W	9-33 V	Kabel wire	4	500 mm	LED	098 203 501
1 W	9-33 V	Kabel wire	4	5000 mm	LED	098 203 505

Ⓔ



▪ **Universal ER-X Fleximax Positionslampe**

▪ *universal ER-X Fleximax Position lamp*

Leuchtenfunktionen

Positionslicht
Rückstrahler

lighting functions

*position light
reflector*

Anschlussleistung <i>connected load</i>	Anschlussspannung <i>connection voltage</i>	Anschlussart <i>connection type</i>	LED Anzahl <i>LED number</i>	OE- Nr. <i>OE- No.</i>	Kabellänge <i>cable length</i>	Leuchtmittel <i>illuminant</i>	Art.-Nr. <i>Part No.</i>
1 W	9-33 V	Click-In	3	31.6309-007	500 mm	LED	098 203 400

Ⓔ



▪ **Universal Unipoint Positionslampe**

▪ *universal Unipoint Position lamp*

Leuchtenfunktionen

Positionslicht

lighting functions

position light

Anschlussleistung <i>connected load</i>	Anschlussspannung <i>connection voltage</i>	Anschlussart <i>connection type</i>	OE- Nr. <i>OE- No.</i>	Kabellänge <i>cable length</i>	Leuchtmittel <i>illuminant</i>	Art.-Nr. <i>Part No.</i>
1,3 W	24 V	Click-In	31.7804-017	500 mm	LED	098 221 512

Ⓔ



▪ **Universal
Positionsleuchte**

Montage horizontal oder vertikal

Leuchtenfunktionen

Positionslicht

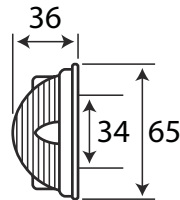

▪ **universal
Position lamp**

Horizontal – vertical mounting

lighting functions

position light

Sockelausführung socket version	Anschlussspannung connection voltage	Art.-Nr. Part No.
SV8,5-36	12/24 V	098 204 492

Zusatzartikel

Produktart product type	Artikeltitel article title	Art.-Nr. Part No.
Lichtscheiben lens	Lichtscheibe lens	098 294 498

Ⓔ



▪ **Universal
Positionsleuchte**

Positionslicht

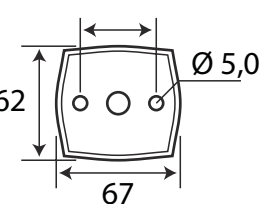

▪ **universal
Position lamp**

Leuchtenfunktionen

Positionslicht

lighting functions

position light

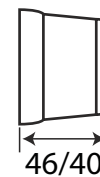

Sockelausführung socket version	Anschlussspannung connection voltage	Anschlussart connection type	OE- Nr. OE- No.	Art.-Nr. Part No.
SV8,5-36	12/24 V	Flachstecker 6,3mm flat connector 6.3mm	2 SA 003 057-021	098 200 975



▪ **Universal
Positionsleuchte**

Mit Chromring

Leuchtenfunktionen

Positionslicht

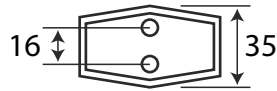

▪ **universal
Position lamp**

With chrome ring

lighting functions

position light

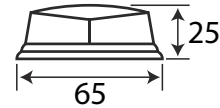

Sockelausführung socket version	Anschlussspannung connection voltage	Art.-Nr. Part No.
BA9s	12/24 V	098 208 402



▪ **Universal
Positionsleuchte**

Mit Chromring

Leuchtenfunktionen

Positionslicht

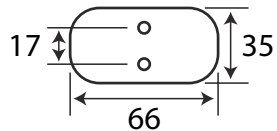

▪ **universal
Position lamp**

With chromering

lighting functions

position light

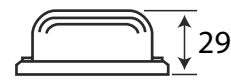

Sockelausführung socket version	Anschlussspannung connection voltage	Art.-Nr. Part No.
SV8,5-36	12/24 V	098 201 552



▪ **Universal
Positionsleuchte**

Leuchtenfunktionen

Positionslicht

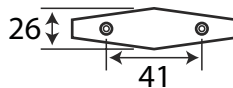

▪ **universal
Position lamp**

lighting functions

position light

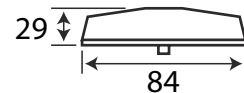

Sockelausführung socket version	Anschlussspannung connection voltage	Anschlussart connection type	Kabellänge cable length	Art.-Nr. Part No.
SV8,5-36	12/24 V	Kabel wire	500 mm	098 241 210

(E)



▪ **Universal
 Positionsleuchte**

▪ **universal
 Position lamp**

Leuchtenfunktionen

Positionslicht

lighting functions

position light

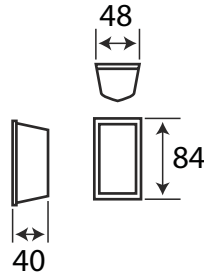

Sockelausführung socket version	Anschlussspannung connection voltage	Anschlussart connection type	Art.-Nr. Part No.
BA15s	12/24 V	Flachstecker 6,3mm flat connector 6.3mm	098 231 374

(E)



▪ **Universal
 Positionsleuchte**

▪ **universal
 Position lamp**

Leuchtenfunktionen

Positionslicht

Rückstrahler

lighting functions

position light

reflector

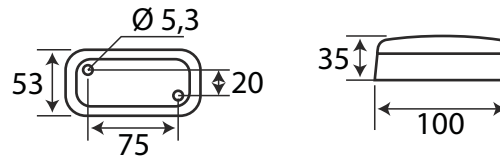

Sockelausführung socket version	Anschlussspannung connection voltage	Anschlussart connection type	Art.-Nr. Part No.
BA9s	12/24 V	Schraubanschluss PG7 screw connection PG7	098 201 393

Zusatzartikel

Produktart product type	Artikeltitel article title	Art.-Nr. Part No.
Lichtscheiben lens	Lichtscheibe lens	098 291 397



Ⓔ



▪ **Universal
Positionsleuchte**

▪ **universal
Position lamp**

Leuchtenfunktionen

Positionslicht
Rückstrahler

lighting functions

position light
reflector

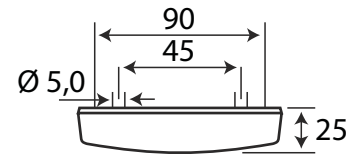
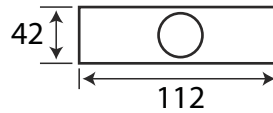

Sockelausführung socket version	Anschlussspannung connection voltage	Anschlussart connection type	OE- Nr. OE- No.	Art.-Nr. Part No.
BA9s	12/24 V	Flachstecker 6,3mm flat connector 6.3mm	2 SA 006 717-001 2 TM 006 717-047	098 200 291

Ⓔ



▪ **Universal
Positionsleuchte**

▪ **universal
Position lamp**

Mit Chromring

With chromering

Leuchtenfunktionen

Positionslicht

lighting functions

position light

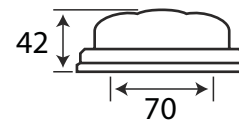
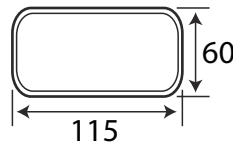

Sockelausführung socket version	Anschlussspannung connection voltage	Anschlussart connection type	Art.-Nr. Part No.
BA15s	12/24 V	Kabel wire	098 201 454

Zusatzartikel

Artikeltitle article title	Glasfarbe glass colour	Art.-Nr. Part No.
Lichtscheibe lens	rot red	098 291 458



▪ **Universal
Positionsleuchte**

Mit schwarzem Metallrahmen

Leuchtenfunktionen

Positionslicht

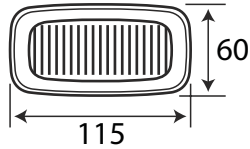

▪ **universal
Position lamp**

With black metal frame

lighting functions

position light

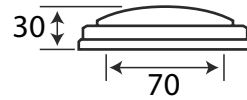

Sockelausführung socket version	Anschlussspannung connection voltage	Anschlussart connection type	Art.-Nr. Part No.
BA15s	12/24 V	Kabel wire	098 201 458

Zusatzartikel

Artikeltitlel article title	Art.-Nr. Part No.
Lichtscheibe lens	098 291 452

BELEUCHTUNGSSÄTZE

LIGHTING SETS



Ⓔ



▪ **Universal Beleuchtungssatz**

Einsatzbreite 2500 mm

Leuchtenfunktionen

Blinklicht
Bremslicht
Kennzeichenlicht
Schlusslicht

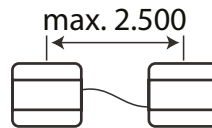

▪ **universal lighting set**

Width 2500 mm

lighting functions

indicator
stoplight
licence plate light
tail light

Zusätzl. Leuchtenfunktionen <i>add. lighting functions</i>	Befestigungsart <i>mounting</i>	Anschlussspannung <i>connection voltage</i>	Anschlussart <i>connection type</i>	Kabellänge <i>cable length</i>	Art.-Nr. <i>Part No.</i>
	Magnetbefestigung magnetic holder	12 V	Stecker 7-polig 7-pole connector	7500 mm	098 259 820
Rückstrahler Dreieck reflector triangular	Magnetbefestigung magnetic holder	12 V	Stecker 7-polig 7-pole connector	7500 mm	098 259 822

**INFORMIEREN SIE SICH
AUCH ÜBER UNSEREN
FAHRZEUGAUSRÜSTUNGSKATALOG**
WWW.RAL.AT





(E)



▪ **Universal Beleuchtungssatz**

▪ **universal lighting set**

Leuchtenfunktionen	lighting functions
Schlusslicht	tail light
Bremslicht	stoplight
Blinklicht	indicator
Kennzeichenlicht	licence plate light
Rückstrahler Dreieck	reflector triangular

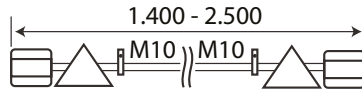

Anschlussspannung connection voltage	Anschlussart connection type	Kabellänge cable length	Art.-Nr. Part No.
12 V	Stecker 7-polig 7-pole connector	7500 mm	098 259 804

Zusatzartikel

Produktart product type	Artikeltitel article title	OE- Nr. OE- No.	Sockelausführung socket version	Anschlussart connection type	Zusätzl. Leuchtenfunktionen add. lighting functions	Art.-Nr. Part No.
	Stecker plug	0 352 170 001 0 352 170 002 0 352 170 003 0 352 170 005		Schraubklemmen screw terminals		090 147 714
Mehrkammerleuchte multi-chamber lights			BAY15d BA15s			098 210 360
Mehrkammerleuchte multi-chamber lights			BAY15d BA15s		Kennzeichenlicht licence plate light	098 210 361
Rückstrahler reflex reflector	Dreieck-Rückstrahler triangled reflex reflector					098 267 610
	Magnetbefestigung magnetic holder					098 299 809

SEITENMARKIERUNGSLAUCHTEN

SIDE MARKER LAMPS





Ⓔ



▪ DAF XF105, XC105 2006
Seitenmarkierungsleuchte

▪ DAF XF105, XC105 2006
side marker lamp

Leuchtenfunktionen

Seitenmarkierungslicht
Rückstrahler

lighting functions

side marker light
reflector

Anschlussleistung connected load	Anschlussspannung connection voltage	Anschlussart connection type	OE- Nr. OE- No.	Leuchtmittel illuminant	Art.-Nr. Part No.
3 W	24 V	AMP Superseal	169 7119	LED	098 221 397

Zusatzartikel

Produktart product type	Artikeltitel article title	Art.-Nr. Part No.
Stecker connector	KIT SUPER SEAL	099 110 019
	Schutzhülle protection cover	099 110 624

Ⓔ



▪ MAN F2000 4.96-2000
Seitenmarkierungsleuchte

▪ MAN F2000 4.96-2000
side marker lamp

Leuchtenfunktionen

Seitenmarkierungslicht
Rückstrahler

lighting functions

side marker light
reflector

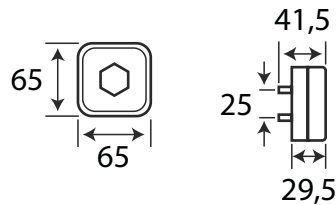

Anschlussspannung connection voltage	Anschlussart connection type	Glasfarbe glass colour	OE- Nr. OE- No.	Leuchtmittel illuminant	Art.-Nr. Part No.
24 V	Stecker connector	orange amber	81.25225.6498		098 221 370

Zusatzartikel

Produktart product type	Artikeltitel article title	Art.-Nr. Part No.
Fassungen bulb holder	Fassung mit Anschlusskabel bulb holder with connection wire	098 291 375
Lichtscheiben lens	Lichtscheibe lens	098 291 372



▪ **MAN F2000 > 2000**
Seitenmarkierungsleuchte

▪ **MAN F2000 > 2000**
side marker lamp

Leuchtenfunktionen
 Seitenmarkierungslicht

lighting functions
 side marker light

Anschlussspannung connection voltage	Anschlussart connection type	Glasfarbe glass colour	OE- Nr. OE- No.	Kabellänge cable length	Art.-Nr. Part No.
24 V	AMP 1.5	orange amber	81.25225-6498 81.25225-6503 81.25260-6080	1500 mm	098 221 376

Zusatzartikel

Produktart product type	Artikeltitel article title	Art.-Nr. Part No.
Fassungen bulb holder	Fassung mit Anschlusskabel bulb holder with connection wire	098 291 375
Lichtscheiben lens	Lichtscheibe lens	098 291 372
Stecker connector	KIT MAN NW 4,5-8,5	099 111 410
Stecker connector	KIT MAN NW 4,5-8,5	099 111 439



▪ **Scania 4**
Seitenmarkierungsleuchte

▪ **Scania 4**
side marker lamp

Leuchtenfunktionen
 Seitenmarkierungslicht

lighting functions
 side marker light

Anschlussspannung connection voltage	Anschlussart connection type	LED Anzahl LED number	Glasfarbe glass colour	OE- Nr. OE- No.	Kabellänge cable length	Leuchtmittel illuminant	Art.-Nr. Part No.
24 V	Kabel wire	4	orange amber	1471599 1391144	1500 mm	LED	098 221 245



Ⓔ



▪ **MB Actros I**
Seitenmarkierungsleuchte

▪ **MB Actros I**
side marker lamp

Leuchtenfunktionen

Seitenmarkierungslicht
Rückstrahler

lighting functions

side marker light
reflector

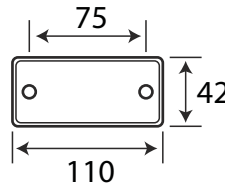

Anschlussleistung connected load	Anschlussspannung connection voltage	Anschlussart connection type	Glasfarbe glass colour	OE- Nr. OE- No.	Art.-Nr. Part No.
3 W	24 V	AMP 1.5	orange amber	000 544 4111	098 221 225

Zusatzartikel

Produktart product type	Artikeltitel article title	Anbauwinkel mounting bracket	Art.-Nr. Part No.
	Montagerahmen holder	90	098 293 309
Stecker connector	KIT JPT 2PK1		099 110 006

BEACHTEN SIE UNSERE
LAUFENDEN AKTIONEN
IN UNSEREN FILIALEN
UND AUF
WWW.RAL.AT





▪ **MB Actros II**
Seitenmarkierungsleuchte

▪ **MB Actros II**
side marker lamp

Leuchtenfunktionen

Seitenmarkierungslicht
Rückstrahler

lighting functions

side marker light
reflector

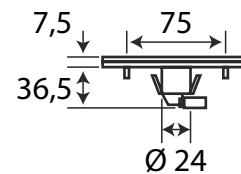
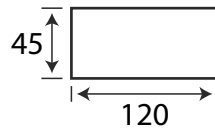

Anschlussleistung connected load	Anschlussspannung connection voltage	Anschlussart connection type	LED Anzahl LED number	Glasfarbe glass colour	OE- Nr. OE- No.	Kabel- länge cable length	Leucht- mittel illuminant	Art.-Nr. Part No.
	24 V	Stecker connector	6	orange amber	000 544 5411 000 544 5211 000 544 7211		LED	198 221 357
	24 V	Kabel wire	6	orange amber	000 544 5411 000 544 5211	500 mm	LED	098 221 357
3 W	24 V	AMP 1.5		orange amber	000 544 4111			098 221 225

Zusatzartikel

Artikeltitel article title	Anbauwinkel mounting bracket	Art.-Nr. Part No.
Montagerahmen holder	90	098 293 309



▪ **MB Actros III/IV**
Seitenmarkierungsleuchte

▪ **MB Actros III/IV**
side marker lamp

Leuchtenfunktionen	lighting functions
Seitenmarkierungslicht Rückstrahler	side marker light reflector

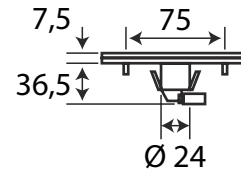
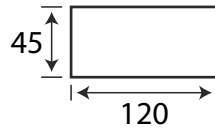

Anschlussspannung connection voltage	Anschlussart connection type	LED Anzahl LED number	Glasfarbe glass colour	OE- Nr. OE- No.	Kabellänge cable length	Leuchtmittel illuminant	Art.-Nr. Part No.
24 V	Stecker connector	6	orange amber	000 544 5411 000 544 5211 000 544 7211		LED	198 221 357
24 V	Kabel wire	6	orange amber	000 544 5411 000 544 5211	500 mm	LED	098 221 357

Zusatzartikel

Produktart product type	Artikeltitel article title	Art.-Nr. Part No.
Stecker connector	KIT MB Actros, Atego	099 111 116



▪ **MB Evo Bus**
Seitenmarkierungsleuchte

▪ **MB Evo Bus**
side marker lamp

Leuchtenfunktionen	lighting functions
Seitenmarkierungslicht Rückstrahler	side marker light reflector

Anschlussart connection type	LED Anzahl LED number	Glasfarbe glass colour	OE- Nr. OE- No.	Kabellänge cable length	Leuchtmittel illuminant	Art.-Nr. Part No.
Kabel wire	3	orange amber	000 544 4911	40 mm	LED	910 221 827

Zusatzartikel

Produktart product type	Artikeltitel article title	Art.-Nr. Part No.
Stecker connector	Stecker connector	099 110 010

Ⓔ



▪ **MAN Universal
 Seitenmarkierungsleuchte**

▪ **MAN Universal
 side marker lamp**

Leuchtenfunktionen

Seitenmarkierungslicht
 Rückstrahler

lighting functions

side marker light
 reflector

Anschlussspannung connection voltage	Leuchtmittel illuminant	Art.-Nr. Part No.
24 V	LED	098 221 372

Ⓔ



▪ **MAN TGA-A / TG-L / TG-M / LE
 2000
 Seitenmarkierungsleuchte**

▪ **MAN TGA-A / TG-L / TG-M / LE
 2000
 side marker lamp**

Leuchtenfunktionen

Seitenmarkierungslicht
 Rückstrahler

lighting functions

side marker light
 reflector

Anschlussart connection type	OE- Nr. OE- No.	Kabellänge cable length	Leuchtmittel illuminant	Art.-Nr. Part No.
AMP-M Kabel mit Stecker AMP-M wire with connector	81.25260-6097	1200 mm	LED	098 221 701
AMP-W Kabel mit Stecker AMP-W wire with connector	81.25260-6084 81.25260-6104 81.25260-6084	1500 mm	LED	098 221 704
AMP-M Kabel mit Stecker AMP-M wire with connector	81.25260-6105	1500 mm	LED	098 221 705

Zusatzartikel

Produktart product type	Artikeltitel article title	Art.-Nr. Part No.
Stecker connector	KIT MAN NW 4,5-8,5	099 111 439
Stecker connector	KIT MAN NW 4,5-8,5	099 111 410



▪ **MAN Bus**
Seitenmarkierungsleuchte

▪ **MAN Bus**
side marker lamp

Leuchtenfunktionen

Seitenmarkierungslicht
Rückstrahler

lighting functions

side marker light
reflector

Anschlussart connection type	LED Anzahl LED number	Glasfarbe glass colour	OE- Nr. OE- No.	Kabellänge cable length	Leuchtmittel illuminant	Art.-Nr. Part No.
AMP 1.5	1	orange amber	81.25260-6095	80 mm	LED	910 221 826

Zusatzartikel

Produktart product type	Artikeltitel article title	Art.-Nr. Part No.
Stecker connector	KIT JPT 2PK1	099 110 006



▪ **Kögel**
Seitenmarkierungsleuchte

▪ **Kögel**
side marker lamp

Leuchtenfunktionen

Seitenmarkierungslicht
Rückstrahler

lighting functions

side marker light
reflector

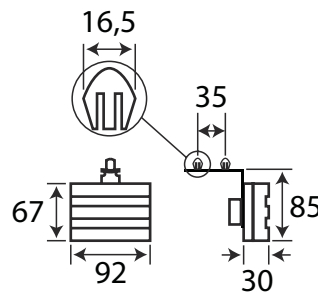

Sockelausführung socket version	Anschlussspannung connection voltage	Anschlussart connection type	LED Anzahl LED number	Glasfarbe glass colour	OE- Nr. OE- No.	Leuchtmittel illuminant	Art.-Nr. Part No.
SV8,5-36	24 V	Flachstecker 6,3mm flat connector 6.3mm		orange amber	2PS 340 000-021 2PS 340 000-027		098 221 290
	24 V	Click-In	2	orange amber		LED	098 221 295



▪ Volvo FM/FH II, FM/FH III
 Seitenmarkierungsleuchte

▪ Volvo FM/FH II, FM/FH III
 side marker lamp

Leuchtenfunktionen

Seitenmarkierungslicht
 Rückstrahler

lighting functions

side marker light
 reflector

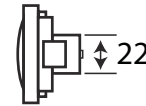
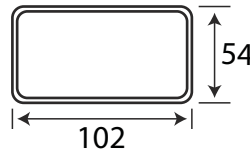

Anschlussspannung connection voltage	Anschlussart connection type	LED Anzahl LED number	Glasfarbe glass colour	OE- Nr. OE- No.	Leuchtmittel illuminant	Produktlinie product line	Art.-Nr. Part No.
24 V	Stecker connector	4	orange amber	20789440 20398660	LED	Premium	098 221 265
24 V	Stecker connector	4	orange amber	20789440 20398660	LED	Eco	198 221 265

Zusatzartikel

Produktart product type	Artikeltitel article title	OE- Nr. OE- No.	Art.-Nr. Part No.
Anschlusskabel connection wire	Anschlusskabel Upgrade auf LED connection wire upgrade to LED	85105029	098 291 266
Stecker connector	KIT Scania NW 7,5		099 110 635



▪ DAF, Iveco, Renault, Volvo
Seitenmarkierungsleuchte

▪ DAF, Iveco, Renault, Volvo
side marker lamp

Leuchtenfunktionen

Seitenmarkierungslicht
Rückstrahler

lighting functions

side marker light
reflector

Anschlussleistung connected load	Anschlussspannung connection voltage	Anschlussart connection type	LED Anzahl LED number	Glasfarbe glass colour	OE- Nr. OE- No.	Leuchtmittel illuminant	Produktlinie product line	Art.-Nr. Part No.
3 W	24 V	Stecker connector	4	orange amber	500 308 514 20734485 1329718	LED	Premium	098 221 381
3 W	24 V	Stecker connector	4	orange amber	500 308 514 20734485 1329718	LED	Eco	198 221 381

Zusatzartikel

Produktart product type	Artikeltitel article title	OE- Nr. OE- No.	Art.-Nr. Part No.
Fassungen bulb holder	Fassung bulb holder	160 33 52 500 184 7589	098 291 381
Stecker connector	KIT JPT 2PK1 NW 10 Renault		099 110 741



▪ Volvo FH/FM, Scania P/G/R > 04
Seitenmarkierungsleuchte

▪ Volvo FH/FM, Scania P/G/R > 04
side marker lamp

Leuchtenfunktionen

Seitenmarkierungslicht
Rückstrahler

lighting functions

side marker light
reflector

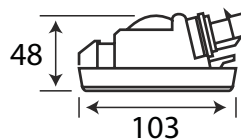

Anschlussspannung connection voltage	Anschlussart connection type	Glasfarbe glass colour	Art.-Nr. Part No.
24 V	AMP 1.5	orange amber	098 221 377

Zusatzartikel

Produktart product type	Artikeltitel article title	Art.-Nr. Part No.
Fassungen bulb holder	Fassung bulb holder	098 291 378
Stecker connector	KIT SUPER SEAL	099 110 019



▪ **Universal LED**
Seitenmarkierungsleuchte

▪ **universal**
side marker lamp

Leuchtenfunktionen

Seitenmarkierungslicht
Rückstrahler

lighting functions

side marker light
reflector

Anschlussspannung connection voltage	Anschlussart connection type	LED Anzahl LED number	Glasfarbe glass colour	Kabellänge cable length	Leuchtmittel illuminant	Art.-Nr. Part No.
9-33 V	Kabel wire	4	orange amber	500 mm	LED	098 221 601
9-33 V	Kabel wire	4	orange amber	5000 mm	LED	098 221 605



▪ **Universal LED "ER-X Fleximax"**
Seitenmarkierungsleuchte

▪ **universal LED "ER-X Fleximax"**
side marker lamp

Leuchtenfunktionen

Seitenmarkierungslicht
Rückstrahler

lighting functions

side marker light
reflector

Anschlussspannung connection voltage	Anschlussart connection type	LED Anzahl LED number	Glasfarbe glass colour	Kabellänge cable length	Leuchtmittel illuminant	Art.-Nr. Part No.
9-33 V	Click-In	3	orange amber	500 mm	LED	098 221 400



▪ **Universal LED**
Seitenmarkierungsleuchte

▪ **universal LED**
side marker lamp

Leuchtenfunktionen

Seitenmarkierungslicht
Rückstrahler

lighting functions

side marker light
reflector

Befesti- gungsart mounting	Anbauwinkel mounting bracket	Anschlussspan- nung connection voltage	Anschlussart connection type	LED Anzahl LED number	Glas- farbe glass colour	OE- Nr. OE- No.	Kabel- länge cable length	Leucht- mittel illuminant	Art.-Nr. Part No.
Anbauwinkel mounting bracket	90 °	24 V	Click-In	1	orange amber	31-2714- 007 31-2214- 007	500 mm	LED	098 221 216



▪ **Universal LED**
Seitenmarkierungsleuchte

▪ *universal LED*
side marker lamp

Leuchtenfunktionen	lighting functions
Seitenmarkierungslicht Rückstrahler	side marker light reflector

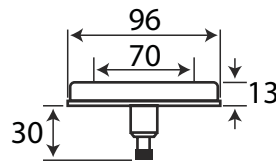

Anschlussspannung connection voltage	Anschlussart connection type	LED Anzahl LED number	Glasfarbe glass colour	Leuchtmittel illuminant	Art.-Nr. Part No.
24 V	Anschluss gerade connection straight	3	orange amber	LED	098 221 209
24 V	Anschluss rechtwinkelig connection right angled	3	orange amber	LED	098 221 211
24 V	Anschluss rechtwinkelig 2 Seitig connection right angled 2 sides	3	orange amber	LED	40 157 001



▪ **Universal LED**
Seitenmarkierungsleuchte

▪ *universal LED*
side marker lamp

Leuchtenfunktionen	lighting functions
Seitenmarkierungslicht Rückstrahler	side marker light reflector

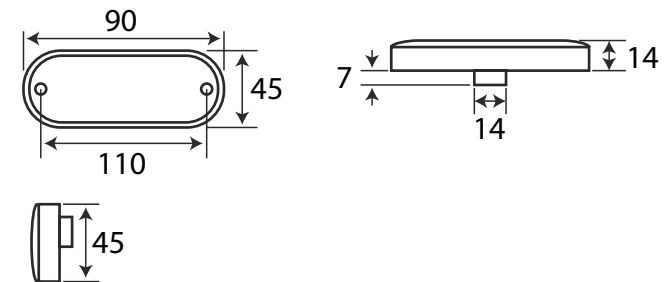

Anschlussleistung connected load	Anschlussspannung connection voltage	Anschlussart connection type	LED Anzahl LED number	Glasfarbe glass colour	Kabellänge cable length	Leuchtmittel illuminant	Art.-Nr. Part No.
0.6 W	12 V	Flachstecker 6,3mm flat connector 6.3mm	3	orange amber		LED	j12.1009.000
0.6 W	12 V	Kabel wire	3	orange amber	100 mm	LED	j12.1008.100
1.2 W	24 V	Kabel wire	3	orange amber	165 mm	LED	j12.1010.150
0.6 W	12 V	Kabel wire	3	orange amber	500 mm	LED	j12.1008.805
1.2 W	24 V	Kabel wire	3	orange amber	500 mm	LED	j12.1010.805



▪ **Universal LED**
Seitenmarkierungsleuchte

▪ **universal LED**
side marker lamp

Leuchtenfunktionen

Seitenmarkierungslicht
Rückstrahler

lighting functions

side marker light
reflector

Anschlussleistung connected load	Anschlussspannung connection voltage	Anschlussart connection type	LED Anzahl LED number	Glasfarbe glass colour	OE- Nr. OE- No.	Leuchtmittel illuminant	Art.-Nr. Part No.
1.2 W	24 V	JPT	4	orange amber	11170068	LED	098 221 250

Zusatzartikel

Produktart product type	Artikeltitel article title	Kabellänge cable length	Art.-Nr. Part No.
Anschlusskabel connection wire	Reparatursätze Steckverbindungen repair kits for plugs	2000 mm	098 291 230



▪ **Universal LED**
Seitenmarkierungsleuchte

▪ **universal LED**
side marker lamp

Leuchtenfunktionen

Seitenmarkierungslicht
Rückstrahler

lighting functions

side marker light
reflector

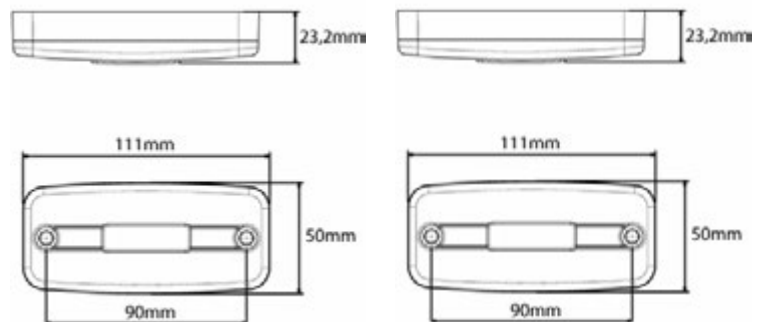

Anschlussleistung connected load	Anschlussspannung connection voltage	Anschlussart connection type	LED Anzahl LED number	Glasfarbe glass colour	Kabellänge cable length	Leuchtmittel illuminant	Art.-Nr. Part No.
0,4/0,8 W	12/24 V	Kabel wire	3	orange amber	500 mm	LED	098 221 940
0,4/0,8 W	12/24 V	Kabel wire	3	orange amber	5000 mm	LED	098 221 941
0,4/0,8 W	12/24 V	Kabel wire	3	orange amber	10000 mm	LED	098 221 944

Zusatzartikel

Produktart product type	Artikeltitel article title	OE- Nr. OE- No.	Art.-Nr. Part No.
Montagehardware mounting hardware	Anbauwinkel mounting bracket	TA 342 120-010	098 291 949



▪ **Universal LED
Seitenmarkierungsleuchte**

▪ **universal LED
side marker lamp**

Leuchtenfunktionen	lighting functions
Seitenmarkierungslicht Rückstrahler	side marker light reflector

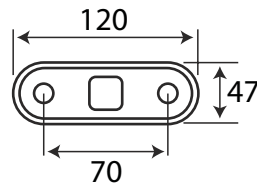

Befestigungsart mounting	Anbauwinkel mounting bracket	Anschlussspannung connection voltage	Anschlussart connection type	LED Anzahl LED number	Glasfarbe glass colour	Kabellänge cable length	Leuchtmittel illuminant	Art.-Nr. Part No.
		24 V	Click-In	1	orange amber	1500 mm	LED	098 221 500
Anbauwinkel mounting bracket	90 °	12/24 V	Click-In	1	orange amber	500 mm	LED	098 221 501
Anbauwinkel mounting bracket	90 °	12/24 V	Click-In	1	orange amber	1500 mm	LED	098 221 502



▪ **Universal LED
Seitenmarkierungsleuchte**

▪ **universal LED
side marker lamp**

Leuchtenfunktionen	lighting functions
Seitenmarkierungslicht Rückstrahler	side marker light reflector

Anschlussspannung connection voltage	Anschlussart connection type	LED Anzahl LED number	Glasfarbe glass colour	Kabellänge cable length	Leuchtmittel illuminant	Art.-Nr. Part No.
12/24 V	Click-In	1	orange amber	1500 mm	LED	098 221 525



▪ **Universal LED**
Seitenmarkierungsleuchte

▪ *universal LED*
side marker lamp

Leuchtenfunktionen
Seitenmarkierungslicht
Rückstrahler

lighting functions
side marker light
reflector

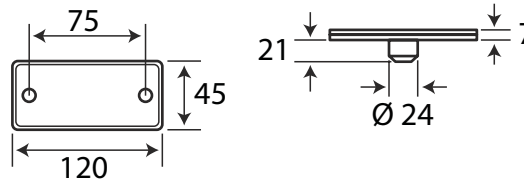

Anschlussleistung <i>connected load</i>	Anschlussspannung <i>connection voltage</i>	Anschlussart <i>connection type</i>	LED Anzahl <i>LED number</i>	Glasfarbe <i>glass colour</i>	Kabellänge <i>cable length</i>	Leuchtmittel <i>illuminant</i>	Art.-Nr. <i>Part No.</i>
0,7/1,5 W	12/24 V	Kabel wire	1	orange amber	300 mm	LED	098 221 354

Zusatzartikel

Artikeltitle <i>article title</i>	Anbauwinkel <i>mounting bracket</i>	Art.-Nr. <i>Part No.</i>
Montagerahmen holder	90	098 293 309



▪ **Universal LED**
Seitenmarkierungsleuchte

▪ *universal LED*
side marker lamp

Leuchtenfunktionen
Seitenmarkierungslicht
Rückstrahler

lighting functions
side marker light
reflector

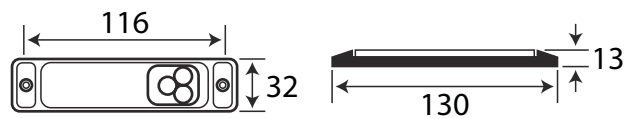

Befestigungsart <i>mounting</i>	Anbauwinkel <i>mounting bracket</i>	Anschlussspannung <i>connection voltage</i>	Anschlussart <i>connection type</i>	LED Anzahl <i>LED number</i>	Glasfarbe <i>glass colour</i>	Kabellänge <i>cable length</i>	Leuchtmittel <i>illuminant</i>	Art.-Nr. <i>Part No.</i>
horizontal		12/24 V	Kabel wire	3	orange amber	1500 mm	LED	098 221 874
horizontal		12/24 V	Kabel wire	3	orange amber	5000 mm	LED	098 221 876
vertikal vertical		12/24 V	Kabel wire	3	orange amber	1500 mm	LED	098 221 884
vertikal vertical		12/24 V	Kabel wire	3	orange amber	10000 mm	LED	098 221 896
Anbauwinkel mounting bracket	90 °	12/24 V	Kabel wire	3	orange amber	500 mm	LED	098 221 228

Zusatzartikel

Produktart <i>product type</i>	Artikeltitle <i>article title</i>	Anbauwinkel <i>mounting bracket</i>	Art.-Nr. <i>Part No.</i>
Montageteile mounting hardware	Winkelhalter mounting bracket	90	098 291 278



▪ **Universal LED**
Seitenmarkierungsleuchte

▪ **universal LED**
side marker lamp

Leuchtenfunktionen

Seitenmarkierungslicht
Rückstrahler

lighting functions

side marker light
reflector

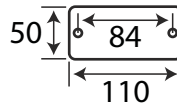

Anschlussspannung connection voltage	Anschlussart connection type	LED Anzahl LED number	Glasfarbe glass colour	Leuchtmittel illuminant	Art.-Nr. Part No.
12/24 V	AMP 1.5	2	orange amber	LED	098 221 850

Zusatzartikel

Produktart product type	Artikeltitel article title	Kabellänge cable length	Art.-Nr. Part No.
Anschlusskabel connection wire	Reparatursätze Steckverbindungen repair kits for plugs	2000 mm	098 291 230



▪ **Universal LED**
Seitenmarkierungsleuchte

▪ **universal LED**
side marker lamp

Leuchtenfunktionen

Seitenmarkierungslicht
Rückstrahler

lighting functions

side marker light
reflector

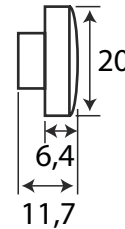
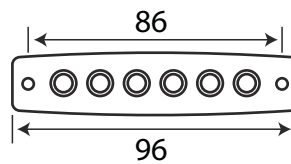

Anschlussspannung connection voltage	Anschlussart connection type	LED Anzahl LED number	Glasfarbe glass colour	Kabellänge cable length	Leuchtmittel illuminant	Art.-Nr. Part No.
12 V	Kabel wire	6	orange amber	200 mm	LED	098 221 422
24 V	Kabel wire	6	orange amber	200 mm	LED	098 221 424



▪ **Universal**
Seitenmarkierungsleuchte

▪ **universal**
side marker lamp

Leuchtenfunktionen

Seitenmarkierungslicht
 Rückstrahler

lighting functions

side marker light
 reflector

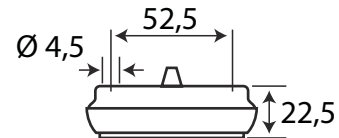
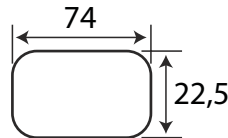

Anschlussspannung connection voltage	Anschlussart connection type	Glasfarbe glass colour	Leuchtmittel illuminant	Art.-Nr. Part No.
12/24 V	Flachstecker 6,3mm flat connector 6.3mm	orange amber		j12.1004.001



▪ **Universal**
Seitenmarkierungsleuchte

▪ **universal**
side marker lamp

Leuchtenfunktionen

Seitenmarkierungslicht
 Rückstrahler

lighting functions

side marker light
 reflector

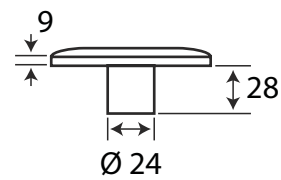
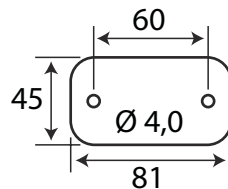

Anschlussspannung connection voltage	Anschlussart connection type	Glasfarbe glass colour	Art.-Nr. Part No.
12/24 V	Flachstecker 6,3mm flat connector 6.3mm	orange amber	098 221 204

Zusatzartikel

Produktart product type	Artikeltitel article title	Anschlussart connection type	Art.-Nr. Part No.
Fassungen bulb holder	Fassung bulb holder	Flachstecker 6,3mm flat connector 6.3mm	098 291 205



▪ **Universal**
Seitenmarkierungsleuchte

▪ *universal*
side marker lamp

Leuchtenfunktionen

Seitenmarkierungslicht
Rückstrahler

lighting functions

side marker light
reflector

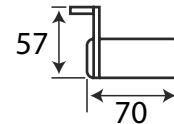
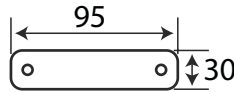

Befestigungsart <i>mounting</i>	Anbauwinkel <i>mounting bracket</i>	Anschlussspannung <i>connection voltage</i>	Anschlussart <i>connection type</i>	Glasfarbe <i>glass colour</i>	Art.-Nr. <i>Part No.</i>
		12/24 V	Flachstecker 6,3mm flat connector 6.3mm	orange amber	098 221 213
Anbauwinkel mounting bracket	90 °	12/24 V	Flachstecker 6,3mm flat connector 6.3mm	orange amber	098 221 212

Zusatzartikel

Produktart <i>product type</i>	Artikeltitel <i>article title</i>	OE- Nr. <i>OE- No.</i>	Art.-Nr. <i>Part No.</i>
Fassungen bulb holder	Fassung bulb holder	15 2128 524	098 296 225
Lichtscheiben lens	Lichtscheibe lens		098 291 211



▪ **Universal**
Seitenmarkierungsleuchte

▪ *universal*
side marker lamp

Leuchtenfunktionen

Seitenmarkierungslicht
Rückstrahler

lighting functions

side marker light
reflector

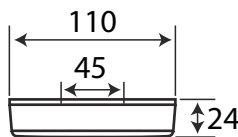

Farbe <i>colour</i>	Stromstärke <i>amperage</i>	Anschlussart <i>connection type</i>	Art.-Nr. <i>Part No.</i>
orange amber	12/24 A	Flachstecker 6,3mm flat connector 6.3mm	098 221 391

Ⓔ



▪ **Universal**
Seitenmarkierungsleuchte

▪ **universal**
side marker lamp

Leuchtenfunktionen

Seitenmarkierungslicht
Rückstrahler

lighting functions

side marker light
reflector

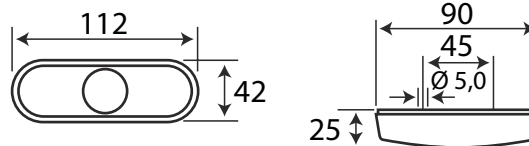

Anschlussleistung <i>connected load</i>	Anschlussspannung <i>connection voltage</i>	Anschlussart <i>connection type</i>	Glasfarbe <i>glass colour</i>	Art.-Nr. <i>Part No.</i>
5 W	12/24 V	Flachstecker 6,3mm flat connector 6.3mm	orange amber	098 221 293

Zusatzartikel

Produktart <i>product type</i>	Artikeltitel <i>article title</i>	Anbauwinkel <i>mounting bracket</i>	Art.-Nr. <i>Part No.</i>
Montageteile mounting hardware	Anbauwinkel mounting bracket	90	098 290 299



▪ **Universal**
Seitenmarkierungsleuchte

▪ **universal**
side marker lamp

Leuchtenfunktionen

Seitenmarkierungslicht
Rückstrahler

lighting functions

side marker light
reflector

Anschlussleistung <i>connected load</i>	Anschlussspannung <i>connection voltage</i>	Anschlussart <i>connection type</i>	Glasfarbe <i>glass colour</i>	Kabellänge <i>cable length</i>	Art.-Nr. <i>Part No.</i>
3 W	12/24 V	Flachstecker 6,3mm Anschluss rechtwinkelig flat connector 6.3mm connection right angled	orange amber	200 mm	098 221 350
3 W	12/24 V	Flachstecker 6,3mm Anschluss rechtwinkelig flat connector 6.3mm connection right angled	orange amber	200 mm	098 221 352

Zusatzartikel

Produktart <i>product type</i>	Artikeltitel <i>article title</i>	Kabellänge <i>cable length</i>	Anschlussart <i>connection type</i>	Anbauwinkel <i>mounting bracket</i>	Art.-Nr. <i>Part No.</i>
Dichtungen sealing	Dichtung sealing				098 291 356
Fassungen bulb holder	Fassung bulb holder	2000 mm	Kabel wire		098 291 357
Fassungen bulb holder	Fassung bulb holder				098 291 358
	Montagerahmen holder			90	098 293 309



■ **Universal**
Seitenmarkierungsleuchte

■ *universal*
side marker lamp

Leuchtenfunktionen

Seitenmarkierungslicht
Rückstrahler

lighting functions

side marker light
reflector

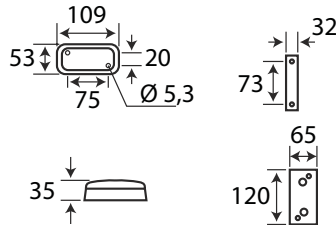

Anschlussleistung <i>connected load</i>	Anschlussspannung <i>connection voltage</i>	Anschlussart <i>connection type</i>	Glasfarbe <i>glass colour</i>	Art.-Nr. <i>Part No.</i>
3 W	12/24 V	Flachstecker 6,3mm PG 7,0 flat connector 6.3mm PG 7,0	orange amber	098 221 383

Zusatzartikel

Produktart <i>product type</i>	Artikeltitel <i>article title</i>	Art.-Nr. <i>Part No.</i>
	PG-Verschraubung PG-connector	099 868 407
Lichtscheiben lens	Lichtscheibe lens	098 291 389

Ⓔ



▪ **Universal LED**
Seitenmarkierungsleuchte

▪ **universal LED**
side marker lamp

Leuchtenfunktionen

Seitenmarkierungslicht
Rückstrahler

lighting functions

side marker light
reflector

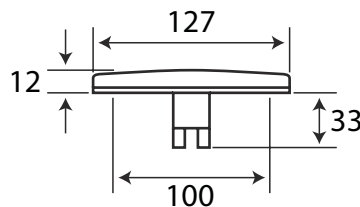

Anschlussleistung connected load	Anschlussspannung connection voltage	Anschlussart connection type	Glasfarbe glass colour	OE- Nr. OE- No.	Art.-Nr. Part No.
3 W	12/24 V	Flachstecker 6,3mm flat connector 6.3mm	orange amber	2PS 962 964-012 2PS 962 964-018	098 221 305

Zusatzartikel

Produktart product type	Artikeltitel article title	OE- Nr. OE- No.	Art.-Nr. Part No.
Fassungen bulb holder	Fassung bulb holder	QGD 963 281-001	098 297 017
Dichtungen sealing	Dichtung sealing	QKK 962 964-001	098 297 015

Ⓔ



▪ **Universal LED**
Seitenmarkierungsleuchte

▪ **universal LED**
side marker lamp

Leuchtenfunktionen

Seitenmarkierungslicht
Rückstrahler

lighting functions

side marker light
reflector

Befesti- gungsart mounting	Anbauwinkel mounting bracket	Anschlussspan- nung connection voltage	Anschlussart connection type	LED Anzahl LED number	Glasfarbe glass colour	Kabellänge cable length	Leucht- mittel illuminant	Art.-Nr. Part No.
Anbauwinkel mounting bracket	90 °	9-33 V	Kabel wire	4	orange amber	500 mm	LED	098 221 611
Anbauwinkel mounting bracket	90 °	9-33 V	Kabel wire	4	orange amber	5000 mm	LED	098 221 615



▪ **Universal LED**
Seitenmarkierungsleuchte

▪ **universal LED**
side marker lamp

Leuchtenfunktionen	lighting functions
Seitenmarkierungslicht Rückstrahler	side marker light reflector

Anschlussspannung connection voltage	Anschlussart connection type	LED Anzahl LED number	Glasfarbe glass colour	OE- Nr. OE- No.	Kabellänge cable length	Leuchtmittel illuminant	Art.-Nr. Part No.
24 V	Click-In	1	orange amber	31-2814-047	500 mm	LED	098 221 215



▪ **Universal LED**
Seitenmarkierungsleuchte

▪ **universal LED**
side marker lamp

Leuchtenfunktionen	lighting functions
Seitenmarkierungslicht Rückstrahler	side marker light reflector

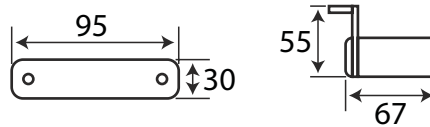

Befesti- gungsart mounting	Anbauwinkel mounting bracket	Anschlussspan- nung connection voltage	Anschlussart connection type	LED Anzahl LED number	Glasfarbe glass colour	OE- Nr. OE- No.	Leucht- mittel illuminant	Art.-Nr. Part No.
Anbauwinkel mounting bracket	90 °	24 V	Bajonett Bayonet	1	orange amber	21-2200- 014	LED	098 221 214



▪ **Universal LED
Seitenmarkierungsleuchte**

▪ **universal LED
side marker lamp**

Leuchtenfunktionen

Seitenmarkierungslicht
Rückstrahler

lighting functions

side marker light
reflector

SEITENBELEUCHTUNG
SIDE LIGHTS

Befestigungsart <i>mounting</i>	Anbauwinkel <i>mounting bracket</i>	Anschlussleistung <i>connected load</i>	Anschlussspannung <i>connection voltage</i>	Anschlussart <i>connection type</i>	LED Anzahl <i>LED number</i>	Glasfarbe <i>glass colour</i>	Leuchtmittel <i>illuminant</i>	Art.-Nr. <i>Part No.</i>
Anbauwinkel mounting bracket	180 °	1.2 W	24 V	JPT	4	orange amber	LED	098 221 252

Zusatzartikel

Produktart <i>product type</i>	Artikeltitel <i>article title</i>	Kabellänge <i>cable length</i>	Art.-Nr. <i>Part No.</i>
Anschlusskabel connection wire	Reparatursätze Steckverbindungen repair kits for plugs	2000 mm	098 291 230



▪ **Universal LED**
Seitenmarkierungsleuchte

▪ *universal LED*
side marker lamp

Leuchtenfunktionen	lighting functions
Seitenmarkierungslicht Rückstrahler	side marker light reflector

Befestigungsart mounting	Anbauwinkel mounting bracket	Anschlussleistung connected load	Anschlussspannung connection voltage	Anschlussart connection type	LED Anzahl LED number	Glasfarbe glass colour	Leuchtmittel illuminant	Art.-Nr. Part No.
Anbauwinkel mounting bracket	90 °	1.2 W	24 V	JPT	4	orange amber	LED	098 221 254

Zusatzartikel

Produktart product type	Artikeltitel article title	Kabellänge cable length	Art.-Nr. Part No.
Anschlusskabel connection wire	Reparatursätze Steckverbindungen repair kits for plugs	2000 mm	098 291 230



▪ **Universal LED**
Seitenmarkierungsleuchte

▪ *universal LED*
side marker lamp

Leuchtenfunktionen	lighting functions
Seitenmarkierungslicht Rückstrahler	side marker light reflector

Befestigungsart mounting	Anbauwinkel mounting bracket	Anschlussleistung connected load	Anschlussspannung connection voltage	Anschlussart connection type	LED Anzahl LED number	Glasfarbe glass colour	Kabel- länge cable length	Leuchtmittel illuminant	Art.-Nr. Part No.
Anbauwinkel mounting bracket	90 °	1.2 W	24 V	Click-In	4	orange amber	1500 mm	LED	098 221 256

Zusatzartikel

Produktart product type	Artikeltitel article title	Kabellänge cable length	Art.-Nr. Part No.
Anschlusskabel connection wire	Reparatursätze Steckverbindungen repair kits for plugs	2000 mm	098 291 230



▪ **Universal LED
 Seitenmarkierungsleuchte**

▪ **universal LED
 side marker lamp**

Leuchtenfunktionen

Seitenmarkierungslicht
 Rückstrahler

lighting functions

side marker light
 reflector

Befestigungsart mounting	Anbauwinkel mounting bracket	Anschlussleistung connected load	Anschlussspannung connection voltage	Anschlussart connection type	LED Anzahl LED number	Glasfarbe glass colour	Kabel- länge cable length	Leucht- mittel illumi- nant	Art.-Nr. Part No.
Anbauwinkel mounting bracket	90 °	0,4/0,8 W	12/24 V	Kabel wire	3	orange amber	500 mm	LED	098 221 942
Anbauwinkel mounting bracket	90 °	0,4/0,8 W	12/24 V	Kabel wire	3	orange amber	5000 mm	LED	098 221 943

Zusatzartikel

Produktart product type	Artikeltitel article title	OE- Nr. OE- No.	Art.-Nr. Part No.
Montageteile mounting hardware	Anbauwinkel mounting bracket	TA 342 120-010	098 291 949



▪ **Universal LED
 Seitenmarkierungsleuchte**

▪ **universal LED
 side marker lamp**

Leuchtenfunktionen

Seitenmarkierungslicht
 Rückstrahler

lighting functions

side marker light
 reflector

Befestigungsart mounting	Anbauwinkel mounting bracket	Anschlussspannung connection voltage	Anschlussart connection type	LED Anzahl LED number	Glasfarbe glass colour	Kabellänge cable length	Leucht- mittel illuminant	Art.-Nr. Part No.
Anbauwinkel mounting bracket	90 °	12 V	Kabel wire	6	orange amber	200 mm	LED	098 221 426
Anbauwinkel mounting bracket	90 °	24 V	Kabel wire	6	orange amber	200 mm	LED	098 221 428



▪ **Universal LED**
Seitenmarkierungsleuchte

▪ **universal LED**
side marker lamp

Leuchtenfunktionen	lighting functions
Seitenmarkierungslicht Rückstrahler	side marker light reflector

Befestigungsart mounting	Anbauwinkel mounting bracket	Anschlussspannung connection voltage	Anschlussart connection type	LED Anzahl LED number	Glasfarbe glass colour	Leuchtmittel illuminant	Art.-Nr. Part No.
Anbauwinkel mounting bracket	180 °	12/24 V	AMP 1.5	2	orange amber	LED	098 221 852

Zusatzartikel

Produktart product type	Artikeltitel article title	Kabellänge cable length	Art.-Nr. Part No.
Anschlusskabel connection wire	Reparatursätze Steckverbindungen repair kits for plugs	2000 mm	098 291 230



▪ **Universal LED**
Seitenmarkierungsleuchte

▪ **universal LED**
side marker lamp

Leuchtenfunktionen	lighting functions
Seitenmarkierungslicht Rückstrahler	side marker light reflector

Befestigungsart mounting	Anbauwinkel mounting bracket	Anschlussspannung connection voltage	Anschlussart connection type	LED Anzahl LED number	Glasfarbe glass colour	Leuchtmittel illuminant	Art.-Nr. Part No.
Anbauwinkel mounting bracket	90 °	12/24 V	AMP 1.5	2	orange amber	LED	098 221 854

Zusatzartikel

Produktart product type	Artikeltitel article title	Kabellänge cable length	Art.-Nr. Part No.
Anschlusskabel connection wire	Reparatursätze Steckverbindungen repair kits for plugs	2000 mm	098 291 230



▪ **Universal**
Seitenmarkierungsleuchte

▪ *universal*
side marker lamp

Leuchtenfunktionen

Seitenmarkierungslicht
Rückstrahler

lighting functions

side marker light
reflector

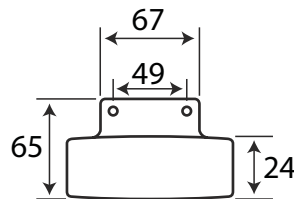

Farbe colour	Befestigungsart mounting	Stromstärke amperage	Anbauwinkel mounting bracket	Anschlussart connection type	Art.-Nr. Part No.
orange amber	Anbauwinkel mounting bracket	12/24 A 12/24	180 °	Flachstecker 6,3mm flat connector 6.3mm	098 221 393



▪ **Universal**
Seitenmarkierungsleuchte

▪ *universal*
side marker lamp

Leuchtenfunktionen

Seitenmarkierungslicht
Rückstrahler

lighting functions

side marker light
reflector

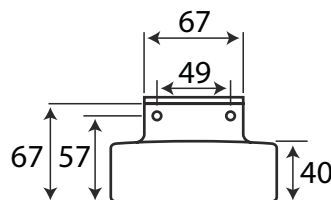

Farbe colour	Befestigungsart mounting	Stromstärke amperage	Anbauwinkel mounting bracket	Anschlussart connection type	Art.-Nr. Part No.
orange amber	Anbauwinkel mounting bracket	12/24 A 12/24	90 °	Flachstecker 6,3mm flat connector 6.3mm	098 221 395



▪ **Universal**
Seitenmarkierungsleuchte

▪ *universal*
side marker lamp

Leuchtenfunktionen

Seitenmarkierungslicht
Rückstrahler

lighting functions

side marker light
reflector

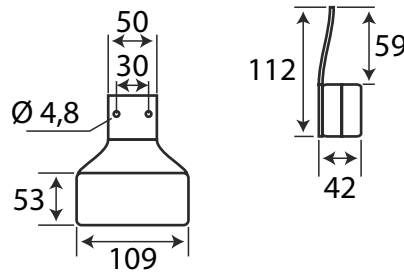

Befestigungsart <i>mounting</i>	Anbauwinkel <i>mounting bracket</i>	Anschlussleistung <i>connected load</i>	Anschlussspannung <i>connection voltage</i>	Anschlussart <i>connection type</i>	Glasfarbe <i>glass colour</i>	Art.-Nr. <i>Part No.</i>
Anbauwinkel mounting bracket	180 °	3 W	12/24 V	PG Verschraubung Flachstecker 6,3mm screw connection PG flat connector 6.3mm	orange amber	098 221 385

Zusatzartikel

Produktart <i>product type</i>	Artikeltitel <i>article title</i>	Art.-Nr. <i>Part No.</i>
	PG-Verschraubung PG-connector	099 868 407
Lichtscheiben lens	Lichtscheibe lens	098 291 389



▪ **Universal**
Seitenmarkierungsleuchte

▪ *universal*
side marker lamp

Leuchtenfunktionen

Seitenmarkierungslicht
Rückstrahler

lighting functions

side marker light
reflector

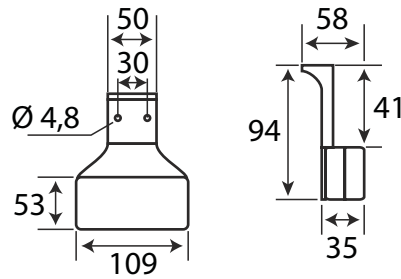

Befestigungsart <i>mounting</i>	Anbauwinkel <i>mounting bracket</i>	Anschlussleistung <i>connected load</i>	Anschlussspannung <i>connection voltage</i>	Anschlussart <i>connection type</i>	Glasfarbe <i>glass colour</i>	Art.-Nr. <i>Part No.</i>
Anbauwinkel mounting bracket	90 °	3 W	12/24 V	PG Verschraubung Flachstecker 6,3mm screw connection PG flat connector 6.3mm	orange amber	098 221 386

Zusatzartikel

Produktart <i>product type</i>	Artikeltitel <i>article title</i>	Art.-Nr. <i>Part No.</i>
	PG-Verschraubung PG-connector	099 868 407
Lichtscheiben lens	Lichtscheibe lens	098 291 389

BLINKLEUCHTEN

INDICATOR LAMPS





▪ DAF LF 45 / 55 2001 >
Blinkleuchte

▪ DAF LF 45 / 55 2001 >
indicator

Leuchtenfunktionen

Blinklicht

lighting functions

indicator

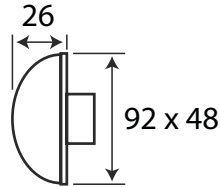

Glasfarbe glass colour	OE- Nr. OE- No.	Art.-Nr. Part No.
gelb yellow	1626101	098 221 837

Zusatzartikel

Produktart product type	Artikeltitel article title	OE- Nr. OE- No.	Art.-Nr. Part No.
Fassungen bulb holder	Fassung bulb holder	500 183 4568 20745066	098 291 510
Stecker connector	KIT JPT 3PK2 Ø 7mm		099 110 378



▪ DAF 95, 95 XF
Blinkleuchte

▪ DAF 95, 95 XF
indicator

Leuchtenfunktionen

Blinklicht

lighting functions

indicator

Glas Art type of glass	Glasfarbe glass colour	OE- Nr. OE- No.	Art.-Nr. Part No.
klar clear	weiß white	130 13 68	098 223 060
klar clear	gelb yellow	006 66 98 038 49 88	098 223 061



▪ DAF 95, CF 65, CF 75, CF 85 > 2003, DAF XF 105 / XC 1005 2006 >
Blinkleuchte

▪ DAF 95, CF 65, CF 75, CF 85 > 2003, DAF XF 105 / XC 1005 2006 >
indicator

Leuchtenfunktionen

Blinklicht

lighting functions

indicator

Glasfarbe
glass colour

OE- Nr.
OE- No.

Art.-Nr.
Part No.

gelb
yellow

181 40 96
181 57 54

098 223 062



▪ DAF 95, CF 65, CF 75, CF 85 > 2003, DAF XF 105 / XC 1005 2006 >
Blinkleuchte

▪ DAF 95, CF 65, CF 75, CF 85 > 2003, DAF XF 105 / XC 1005 2006 >
indicator

Leuchtenfunktionen

Blinklicht

lighting functions

indicator

Glasfarbe
glass colour

OE- Nr.
OE- No.

Art.-Nr.
Part No.

gelb
yellow

139 53 61
173 53 55

098 222 850



▪ Iveco Stralis II, Trakker II
Blinkleuchte

▪ Iveco Stralis II, Trakker II
indicator

Leuchtenfunktionen

Blinklicht

lighting functions

indicator

OE- Nr.
OE- No.

Anbauseite
installation side

Art.-Nr.
Part No.

425 55 051



098 222 324

118 35 000



425 55 042

098 222 323

Zusatzartikel

Produktart
product type

Artikeltitel
article title

Art.-Nr.
Part No.

Stecker
connector

KIT SUPER SEAL NW 4,5

099 110 129



▪ Ivecargo, Stralis I
Blinkleuchte

▪ Ivecargo, Stralis I
indicator

Leuchtenfunktionen

Blinklicht

lighting functions

indicator

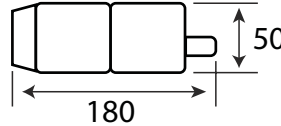

Farbe colour	OE- Nr. OE- No.	Art.-Nr. Part No.
gelb yellow	500 367 924	098 222 317



▪ Ivecargo, Stralis II, Trakker II
Blinkleuchte

▪ Ivecargo, Stralis II, Trakker II
indicator

Leuchtenfunktionen

Blinklicht

lighting functions

indicator

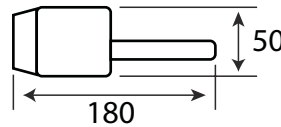

Glasfarbe glass colour	OE- Nr. OE- No.	Art.-Nr. Part No.
gelb yellow	500 367 947	098 222 318



▪ Iveco Stralis 03-06 / Stralis II /
Trakker II
Blinkleuchte

▪ Iveco Stralis 03-06 / Stralis II /
Trakker II
indicator

Leuchtenfunktionen

lighting functions

Blinklicht

indicator

Glasfarbe glass colour	OE- Nr. OE- No.	Anbauseite installation side	Art.-Nr. Part No.
gelb yellow	41 221 029	◀ L	098 222 321
gelb yellow	41 221 039	▶ R	098 222 322

Zusatzartikel

Produktart product type	Artikeltitel article title	Art.-Nr. Part No.
Stecker connector	KIT SUPER SEAL NW 4,5	099 110 129

BESUCHEN SIE
UNSERE HOMEPAGE
WWW.RAL.AT

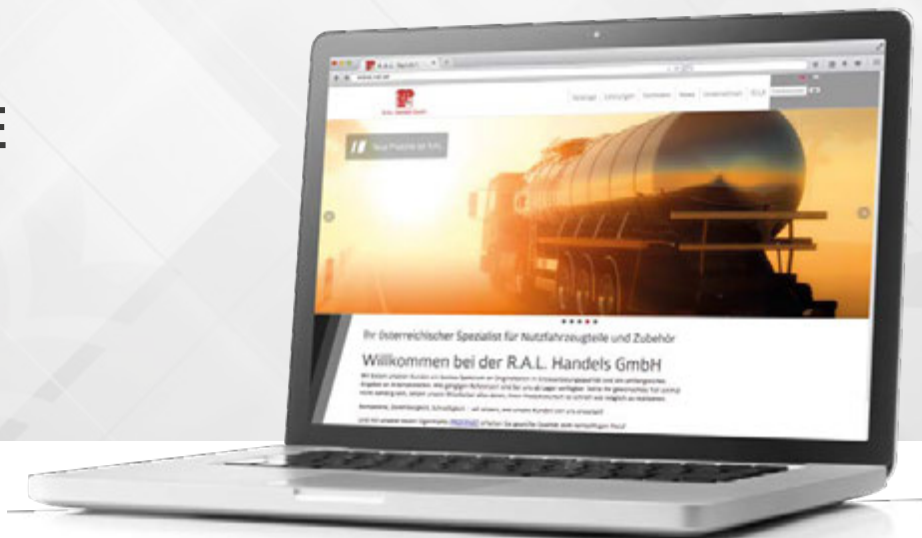



▪ **Iveco Stralis 03-06 / Stralis II / Trakker II Blinkleuchte**

▪ **Iveco Stralis 03-06 / Stralis II / Trakker II indicator**

Leuchtenfunktionen

Blinklicht

lighting functions

indicator

Glasfarbe glass colour	OE- Nr. OE- No.	Anbauseite installation side	Art.-Nr. Part No.
gelb yellow	504 098 245	◀ L	098 222 417
gelb yellow	504 098 243	▶ R	098 222 418

Zusatzartikel

Produktart product type	Artikeltitel article title	Art.-Nr. Part No.
Stecker connector	KIT SUPER SEAL NW 4,5	099 110 129



▪ **Iveco Stralis 03-06 Blinkleuchte**

▪ **Iveco Stralis 03-06 indicator**

Leuchtenfunktionen

Blinklicht

lighting functions

indicator

Glasfarbe glass colour	OE- Nr. OE- No.	Anbauseite installation side	Art.-Nr. Part No.
weiß white	41 221 040	▶ R	098 223 930
weiß white	42 555 022		
weiß white	41 221 041	◀ L	098 223 920
weiß white	42 555 023		

Zusatzartikel

Produktart product type	Artikeltitel article title	Art.-Nr. Part No.
Stecker connector	KIT SUPER SEAL NW 4,5	099 110 129



SEITENBELEUCHTUNG
SIDE LIGHTS



▪ **R.V.I. Magnum AE
Blinkleuchte**

▪ **R.V.I. Magnum AE
indicator**

Leuchtenfunktionen	lighting functions
Blinklicht	indicator

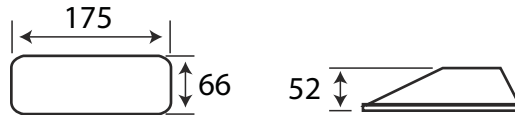

Glasfarbe glass colour	OE- Nr. OE- No.	Art.-Nr. Part No.
gelb yellow	501 021 7023	098 236 827



▪ **R.V.I. Magnum E-Tech 98 -
Blinkleuchte**

▪ **R.V.I. Magnum E-Tech 98 -
indicator**

Leuchtenfunktionen	lighting functions
Blinklicht	indicator

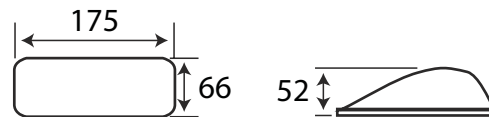

Glasfarbe glass colour	OE- Nr. OE- No.	Art.-Nr. Part No.
gelb yellow	501 027 1807	098 236 829



▪ **R.V.I. Magnum AER.V.I.
Magnum AE
Blinkleuchte**

▪ **R.V.I. Magnum AER.V.I.
Magnum AE
indicator**

Leuchtenfunktionen	lighting functions
Blinklicht	indicator

Glasfarbe glass colour	OE- Nr. OE- No.	Art.-Nr. Part No.
weiß white	501 030 6711	098 221 838

Zusatzartikel

Produktart product type	Artikeltitel article title	OE- Nr. OE- No.	Art.-Nr. Part No.
Fassungen bulb holder	Fassung bulb holder	500 183 4568 20745066	098 291 510
Stecker connector	KIT JPT 3PK2 Ø 7mm		099 110 378

Ⓔ



▪ R.V.I. Premium, Kerax, Midlum
Blinkleuchte

▪ R.V.I. Premium, Kerax, Midlum
indicator

Leuchtenfunktionen

lighting functions

Blinklicht

indicator

Glasfarbe glass colour	OE- Nr. OE- No.	Anbauseite installation side	Art.-Nr. Part No.
weiß white	500 183 4559	▶	098 222 410
weiß white	500 183 4560	◀	098 222 400

Ⓔ



▪ R.V.I. Premium, Kerax, Midlum
95 - 98
Blinkleuchte

▪ R.V.I. Premium, Kerax, Midlum
95 - 98
indicator

Leuchtenfunktionen

lighting functions

Blinklicht

indicator

Glasfarbe glass colour	OE- Nr. OE- No.	Art.-Nr. Part No.
gelb yellow	500 183 4565	098 221 835

Zusatzartikel

Produktart product type	Artikeltitel article title	OE- Nr. OE- No.	Art.-Nr. Part No.
Fassungen bulb holder	Fassung bulb holder	500 183 4568 20745066	098 291 510
Stecker connector	KIT JPT 3PK2 Ø 7mm		099 110 378



SEITENBELEUCHTUNG
SIDE LIGHTS



▪ **R.V.I. Premium, Kerax, Midlum 99 - Blinkleuchte**

▪ *R.V.I. Premium, Kerax, Midlum 99 - indicator*

Leuchtenfunktionen	lighting functions
Blinklicht	indicator

Glasfarbe glass colour	OE- Nr. OE- No.	Art.-Nr. Part No.
gelb yellow	500 184 7597	098 221 836

Zusatzartikel

Produktart product type	Artikeltitel article title	OE- Nr. OE- No.	Art.-Nr. Part No.
Fassungen bulb holder	Fassung bulb holder	500 183 4568 20745066	098 291 510
Stecker connector	KIT JPT 3PK2 Ø 7mm		099 110 378



▪ **Scania P, G, R 08 > Blinkleuchte**

▪ *Scania P, G, R 08 > indicator*

Leuchtenfunktionen	lighting functions
Blinklicht	indicator

Glasfarbe glass colour	OE- Nr. OE- No.	Art.-Nr. Part No.
gelb yellow	1 747 981	098 223 070

Zusatzartikel

Produktart product type	Artikeltitel article title	Art.-Nr. Part No.
Stecker connector	KIT VOLO NW 8,5	099 110 636



▪ Scania P, G, R 08 >
Blinkleuchte

▪ Scania P, G, R 08 >
indicator

Leuchtenfunktionen

Blinklicht

lighting functions

indicator

Glasfarbe <i>glass colour</i>	OE- Nr. <i>OE- No.</i>	Art.-Nr. <i>Part No.</i>
gelb yellow	1 770 301	098 223 075



▪ Volvo FM II / FH II 02 >
Blinkleuchte

▪ Volvo FM II / FH II 02 >
indicator

Leuchtenfunktionen

Blinklicht

lighting functions

indicator

Glasfarbe <i>glass colour</i>	Anbauseite <i>installation side</i>	Art.-Nr. <i>Part No.</i>
gelb yellow	◀ L	098 223 022
gelb yellow	▶ R	098 223 023

Zusatzartikel

Produktart <i>product type</i>	Artikeltitel <i>article title</i>	Glasfarbe <i>glass colour</i>	OE- Nr. <i>OE- No.</i>	Anbauseite <i>installation side</i>	Art.-Nr. <i>Part No.</i>
Blinkleuchte indicator		gelb yellow	20826211 20409874	◀ L	098 223 016
Gehäuse casing	Gehäuse casing		20826227 21430598	◀ L	098 293 024
Blinkleuchte indicator		gelb yellow	20826213 20409875	▶ R	098 223 017
Gehäuse casing	Gehäuse casing		20425419 20826231	▶ R	098 293 025



▪ **Volvo FM II / FH II 02 >**
Blinkleuchte

▪ **Volvo FM II / FH II 02 >**
indicator

Leuchtenfunktionen	lighting functions
Blinklicht	indicator

Glasfarbe glass colour	OE- Nr. OE- No.	Anbauseite installation side	Art.-Nr. Part No.
gelb yellow	20826213 20409875	▶	098 223 017
gelb yellow	20826211 20409874	◀	098 223 016

Zusatzartikel

Produktart product type	Artikeltitel article title	OE- Nr. OE- No.	Anbauseite installation side	Art.-Nr. Part No.
Gehäuse casing	Gehäuse casing	20826227 21430598	◀	098 293 024
Gehäuse casing	Gehäuse casing	20425419 20826231	▶	098 293 025



▪ **Volvo FL, 2000 > Blinkleuchte**

Lichtscheibe ohne Glühlampenfassung

Leuchtenfunktionen

Blinklicht

▪ **Volvo FL, 2000 > indicator**

Lens without socket

lighting functions

indicator

Glasfarbe glass colour	Art.-Nr. Part No.
gelb yellow	098 293 018

Zusatzartikel

Produktart product type	Artikeltitel article title	OE- Nr. OE- No.	Art.-Nr. Part No.
Fassungen bulb holder	Fassung bulb holder	500 183 4568 20745066	098 291 510
Stecker connector	KIT JPT 3PK2 Ø 7mm		099 110 378



▪ **Volvo FH III, FM III 08 > Blinkleuchte**

Leuchtenfunktionen

Blinklicht

▪ **Volvo FH III, FM III 08 > indicator**

lighting functions

indicator

Leuchtmittelfarbe lamp colour	Anschlussspannung connection voltage	LED Anzahl LED number	Glasfarbe glass colour	OE- Nr. OE- No.	Leuchtmittel illuminant	Anbauseite installation side	Art.-Nr. Part No.
orange amber	24 V	12	weiß white	82114506	LED	◀ L	098 223 020
orange amber	24 V	12	weiß white	82114500	LED	▶ R	098 223 021

Zusatzartikel

Produktart product type	Artikeltitel article title	OE- Nr. OE- No.	Anbauseite installation side	Art.-Nr. Part No.
Gehäuse casing	Gehäuse casing	82114508	◀ L	098 293 022
Stecker connector	KIT Scania NW 7,5			099 110 635
Gehäuse casing	Gehäuse casing	82114502	▶ R	098 293 023



SEITENBELEUCHTUNG
SIDE LIGHTS



▪ **F90 1986 > 1999 | 19.272 - 27.502, MAN Bus 1986 > Blinkleuchte**

▪ **F90 1986 > 1999 | 19.272 - 27.502, MAN Bus 1986 > indicator**

Leuchtenfunktionen

Blinklicht

lighting functions

indicator

Glasfarbe glass colour	OE- Nr. OE- No.	Art.-Nr. Part No.
gelb yellow	81.25320-6068	098 222 830



▪ **L/M 2000 Blinkleuchte**

▪ **L/M 2000 indicator**

Leuchtenfunktionen

Blinklicht

lighting functions

indicator

Glasfarbe glass colour	OE- Nr. OE- No.	Art.-Nr. Part No.
gelb yellow	81.25320-6100	910 222 806

Zusatzartikel

Produktart product type	Artikeltitel article title	Art.-Nr. Part No.
Stecker connector	Kupplung connector	099 111 686
Stecker connector	KIT Stecker MAN kit plug MAN	099 111 689
Stecker connector	KIT Steckdose KIT socket	099 111 688



▪ **L/M 2000 Blinkleuchte**

▪ **L/M 2000 indicator**

Leuchtenfunktionen

Blinklicht

lighting functions

indicator

Glasfarbe glass colour	OE- Nr. OE- No.	Art.-Nr. Part No.
gelb yellow	81.25320-6073 81.25320-6096	910 222 804

(E)



▪ **M 2000**
Blinkleuchte

▪ **M 2000**
indicator

Leuchtenfunktionen

lighting functions

Blinklicht

indicator

Glasfarbe glass colour	OE- Nr. OE- No.	Anbauseite installation side	Art.-Nr. Part No.
gelb yellow	85.25320-6002 85.25320-6004	► R	910 222 604
gelb yellow	85.25320-6001 85.25320-6003	◄ L	910 222 603

(E)



▪ **F2000**
Blinkleuchte

▪ **F2000**
indicator

Leuchtenfunktionen

lighting functions

Blinklicht

indicator

Glasfarbe glass colour	OE- Nr. OE- No.	Art.-Nr. Part No.
gelb yellow	81.25320-6087	098 222 808

(E)



▪ **F2000**
Blinkleuchte

▪ **F2000**
indicator

Leuchtenfunktionen

lighting functions

Blinklicht

indicator

Glasfarbe glass colour	OE- Nr. OE- No.	Art.-Nr. Part No.
gelb yellow	81.25320.6084	098 222 805



Ⓔ



▪ **MAN TGA
Blinkleuchte**

▪ **MAN TGA
indicator**

Leuchtenfunktionen

Blinklicht

lighting functions

indicator

Glasfarbe glass colour	OE- Nr. OE- No.	Produktlinie product line	Art.-Nr. Part No.
gelb yellow	81.25320-6115 81.25320-6101 81.25320-6117		198 222 801
			398 222 801

Zusatzartikel

Produktart product type	Artikeltitel article title	Art.-Nr. Part No.
Stecker connector	Kupplung connector	099 111 686
Stecker connector	KIT Stecker MAN kit plug MAN	099 111 689
Stecker connector	KIT Steckdose KIT socket	099 111 688

Ⓔ





▪ **MAN TGX
Blinkleuchte**

▪ **MAN TGX
indicator**

Leuchtenfunktionen
Blinklicht

lighting functions
indicator

Glasfarbe <i>glass colour</i>	OE- Nr. <i>OE- No.</i>	Produktlinie <i>product line</i>	Art.-Nr. <i>Part No.</i>
klar clear	81.25320-6118		198 222 803
klar clear			398 222 803

Zusatzartikel

Produktart <i>product type</i>	Artikeltitel <i>article title</i>	Art.-Nr. <i>Part No.</i>
Stecker connector	Kupplung connector	099 111 686
Stecker connector	KIT Stecker MAN kit plug MAN	099 111 689
Stecker connector	KIT Steckdose KIT socket	099 111 688

**ALLE ARTIKEL FINDEN
SIE AUCH IN UNSEREM
WEBSHOP**





Ⓔ



▪ **MAN Bus
Blinkleuchte**

▪ **MAN Bus
indicator**

Leuchtenfunktionen

Blinklicht

lighting functions

indicator

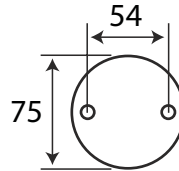

Glasfarbe glass colour	OE- Nr. OE- No.	Art.-Nr. Part No.
gelb yellow	81.25320-6088	910 222 807

Zusatzartikel

Produktart product type	Artikeltitel article title	Art.-Nr. Part No.
Stecker connector	KIT MAN NW 4,5-8,5	099 111 410
Stecker connector	KIT MAN NW 4,5-8,5	099 111 439

Ⓔ



▪ **MAN TGA / TGL / TGM
Blinkleuchte**

▪ **MAN TGA / TGL / TGM
indicator**

Leuchtenfunktionen

Blinklicht

lighting functions

indicator

Glasfarbe glass colour	OE- Nr. OE- No.	Art.-Nr. Part No.
gelb yellow	81.25320-6102	098 222 802

Zusatzartikel

Produktart product type	Artikeltitel article title	Art.-Nr. Part No.
Stecker connector	Kupplung connector	099 111 686
Stecker connector	KIT Stecker MAN KIT plug MAN	099 111 689
Stecker connector	KIT Steckdose KIT socket	099 111 688



▪ **MB Actros I, Axor I
Blinkleuchte**

▪ **MB Actros I, Axor I
indicator**

Leuchtenfunktionen

Blinklicht

lighting functions

indicator

Leuchtmittelfarbe lamp colour	Anschlussspannung connection voltage	Glasfarbe glass colour	OE- Nr. OE- No.	Art.-Nr. Part No.
weiß white	24 V	gelb yellow	941 820 07 21	098 223 005

Zusatzartikel

Produktart product type	Artikeltitel article title	Art.-Nr. Part No.
Stecker connector	KIT JPT 2PK1	099 110 006



▪ **MB Actros I, Axor I
Blinkleuchte**

▪ **MB Actros I, Axor I
indicator**

Leuchtenfunktionen

Blinklicht

lighting functions

indicator

Leuchtmittelfarbe lamp colour	Anschlussspannung connection voltage	Glasfarbe glass colour	OE- Nr. OE- No.	Art.-Nr. Part No.
orange amber	24 V	weiß white	941 820 12 21	098 223 007

Zusatzartikel

Produktart product type	Artikeltitel article title	Art.-Nr. Part No.
Stecker connector	KIT JPT 2PK1	099 110 006



(E)



▪ **MB Actros II 98 > / III
Blinkleuchte**

▪ **MB Actros II 98 > / III
indicator**

Leuchtenfunktionen	lighting functions
Blinklicht	indicator

Anschlussart connection type	Glasfarbe glass colour	OE- Nr. OE- No.	Anbauseite installation side	Art.-Nr. Part No.
Kabel mit Stecker wire with connector	gelb yellow	941 820 09 21	R	198 223 045
Kabel mit Stecker wire with connector	gelb yellow	941 820 05 21	L	198 223 044

Zusatzartikel

Produktart product type	Artikeltitel article title	Glasfarbe glass colour	Anbauseite installation side	Anschlussart connection type	Art.-Nr. Part No.
Lichtscheiben lens	Lichtscheibe lens	gelb yellow	L		098 223 009
Lichtscheiben lens	Lichtscheibe lens	gelb yellow	R		098 223 010
Stecker connector	KIT 4-polig für Kabel Ø 5mm KIT 4-pole for wire Ø 5mm			AMP 1.5 90°	099 110 469

(E)



▪ **MB Atego I, Axor I, Actros I
Blinkleuchte**

▪ **MB Atego I, Axor I, Actros I
indicator**

Leuchtenfunktionen	lighting functions
Blinklicht	indicator

Leuchtmittelfarbe lamp colour	Anschlussspannung connection voltage	Glasfarbe glass colour	OE- Nr. OE- No.	Anbauseite installation side	Art.-Nr. Part No.
weiß white	24 V	gelb yellow	973 820 01 21	L	098 223 001
weiß white	24 V	gelb yellow	973 820 02 21	R	098 223 002

Zusatzartikel

Produktart product type	Artikeltitel article title	Art.-Nr. Part No.
Stecker connector	Stecker connector	099 110 010

Ⓔ



▪ MB Atego 98 >
04, Atego II 04 >
Blinkleuchte

▪ MB Atego 98 >
04, Atego II 04 >
indicator

Leuchtenfunktionen

Blinklicht

lighting functions

indicator

Glasfarbe glass colour	OE- Nr. OE- No.	Produktlinie product line	Anbauseite installation side	Art.-Nr. Part No.
gelb yellow	973 820 03 21	Premium ^{Line}	▶ R	298 223 043
gelb yellow	973 820 04 21	Premium ^{Line}	◀ L	298 223 042
gelb yellow	973 820 03 21	Eco ^{Line}	▶ R	098 223 043
gelb yellow	973 820 03 21	Eco ^{Line}	◀ L	098 223 042

Zusatzartikel

Produktart product type	Artikeltitel article title	Art.-Nr. Part No.
Stecker connector	Stecker connector	099 110 010

Ⓔ



▪ MB Atego II 04 >
Blinkleuchte

▪ MB Atego II 04 >
indicator

Leuchtenfunktionen

Blinklicht

lighting functions

indicator

Glasfarbe glass colour	OE- Nr. OE- No.	Anbauseite installation side	Art.-Nr. Part No.
gelb yellow	973 820 06 21	▶ R	098 222 231
gelb yellow	973 820 05 21	◀ L	098 222 230

Zusatzartikel

Produktart product type	Artikeltitel article title	Art.-Nr. Part No.
Stecker connector	KIT MB Actros, Atego	099 111 116



▪ **MB Atego II 04 >, Axor II 04 >
Blinkleuchte**

▪ **MB Atego II 04 >, Axor II 04 >
indicator**

Leuchtenfunktionen	lighting functions
Blinklicht	indicator

Glasfarbe glass colour	OE- Nr. OE- No.	Art.-Nr. Part No.
gelb yellow	940 820 02 21	098 223 013

Zusatzartikel

Produktart product type	Artikeltitel article title	Anschlussart connection type	Art.-Nr. Part No.
Stecker connector	KIT 4-polig für Kabel Ø 5mm KIT 4-pole for wire Ø 5mm	AMP 1.5 90°	099 110 469
	Stecker connector	AMP 1.5 180°	099 110 743



▪ **B Axor II 04 >
Blinkleuchte**

▪ **B Axor II 04 >
indicator**

Leuchtenfunktionen	lighting functions
Blinklicht	indicator

Glasfarbe glass colour	OE- Nr. OE- No.	Anbauseite installation side	Art.-Nr. Part No.
gelb yellow	940 820 04 21		098 223 047
gelb yellow	940 820 03 21		098 223 046

Zusatzartikel

Produktart product type	Artikeltitel article title	Anschlussart connection type	Anbauwinkel mounting bracket	Art.-Nr. Part No.
Stecker connector	KIT NW 8,5 MB Actros, MB Axor gerade	AMP 1.5 180°	180	099 110 620
Stecker connector	KIT MB Actros, Atego			099 111 116



▪ Mercedes G
Blinkleuchte

▪ Mercedes G
indicator

Leuchtenfunktionen

Blinklicht

lighting functions

indicator

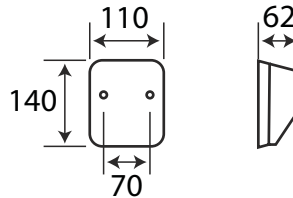

Glasfarbe glass colour	OE- Nr. OE- Nr.	Art.-Nr. Part No.
gelb yellow		098 223 014
weiß white	463 820 00 21	098 223 015

Zusatzartikel

Produktart product type	Artikeltitel article title	Glasfarbe glass colour	Art.-Nr. Part No.
Lichtscheiben lens	Lichtscheibe lens	gelb yellow	098 293 016
Lichtscheiben lens	Lichtscheibe lens	weiß white	098 293 017



▪ MB Evobus Neoplan
Blinkleuchte

▪ MB Evobus Neoplan
indicator

Leuchtenfunktionen

Blinklicht

lighting functions

indicator

Leuchtmittelfarbe lamp colour	Sockelausführung socket version	Anschlussspannung connection voltage	Glasfarbe glass colour	OE- Nr. OE- No.	Kabellänge cable length	Leuchtmittel illuminant	Art.-Nr. Part No.
weiß white	BA15s	24 V	orange amber	2BA 008 805-187 2BA 008 805-057	200 mm		098 223 048
		24 V	orange amber	2BA 008 982-047 2BA 008 982-041	200 mm	LED	098 223 058



▪ **Volvo / Säffle Citybus
Blinkleuchte**

▪ **Volvo / Säffle Citybus
indicator**

Leuchtenfunktionen	lighting functions
Blinklicht	indicator

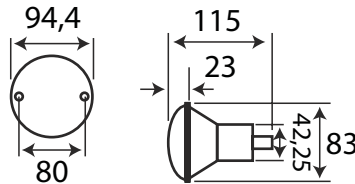

Sockelausführung socket version	Anschlussspannung connection voltage	Glasfarbe glass colour	Art.-Nr. Part No.
BA15s	12/24 V	orange amber	098 223 426



▪ **Neoplan, Scania Citybus, Volvo
/ Säffle Citybus Front
Blinkleuchte**

▪ **Neoplan, Scania Citybus, Volvo
/ Säffle Citybus Front
indicator**

Leuchtenfunktionen	lighting functions
Blinklicht	indicator

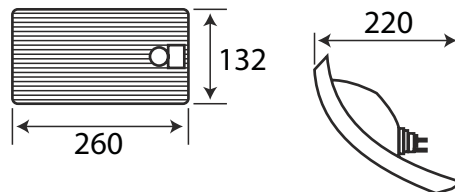

Sockelausführung socket version	Anschlussspannung connection voltage	Glasfarbe glass colour	OE- Nr. OE- No.	Art.-Nr. Part No.
BA15s	12/24 V	orange amber	2BA 005 603-001 2BA 004 119-001	098 223 037
BA15s	12/24 V	orange amber	2BA 005 603-011	098 223 038



▪ MB 0305 / 402 / 405 / 407 / 408, MAN, Kässbohrer, Neoplan, Steyr Bus Blinkleuchte

▪ MB 0305 / 402 / 405 / 407 / 408, MAN, Kässbohrer, Neoplan, Steyr Bus indicator

Leuchtenfunktionen

Blinklicht

lighting functions

indicator

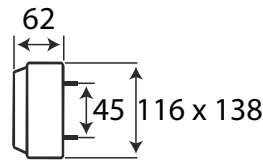

Sockelausführung socket version	Anschlussspannung connection voltage	Glasfarbe glass colour	OE- Nr. OE- No.	Art.-Nr. Part No.
BA15s	12/24 V	orange amber	2BA 003 236-027 2BA 003 236-021	098 225 084



▪ **Universal Blinkleuchte**

▪ **universal indicator**

Leuchtenfunktionen

Blinklicht

lighting functions

indicator

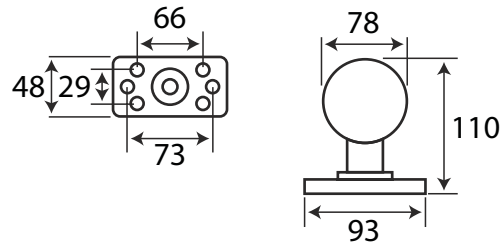

Leuchtmittelfarbe lamp colour	Sockelausführung socket version	Anschlussspannung connection voltage	LED Anzahl LED number	Glasfarbe glass colour	OE- Nr. OE- No.	Leuchtmittel illuminant	Art.-Nr. Part No.
weiß white	BA15s	12/24 V		orange amber	2BM 800 000-001		098 221 161
weiß white	BA15s	12/24 V	12	orange amber		LED	098 221 066

Zusatzartikel

Produktart product type	Artikeltitel article title	Sockelausführung socket version	Art.-Nr. Part No.
LED Einheiten LED Unit	LED Einsatz LED Unit		098 291 066
Lichtscheiben lens	Lichtscheibe lens		098 291 167
Fassungen bulb holder	Glühlampenfassung bulb holder	BA15s	098 291 166
Montageartikel mounting hardware	Gummiunterlage rubber base		098 291 119



▪ **Universal
Blinkleuchte**

▪ *universal
indicator*

Leuchtenfunktionen	lighting functions
Blinklicht	indicator

Leuchtmittelfarbe lamp colour	Sockelausführung socket version	Anschlussspannung connection voltage	LED Anzahl LED Anzahl	Glasfarbe glass colour	OE- Nr. OE- No.	Leuchtmittel Leuchtmittel	Art.-Nr. Part No.
weiß white	BA15s	12/24 V		orange amber	2BM 780 000-001		098 221 171
weiß white		24 V	12	orange amber		LED	098 221 075

Zusatzartikel

Produktart product type	Artikeltitel article title	Sockelausführung socket version	Art.-Nr. Part No.
Lichtscheiben lens	Lichtscheibe lens		098 291 167
Fassungen bulb holder	Glühlampenfassung bulb holder	BA15s	098 291 166
Montageteile mounting hardware	Gummiunterlage rubber base		098 291 119
LED Einheiten LED Unit	LED Einsatz LED Unit		098 291 066



▪ **Bus
Blinkleuchte**

▪ *Bus
indicator*

Leuchtenfunktionen	lighting functions
Blinklicht	indicator

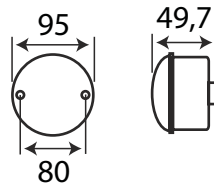

Leuchtmittelfarbe lamp colour	Anschlussspannung connection voltage	Glasfarbe glass colour	Kabellänge cable length	Leuchtmittel illuminant	Art.-Nr. Part No.
weiß white	12 V	orange amber	500 mm	LED	098 226 092
weiß white	24 V	orange amber	500 mm	LED	098 226 094



▪ **Bus
Blinkleuchte**

▪ **Bus
indicator**

Leuchtenfunktionen
Blinklicht

lighting functions
indicator

Leuchtmittelfarbe <i>lamp colour</i>	Anschlussspannung <i>connection voltage</i>	Glasfarbe <i>glass colour</i>	Leuchtmittel <i>illuminant</i>	Art.-Nr. <i>Part No.</i>
weiß white	10-30 V	orange amber	LED	098 222 630



▪ **Bus
Blinkleuchte**

▪ **Bus
indicator**

Leuchtenfunktionen
Blinklicht

lighting functions
indicator

Leuchtmittelfarbe <i>lamp colour</i>	Anschlussspannung <i>connection voltage</i>	Glasfarbe <i>glass colour</i>	Leuchtmittel <i>illuminant</i>	Art.-Nr. <i>Part No.</i>
weiß white	9-33 V	orange amber	LED	098 225 530



▪ **Bus
Blinkleuchte**

▪ **Bus
indicator**

Leuchtenfunktionen	lighting functions
Blinklicht	indicator

Leuchtmittelfarbe lamp colour	Anschlussspannung connection voltage	Glasfarbe glass colour	Leuchtmittel illuminant	Art.-Nr. Part No.
weiß white	9-33 V	orange amber	LED	098 226 530



▪ **Bus
Blinkleuchte**

▪ **Bus
indicator**

Leuchtenfunktionen	lighting functions
Blinklicht	indicator

Leuchtmittelfarbe lamp colour	Anschlussspannung connection voltage	Glasfarbe glass colour	Leuchtmittel illuminant	Art.-Nr. Part No.
orange amber	9-33 V	weiß white	LED	098 226 535



▪ **Bus
Blinkleuchte**

▪ **Bus
indicator**

Leuchtenfunktionen	lighting functions
Blinklicht	indicator

Leuchtmittelfarbe lamp colour	Anschlussspannung connection voltage	Glasfarbe glass colour	Leuchtmittel illuminant	Art.-Nr. Part No.
weiß white	9-33 V	orange amber	LED	098 225 700



▪ **Universal
Blinkleuchte**

Mickey Mouse Design

Leuchtenfunktionen

Blinklicht

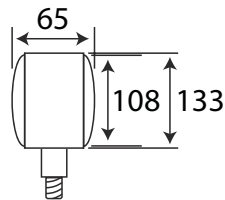

▪ **universal
indicator**

Mickey Mouse design

lighting functions

indicator

Sockelausführung socket version	Anschlussspannung connection voltage	Glasfarbe glass colour	Art.-Nr. Part No.
BA15s	12/24 V	orange amber	098 224 300



▪ **Universal
Blinkleuchte**

Leuchtenfunktionen

Blinklicht

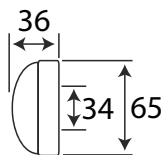

▪ **universal
indicator**

lighting functions

indicator

Sockelausführung socket version	Anschlussspannung connection voltage	Glasfarbe glass colour	Art.-Nr. Part No.
SV8,5	12/24 V	orange amber	098 224 490



▪ **Universal
Blinkleuchte**

Für vorderen Anbau

Leuchtenfunktionen

Blinklicht

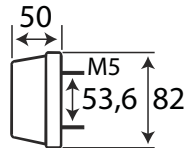

▪ **universal
indicator**

For front installation

lighting functions

indicator

Sockelausführung socket version	Anschlussspannung connection voltage	Glasfarbe glass colour	Art.-Nr. Part No.
BA15s	12/24 V	orange amber	098 222 500



▪ **Universal
Blinkleuchte**

Leuchtenfunktionen

Blinklicht

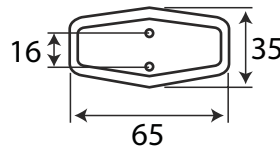

▪ **universal
indicator**

lighting functions

indicator

Sockelausführung socket version	Anschlussspannung connection voltage	Glasfarbe glass colour	Art.-Nr. Part No.
BA9s	12/24 V	orange amber	098 228 400

Zusatzartikel

Produktart product type	Artikeltitel article title	Art.-Nr. Part No.
Lichtscheiben lens	Lichtscheibe lens	098 298 407



▪ **Universal
Blinkleuchte**

▪ *universal
indicator*

Leuchtenfunktionen	lighting functions
Blinklicht	indicator

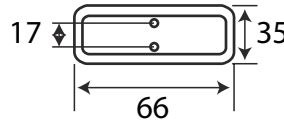

Sockelausführung socket version	Anschlussspannung connection voltage	Glasfarbe glass colour	Art.-Nr. Part No.
SV8,5	12/24 V	orange amber	098 221 550



▪ **Universal
Blinkleuchte**

▪ *universal
indicator*

Für vorderen und seitlichen Anbau

For frontal and lateral installation

Leuchtenfunktionen	lighting functions
Blinklicht	indicator

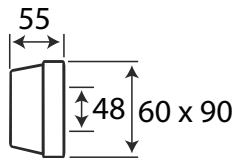

Sockelausführung socket version	Anschlussspannung connection voltage	Glasfarbe glass colour	Anbauseite installation side	Art.-Nr. Part No.
BA15s	12/24 V	orange amber	L	098 227 470
BA15s	12/24 V	orange amber	R	098 227 471

**SEITENBELEUCHTUNG
SIDE LIGHTS****Universal
Blinkleuchte**

Mit Anschlusskabel für seitlichen Anbau

**universal
indicator***With connection wire for lateral
installation*

Leuchtenfunktionen	lighting functions
Blinklicht	indicator

Sockelausführung socket version	Anschlussspannung connection voltage	Glasfarbe glass colour	Art.-Nr. Part No.
BA15s	12/24 V	orange amber	098 221 450

Zusatzartikel

Produktart product type	Artikeltitel article title	Glasfarbe glass colour	Art.-Nr. Part No.
Streuscheiben lens	Streuscheibe lens	weiß white	098 291 457

BEGRENZUNGSLEUCHTEN

MARKER LAMPS





▪ **Universal LED**
Begrenzungsleuchte

▪ **universal LED**
marker lamp

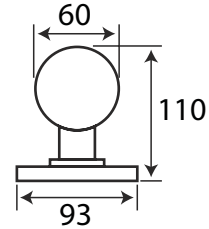
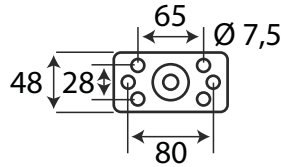

Anschlussleistung <i>connected load</i>	Anschlussspannung <i>connection voltage</i>	Anschlussart <i>connection type</i>	LED Anzahl <i>LED number</i>	Glasfarbe <i>glass colour</i>	Kabellänge <i>cable length</i>	Leuchtmittel <i>illuminant</i>	Art.-Nr. <i>Part No.</i>
1,05 W	12/24 V	Kabel wire	2	rot, weiß red, white	1250 mm	LED	098 241 016

Zusatzartikel

Produktart <i>product type</i>	Artikeltitel <i>article title</i>	Glasfarbe <i>glass colour</i>	Art.-Nr. <i>Part No.</i>
LED Einheiten LED Unit	LED Einsatz LED Unit	rot red	098 291 012
LED Einheiten LED Unit	LED Einsatz LED Unit	transparent	098 291 016

**INFORMIEREN SIE SICH
AUCH ÜBER UNSERE
WARN- UND ARBEITSLEUCHTEN**

WWW.RAL.AT





▪ **Universal LED**
Begrenzungsleuchte

▪ *universal LED*
marker lamp

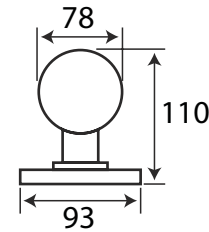
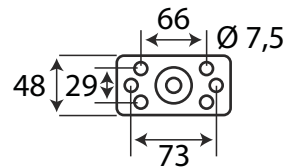

Anschlussleistung connected load	Anschlussspannung connection voltage	Anschlussart connection type	LED Anzahl LED number	Glasfarbe glass colour	Kabellänge cable length	Leuchtmittel illuminant	Art.-Nr. Part No.
2,4 W	24 V	Kabel wire	2	rot, weiß red, white	4750 mm	LED	098 241 065

Zusatzartikel

Artikeltitle article title	Glasfarbe glass colour	Art.-Nr. Part No.
LED Einsatz LED Unit	rot red	098 291 062
LED Einsatz LED Unit	weiß white	098 291 064



▪ **Universal LED**
Begrenzungsleuchte

▪ *universal LED*
marker lamp

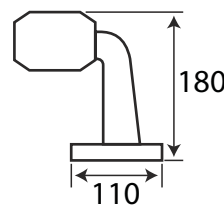

Anschlussspannung connection voltage	Anschlussart connection type	LED Anzahl LED number	Glasfarbe glass colour	Kabellänge cable length	Leuchtmittel illuminant	Art.-Nr. Part No.
24 V	Click-In	2	rot, weiß red, white	500 mm	LED	098 241 241

Zusatzartikel

Artikeltitle article title	Glasfarbe glass colour	Kabellänge cable length	Anschlussart connection type	Art.-Nr. Part No.
LED Einsatz LED Unit	rot, weiß red, white	500 mm	offenes Kabel open cable	098 291 250
LED Einsatz LED Unit	rot, weiß red, white	500 mm	Click-In	098 291 251



▪ **Universal LED**
Begrenzungsleuchte

▪ *universal LED*
marker lamp

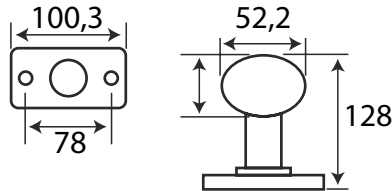

Anschlussleistung <i>connected load</i>	Anschlussspannung <i>connection voltage</i>	Anschlussart <i>connection type</i>	LED Anzahl <i>LED number</i>	Glasfarbe <i>glass colour</i>	Kabellänge <i>cable length</i>	Leuchtmittel <i>illuminant</i>	Art.-Nr. <i>Part No.</i>
1,3 W	12 V	Kabel wire	9	rot, weiß, orange red, white, amber	500 mm	LED	098 241 030
0,7 W	24 V	Kabel wire	9	rot, weiß, orange red, white, amber	500 mm	LED	098 241 031



▪ **Universal LED**
Begrenzungsleuchte

▪ *universal LED*
marker lamp

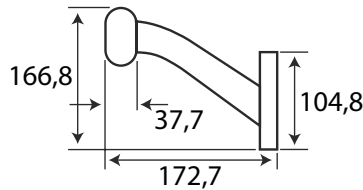

Anschlussleistung <i>connected load</i>	Anschlussspannung <i>connection voltage</i>	Anschlussart <i>connection type</i>	LED Anzahl <i>LED number</i>	Glasfarbe <i>glass colour</i>	Kabel- länge <i>cable length</i>	Leucht- mittel <i>illuminant</i>	Anbauseite <i>installation side</i>	Art.-Nr. <i>Part No.</i>	
1,3 W	12 V	Kabel wire	9	rot, weiß, orange red, white, amber	500 mm	LED	◀ L	098 241 034	
1,3 W	12 V	Kabel wire	9	rot, weiß, orange red, white, amber	500 mm	LED	▶ R	098 241 035	
0,7 W	24 V	Kabel wire	9	rot, weiß, orange red, white, amber	500 mm	LED	◀ L	098 241 036	
0,7 W	24 V	Kabel wire	9	rot, weiß, orange red, white, amber	500 mm	LED	▶ R	098 241 037	
								4000 mm	910 290 707



▪ **Universal LED Begrenzungsleuchte**

▪ *universal LED marker lamp*

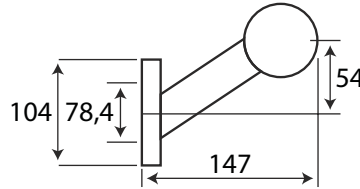

Leuchtmittel-farbe <i>lamp colour</i>	Anschlussspan-nung <i>connection voltage</i>	Anschlussart <i>connection type</i>	LED Anzahl <i>LED number</i>	Glasfarbe <i>glass colour</i>	Kabellänge <i>cable length</i>	Leucht-mittel <i>illuminant</i>	Anbauseite <i>installation side</i>	Art.-Nr. <i>Part No.</i>
rot, weiß, orange red, white, amber	12/24 V	Kabel Click-In wire Click-In	3	transparent	1500 mm	LED	◀ L	098 241 282
rot, weiß, orange red, white, amber	12/24 V	Kabel Click-In wire Click-In	3	transparent	1500 mm	LED	▶ R	098 241 283

Zusatzartikel

Produktart <i>product type</i>	Artikeltitel <i>article title</i>	Kabellänge <i>cable length</i>	Art.-Nr. <i>Part No.</i>
LED Einheiten LED Unit	LED Einsatz LED Unit	4000 mm	910 290 707



▪ **Universal LED Begrenzungsleuchte**

▪ *universal LED marker lamp*

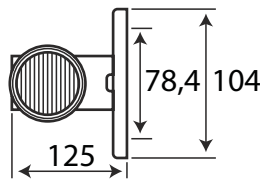

Leuchtmittelfarbe <i>lamp colour</i>	Anschlussspannung <i>connection voltage</i>	Anschlussart <i>connection type</i>	LED Anzahl <i>LED number</i>	Glasfarbe <i>glass colour</i>	Kabellänge <i>cable length</i>	Leuchtmittel <i>illuminant</i>	Art.-Nr. <i>Part No.</i>
rot, weiß, orange red, white, amber	12/24 V	Kabel Click-In wire Click-In	3	transparent	1500 mm	LED	098 241 297



SEITENBELEUCHTUNG
SIDE LIGHTS



▪ Universal LED Begrenzungsleuchte

▪ universal LED marker lamp

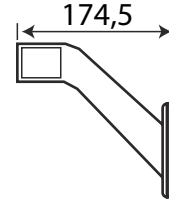
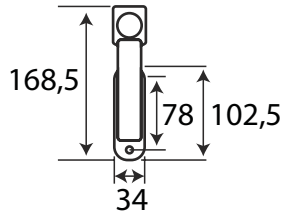

Anschlussspannung connection voltage	Anschlussart connection type	LED Anzahl LED number	Glasfarbe glass colour	Kabellänge cable length	Leuchtmittel illuminant	Art.-Nr. Part No.
24 V	Kabel wire	5	rot, weiß, orange red, white, amber	500 mm	LED	098 241 455



▪ Universal LED Begrenzungsleuchte

▪ universal LED marker lamp

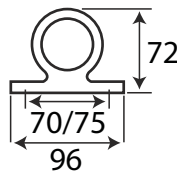

Anschlussspannung connection voltage	Anschlussart connection type	LED Anzahl LED number	Glasfarbe glass colour	Kabellänge cable length	Leuchtmittel illuminant	Art.-Nr. Part No.
12/24 V	Kabel wire	3	rot, weiß red, white	300 mm	LED	098 241 500



▪ **Universal LED**
Begrenzungsleuchte

▪ **universal LED**
marker lamp

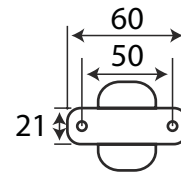
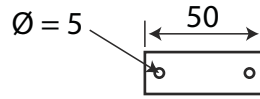
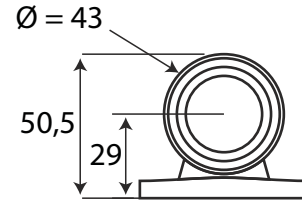
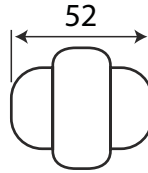

Leuchtmittel- farbe lamp colour	Anschlussleis- tung connected load	Anschlussspan- nung connection voltage	Anschlussart connection type	LED Anzahl LED number	Glasfarbe glass colour	Kabellänge cable length	Leucht- mittel illuminant	Art.-Nr. Part No.
weiß rot white red	0,4/0,8 W	12/24 V	Kabel wire	2	klar clear	340 mm	LED	098 241 420



▪ **Universall**
Begrenzungsleuchte

▪ **universal**
marker lamp

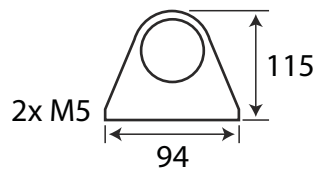

Sockelausführung socket version	Anschlussspannung connection voltage	Anschlussart connection type	LED Anzahl LED number	Glasfarbe glass colour	Kabellänge cable length	Leuchtmittel illuminant	Art.-Nr. Part No.
BA15s	12/24 V	Kabel wire		rot, weiß red, white	200 mm		098 241 190
			2	rot, weiß red, white		LED	098 241 490



▪ **Universal LED
Begrenzungsleuchte**

▪ *universal LED
marker lamp*

Farbe colour	Leuchtmittel- farbe lamp colour	Anschlussspan- nung connection voltage	Anschlussart connection type	LED Anzahl LED number	Glasfarbe glass colour	Kabellänge cable length	Leucht- mittel illuminant	Art.-Nr. Part No.
schwarz black	weiß white	24 V	Kabel wire	2	klar, rot clear, red	100 mm	LED	j12.0015.000
schwarz black	weiß white	9-32 V	Kabel wire	2	klar, rot clear, red	100 mm	LED	j12.0016.000
weiß white	weiß white	12 V	Kabel wire	2	klar, rot clear, red	100 mm	LED	j12.0014.020
weiß white	weiß white	24 V	Kabel wire	2	klar, rot clear, red	100 mm	LED	j12.0015.200
grau grey	weiß white	12 V	Kabel wire	2	klar, rot clear, red	100 mm	LED	j12.0014.300
grau grey	weiß white	24 V	Kabel wire	2	klar, rot clear, red	500 mm	LED	j12.0015.300



▪ **Universal LED
Begrenzungsleuchte**

▪ **universal LED
marker lamp**

Befestigungsart mounting	Leuchtmittelfarbe lamp colour	Anbauwinkel mounting bracket	Anschlussspannung connection voltage	Anschlussart connection type	LED Anzahl LED number	Glasfarbe glass colour	OE- Nr. OE- No.	Kabellänge cable length	Leuchtmittel illuminant	Art.-Nr. Part No.
	rot weiß red white		9-32 V	Kabel wire	2	klar, rot clear, red	2XS 340 827-011	1000 mm	LED	098 241 310
	rot weiß red white		9-32 V	AMP Superseal	2	klar clear			LED	098 241 314
	rot weiß orange red white amber		9-32 V	Kabel wire	3	klar clear		1000 mm	LED	098 241 312
	rot weiß orange red white amber		9-32 V	AMP Superseal	3	klar clear			LED	098 241 316
Anbauwinkel mounting bracket	rot weiß red white	90 °	9-32 V	Kabel wire	2	klar clear		1000 mm	LED	098 241 330
Anbauwinkel mounting bracket	rot weiß red white	90 °	9-32 V	AMP Superseal	2	klar clear			LED	098 241 334



▪ **Universal LED
Begrenzungsleuchte**

▪ **universal LED
marker lamp**

Befestigungsart <i>mounting</i>	Leuchtmittelfarbe <i>lamp colour</i>	Anbauwinkel <i>mounting bracket</i>	Anschlussspannung <i>connection voltage</i>	Anschlussart <i>connection type</i>	LED Anzahl <i>LED number</i>	Glasfarbe <i>glass colour</i>	OE- Nr. <i>OE- No.</i>	Kabellänge <i>cable length</i>	Leuchtmittel <i>illuminant</i>	Art.-Nr. <i>Part No.</i>
Anbauwinkel mounting bracket	rot weiß orange red white amber	90 °	9-32 V	Kabel wire	3	klar clear		1000 mm	LED	098 241 332
Anbauwinkel mounting bracket	rot weiß orange red white amber	90 °	9-32 V	AMP Superseal	3	klar clear			LED	098 241 336
Gummi- pendel rubber pendulum	rot weiß red white		9-32 V	Kabel wire	2	klar clear		1000 mm	LED	098 241 320
Gummi- pendel rubber pendulum	rot weiß red white		9-32 V	AMP Superseal	2	klar clear			LED	098 241 324
Gummi- pendel rubber pendulum	rot weiß orange red white amber		9-32 V	Kabel wire	3	klar clear		1000 mm	LED	098 241 322
Gummi- pendel rubber pendulum	rot weiß orange red white amber		9-32 V	AMP Superseal	3	klar clear			LED	098 241 326



▪ **Universal LED
 Begrenzungsleuchte**

▪ **universal LED
 marker lamp**

Befestigungsart mounting	Leuchtmittelfarbe lamp colour	Anbauwinkel mounting bracket	Anschlussspannung connection voltage	Anschlussart connection type	LED Anzahl LED number	Glasfarbe glass colour	Kabellänge cable length	Leuchtmittel illuminant	Art.-Nr. Part No.
	rot weiß orange red white amber		12/24 V	Kabel wire	6	klar clear	500 mm	LED	898 241 005
	rot weiß red white		12/24 V	Kabel wire	6	klar clear	500 mm	LED	898 241 010
Anbauwinkel mounting bracket	rot weiß orange red white amber	90 °	12/24 V	Kabel wire	6	klar clear	500 mm	LED	898 241 025
Anbauwinkel mounting bracket	rot weiß red white	90 °	12/24 V	Kabel wire	6	klar clear	500 mm	LED	898 241 030
Gummipendel rubber pendulum	rot weiß orange red white amber		12/24 V	Kabel wire	6	klar clear	500 mm	LED	898 241 015
Gummipendel rubber pendulum	rot weiß red white		12/24 V	Kabel wire	6	klar clear	500 mm	LED	898 241 020



E



▪ **Universal
Begrenzungsleuchte**

▪ *universal
marker lamp*

Anschlussspannung <i>connection voltage</i>	Anschlussart <i>connection type</i>	Glasfarbe <i>glass colour</i>	Kabellänge <i>cable length</i>	Art.-Nr. <i>Part No.</i>
12/24 V	Kabel wire	rot, weiß red, white	300 mm	098 241 110

Zusatzartikel

Produktart <i>product type</i>	Artikeltitel <i>article title</i>	Sockelausführung <i>socket version</i>	Anschlussart <i>connection type</i>	Sockelfarbe <i>holder colour</i>	Art.-Nr. <i>Part No.</i>
Fassungen bulb holder	Glühlampenfassung mit Schraubanschluss bulb holder with screw	BA15s			098 291 126
Fassungen bulb holder	Glühlampenfassung bulb holder	BA15s	Kabel wire		098 291 125
Lichtscheiben lens	Lichtscheibe lens			rot red	098 291 128
	Glühlampenfassung bulb holder			klar clear	098 291 129
Lichtscheiben lens	Lichtscheibe lens			schwarz black	098 291 124

Ⓔ



▪ **Universal
 Begrenzungsleuchte**

▪ *universal
 marker lamp*

Anschlussspannung <i>connection voltage</i>	Anschlussart <i>connection type</i>	Glasfarbe <i>glass colour</i>	Art.-Nr. <i>Part No.</i>
12/24 V	Kabel wire	rot, weiß red, white	098 241 160

Zusatzartikel

Produktart <i>product type</i>	Artikeltitel <i>article title</i>	Glasfarbe <i>glass colour</i>	Sockelausführung <i>socket version</i>	Art.-Nr. <i>Part No.</i>
Fassungen bulb holder	Glühlampenfassung bulb holder		BA15s	098 291 166
Lichtscheiben lens	Lichtscheibe lens	rot red		098 291 168
Lichtscheiben lens	Lichtscheibe lens	klar clear		098 291 169



Ⓔ



▪ **Universal
Begrenzungsleuchte**

▪ *universal
marker lamp*

Anschlussspannung connection voltage	Anschlussart connection type	Glasfarbe glass colour	Kabellänge cable length	Art.-Nr. Part No.
12/24 V	Click-In	rot, weiß red, white	500 mm	098 241 230

Zusatzartikel

Produktart product type	Artikeltitel article title	Glasfarbe glass colour	Sockelausführung socket version	Art.-Nr. Part No.
Fassungen bulb holder	Lichtscheibe lens	weiß, schwarz white, black		098 291 223
Lichtscheiben lens	Lichtscheibe lens	rot, weiß red, white		098 291 221
Fassungen bulb holder	Glühlampenfassung bulb holder		BA9s	098 291 225

Ⓔ



▪ **Universal
Begrenzungsleuchte**

▪ *universal
marker lamp*

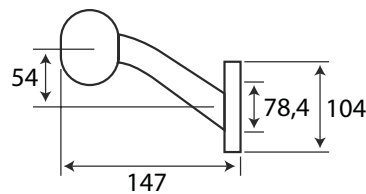

Anschlussspannung connection voltage	Anschlussart connection type	Glasfarbe glass colour	Kabellänge cable length	Anbauseite installation side	Art.-Nr. Part No.
12/24 V	Click-In	rot, weiß, orange red, white, amber	1250 mm	◀ L	098 241 280
12/24 V	Click-In	rot, weiß, orange red, white, amber	1250 mm	▶ R	098 241 281

Zusatzartikel

Produktart product type	Artikeltitel article title	Glasfarbe glass colour	Sockelausführung socket version	Art.-Nr. Part No.
Lichtscheiben lens	Lichtscheibe lens	rot, weiß, orange red, white, amber	BA9s	098 295 037



▪ **Universal
 Begrenzungsleuchte**

▪ *universal
 marker lamp*

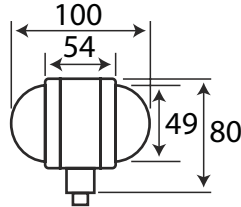

Sockelausführung socket version	Anschlussspannung connection voltage	Glasfarbe glass colour	Art.-Nr. Part No.
BA15s	12/24 V	rot, weiß red, white	098 242 003

Ⓔ



▪ **Universal
 Begrenzungsleuchte**

▪ *universal
 marker lamp*

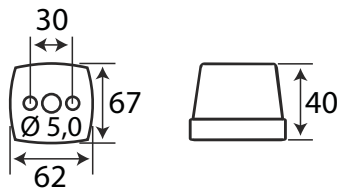

Sockelausführung socket version	Anschlussspannung connection voltage	Anschlussart connection type	Glasfarbe glass colour	Art.-Nr. Part No.
SV8,5-36	12/24 V	Kabeldurchführung wire bushing	rot, weiß red, white	098 241 815



Ⓔ



▪ **Universal
Begrenzungsleuchte**

▪ *universal
marker lamp*

Sockelausführung socket version	Anschlussspannung connection voltage	Anschlussart connection type	Glasfarbe glass colour	Art.-Nr. Part No.
BA15s	12/24 V	Kabeldurchführung wire bushing	rot, weiß red, white	098 241 350

Zusatzartikel

Produktart product type	Artikeltitel article title	Glasfarbe glass colour	Art.-Nr. Part No.
Lichtscheiben lens	Lichtscheibe lens	rot, weiß red, white	098 291 353

Ⓔ



▪ **Universal
Begrenzungsleuchte**

▪ *universal
marker lamp*

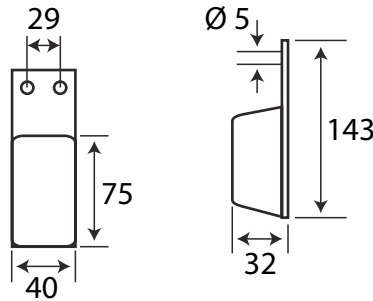

Befestigungsart mounting	Sockelausführung socket version	Anschlussspannung connection voltage	Anschlussart connection type	Glasfarbe glass colour	Art.-Nr. Part No.
Gummipendel rubber pendulum	SV8,5-36	12/24 V	Kabeldurchführung wire bushing	rot, weiß red, white	098 246 880

Zusatzartikel

Produktart product type	Artikeltitel article title	Glasfarbe glass colour	Art.-Nr. Part No.
Lichtscheiben lens	Lichtscheibe lens	rot, weiß red, white	098 296 889



▪ **Universal LED**
Begrenzungsleuchte

▪ *universal LED*
marker lamp

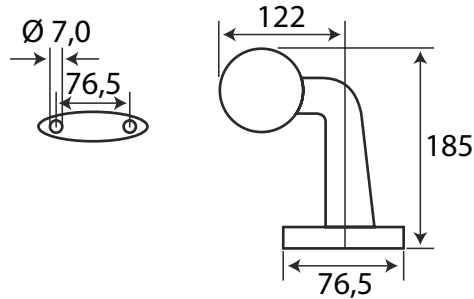

Anschlussleistung <i>connected load</i>	Anschlussspannung <i>connection voltage</i>	Anschlussart <i>connection type</i>	LED Anzahl <i>LED number</i>	Glasfarbe <i>glass colour</i>	Kabellänge <i>cable length</i>	Leuchtmittel <i>illuminant</i>	Art.-Nr. <i>Part No.</i>
0,5 W	12/24 V	Kabel wire	2	rot, weiß red, white	1250 mm	LED	098 241 026

Zusatzartikel

Produktart <i>product type</i>	Artikeltitel <i>article title</i>	Glasfarbe <i>glass colour</i>	Art.-Nr. <i>Part No.</i>
LED Einheiten LED Unit	LED Einsatz LED Unit	rot red	098 291 012
LED Einheiten LED Unit	LED Einsatz LED Unit	transparent	098 291 016



▪ **Universal LED**
Begrenzungsleuchte

▪ *universal LED*
marker lamp

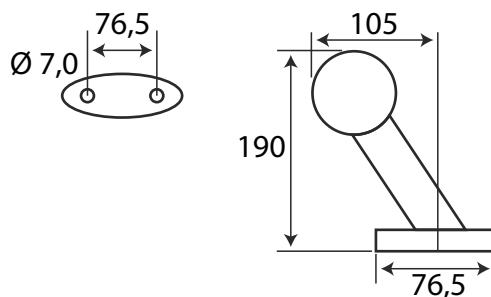

Anschlussleistung <i>connected load</i>	Anschlussspannung <i>connection voltage</i>	Anschlussart <i>connection type</i>	LED Anzahl <i>LED number</i>	Glasfarbe <i>glass colour</i>	Kabellänge <i>cable length</i>	Leuchtmittel <i>illuminant</i>	Art.-Nr. <i>Part No.</i>
0,5 W	12/24 V	Kabel wire	2	rot, weiß red, white	1250 mm	LED	098 241 086

Zusatzartikel

Produktart <i>product type</i>	Artikeltitel <i>article title</i>	Glasfarbe <i>glass colour</i>	Art.-Nr. <i>Part No.</i>
LED Einheiten LED Unit	LED Einsatz LED Unit	rot red	098 291 012
LED Einheiten LED Unit	LED Einsatz LED Unit	transparent	098 291 016



▪ **Universal LED Begrenzungsleuchte**

▪ *universal LED marker lamp*

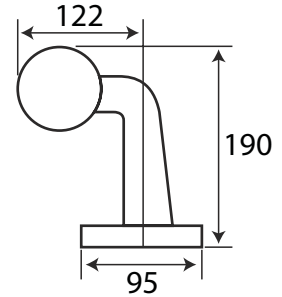
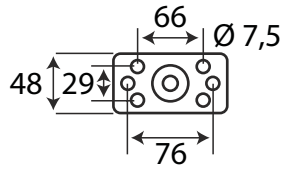

Anschlussleistung <i>connected load</i>	Anschlussspannung <i>connection voltage</i>	Anschlussart <i>connection type</i>	LED Anzahl <i>LED number</i>	Glasfarbe <i>glass colour</i>	Kabellänge <i>cable length</i>	Leuchtmittel <i>illuminant</i>	Art.-Nr. <i>Part No.</i>
2,4 W	24 V	Kabel wire	2	rot, weiß red, white	4750 mm	LED	098 241 075

Zusatzartikel

Produktart <i>product type</i>	Artikeltitel <i>article title</i>	Glasfarbe <i>glass colour</i>	Art.-Nr. <i>Part No.</i>
LED Einheiten LED Unit	LED Einsatz LED Unit	rot red	098 291 062
LED Einheiten LED Unit	LED Einsatz LED Unit	weiß white	098 291 064



▪ **Universal LED Begrenzungsleuchte**

▪ *universal LED marker lamp*

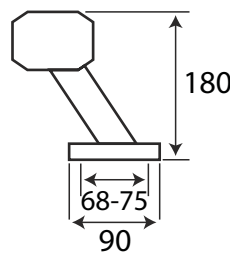

Anschlussspannung <i>connection voltage</i>	Anschlussart <i>connection type</i>	LED Anzahl <i>LED number</i>	Glasfarbe <i>glass colour</i>	Kabellänge <i>cable length</i>	Leuchtmittel <i>illuminant</i>	Art.-Nr. <i>Part No.</i>
24 V	Click-In	2	rot, weiß red, white	500 mm	LED	098 241 244

Zusatzartikel

Produktart <i>product type</i>	Artikeltitel <i>article title</i>	Glasfarbe <i>glass colour</i>	Kabellänge <i>cable length</i>	Anschlussart <i>connection type</i>	Art.-Nr. <i>Part No.</i>
LED Einheiten LED Unit	LED Einsatz LED Unit	rot, weiß red, white	500 mm	offenes Kabel open cable	098 291 250
LED Einheiten LED Unit	LED Einsatz LED Unit	rot, weiß red, white	500 mm	Click-In	098 291 251



▪ **Universal LED**
 Begrenzungsleuchte

▪ *universal LED*
 marker lamp

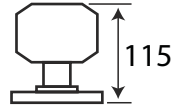

Anschlussspannung connection voltage	Anschlussart connection type	LED Anzahl LED number	Glasfarbe glass colour	Kabellänge cable length	Leuchtmittel illuminant	Art.-Nr. Part No.
24 V	Click-In	2	rot, weiß red, white	500 mm	LED	098 241 247

Zusatzartikel

Produktart product type	Artikeltitel article title	Glasfarbe glass colour	Kabellänge cable length	Anschlussart connection type	Art.-Nr. Part No.
LED Einheiten LED Unit	LED Einsatz LED Unit	rot, weiß red, white	500 mm	offenes Kabel open cable	098 291 250
LED Einheiten LED Unit	LED Einsatz LED Unit	rot, weiß red, white	500 mm	Click-In	098 291 251



▪ **Universal LED**
 Begrenzungsleuchte

▪ *universal LED*
 marker lamp

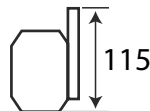

Anschlussspannung connection voltage	Anschlussart connection type	LED Anzahl LED number	Glasfarbe glass colour	Kabellänge cable length	Leuchtmittel illuminant	Art.-Nr. Part No.
24 V	Click-In	2	rot, weiß red, white	700 mm	LED	098 241 249

Zusatzartikel

Produktart product type	Artikeltitel article title	Glasfarbe glass colour	Kabellänge cable length	Anschlussart connection type	Art.-Nr. Part No.
LED Einheiten LED Unit	LED Einsatz LED Unit	rot, weiß red, white	500 mm	offenes Kabel open cable	098 291 250
LED Einheiten LED Unit	LED Einsatz LED Unit	rot, weiß red, white	500 mm	Click-In	098 291 251



▪ Universal LED
Begrenzungsleuchte

▪ universal LED
marker lamp

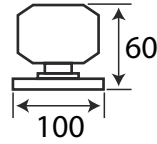

Anschlussspannung connection voltage	Anschlussart connection type	LED Anzahl LED number	Glasfarbe glass colour	Kabellänge cable length	Leuchtmittel illuminant	Art.-Nr. Part No.
24 V	Click-In	2	rot, weiß red, white	700 mm	LED	098 241 248

Zusatzartikel

Produktart product type	Artikeltitel article title	Glasfarbe glass colour	Kabellänge cable length	Anschlussart connection type	Art.-Nr. Part No.
LED Einheiten LED Unit	LED Einsatz LED Unit	rot, weiß red, white	500 mm	offenes Kabel open cable	098 291 250
LED Einheiten LED Unit	LED Einsatz LED Unit	rot, weiß red, white	500 mm	Click-In	098 291 251

BESUCHEN SIE
UNSERE HOMEPAGE
WWW.FAHRZEUGBEDARF.AT



Ⓔ



▪ **Universal
 Begrenzungsleuchte**

▪ *universal
 marker lamp*

Anschlussspannung <i>connection voltage</i>	Anschlussart <i>connection type</i>	Glasfarbe <i>glass colour</i>	Kabellänge <i>cable length</i>	Art.-Nr. <i>Part No.</i>
12/24 V	Kabel wire	rot, weiß red, white	300 mm	098 241 120

Zusatzartikel

Produktart <i>product type</i>	Artikeltitel <i>article title</i>	Sockelausführung <i>socket version</i>	Anschlussart <i>connection type</i>	Sockelfarbe <i>holder colour</i>	Art.-Nr. <i>Part No.</i>
Fassungen bulb holder	Glühlampenfassung mit Schraubanschluss bulb holder with screw	BA15s			098 291 126
Fassungen bulb holder	Glühlampenfassung bulb holder	BA15s	Kabel wire		098 291 125
Lichtscheiben lens	Lichtscheibe lens			rot red	098 291 128
	Glühlampenfassung bulb holder			klar clear	098 291 129
Lichtscheiben lens	Lichtscheibe lens			schwarz black	098 291 124



E

▪ **Universal
Begrenzungsleuchte**▪ *universal
marker lamp*

Anschlussspannung <i>connection voltage</i>	Anschlussart <i>connection type</i>	Glasfarbe <i>glass colour</i>	Kabellänge <i>cable length</i>	Art.-Nr. <i>Part No.</i>
12/24 V	Kabel wire	rot, weiß red, white	300 mm	098 241 180

Zusatzartikel

Produktart <i>product type</i>	Artikeltitel <i>article title</i>	Sockelausführung <i>socket version</i>	Anschlussart <i>connection type</i>	Sockelfarbe <i>holder colour</i>	Art.-Nr. <i>Part No.</i>
Fassungen bulb holder	Glühlampenfassung mit Schraubanschluss bulb holder with screw	BA15s			098 291 126
Fassungen bulb holder	Glühlampenfassung bulb holder	BA15s	Kabel wire		098 291 125
Lichtscheiben lens	Lichtscheibe lens			rot red	098 291 128
	Glühlampenfassung bulb holder			klar clear	098 291 129
Lichtscheiben lens	Lichtscheibe lens			schwarz black	098 291 124

Ⓔ



▪ **Universal
 Begrenzungsleuchte**

▪ *universal
 marker lamp*

Anschlussspannung connection voltage	Anschlussart connection type	Glasfarbe glass colour	Art.-Nr. Part No.
12/24 V	Kabel wire	rot, weiß red, white	098 241 170

Zusatzartikel

Produktart product type	Artikeltitel article title	Glasfarbe glass colour	Sockelausführung socket version	Art.-Nr. Part No.
Fassungen bulb holder	Glühlampenfassung bulb holder		BA15s	098 291 166
Lichtscheiben lens	Lichtscheibe lens	rot red		098 291 168
Lichtscheiben lens	Lichtscheibe lens	klar clear		098 291 169

Ⓔ



▪ **Universal
 Begrenzungsleuchte**

▪ *universal
 marker lamp*

Anschlussspannung connection voltage	Anschlussart connection type	Glasfarbe glass colour	Kabellänge cable length	Art.-Nr. Part No.
12/24 V	Click-In	rot, weiß red, white	500 mm	098 241 233

Zusatzartikel

Produktart product type	Artikeltitel article title	Glasfarbe glass colour	Sockelausführung socket version	Art.-Nr. Part No.
Fassungen bulb holder	Lichtscheibe lens	weiß, schwarz white, black		098 291 223
Lichtscheiben lens	Lichtscheibe lens	rot, weiß red, white		098 291 221
Fassungen bulb holder	Glühlampenfassung bulb holder		BA9s	098 291 225



E

**Universal
Begrenzungsleuchte****universal
marker lamp**

Anschlussspannung <i>connection voltage</i>	Anschlussart <i>connection type</i>	Glasfarbe <i>glass colour</i>	Kabellänge <i>cable length</i>	Art.-Nr. <i>Part No.</i>
12/24 V	Click-In	rot, weiß red, white	500 mm	098 241 236

Zusatzartikel

Produktart <i>product type</i>	Artikeltitel <i>article title</i>	Glasfarbe <i>glass colour</i>	Sockelausführung <i>socket version</i>	Art.-Nr. <i>Part No.</i>
Fassungen bulb holder	Lichtscheibe lens	weiß, schwarz white, black		098 291 223
Lichtscheiben lens	Lichtscheibe lens	rot, weiß red, white		098 291 221
Fassungen bulb holder	Glühlampenfassung bulb holder		BA9s	098 291 225

E

**Universal
Begrenzungsleuchte****universal
marker lamp**

Anschlussspannung <i>connection voltage</i>	Anschlussart <i>connection type</i>	Glasfarbe <i>glass colour</i>	Kabellänge <i>cable length</i>	Art.-Nr. <i>Part No.</i>
12/24 V	Click-In	rot, weiß, orange red, white, amber	1500 mm	098 241 292

Zusatzartikel

Produktart <i>product type</i>	Artikeltitel <i>article title</i>	Glasfarbe <i>glass colour</i>	Sockelausführung <i>socket version</i>	Art.-Nr. <i>Part No.</i>
Lichtscheiben lens	Lichtscheibe lens	rot, weiß, orange red, white, amber	BA9s	098 295 037

Ⓔ



▪ **Universal
 Begrenzungsleuchte**

▪ *universal
 marker lamp*

Befestigungsart <i>mounting</i>	Sockelausführung <i>socket version</i>	Anschlussspannung <i>connection voltage</i>	Anschlussart <i>connection type</i>	Glasfarbe <i>glass colour</i>	Art.-Nr. <i>Part No.</i>
Gummipendel rubber pendulum	BA15s	12/24 V	Kabeldurchführung wire bushing	rot, weiß red, white	098 241 352

Zusatzartikel

Produktart <i>product type</i>	Artikeltitel <i>article title</i>	Glasfarbe <i>glass colour</i>	Art.-Nr. <i>Part No.</i>
Lichtscheiben lens	Lichtscheibe lens	rot, weiß red, white	098 291 353

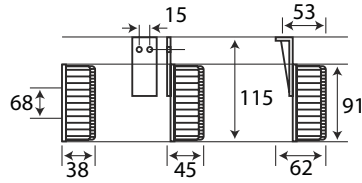

E

**Universal
Begrenzungsleuchte****universal
marker lamp**

Befestigungsart <i>mounting</i>	Sockelausführung <i>socket version</i>	Anschlussspannung <i>connection voltage</i>	Anschlussart <i>connection type</i>	Glasfarbe <i>glass colour</i>	Art.-Nr. <i>Part No.</i>
Gummipendel gewinkelt anged rubber pendulum	BA15s	12/24 V	Kabeldurchführung wire bushing	rot, weiß red, white	098 241 354

Zusatzartikel

Produktart <i>product type</i>	Artikeltitel <i>article title</i>	Glasfarbe <i>glass colour</i>	Art.-Nr. <i>Part No.</i>
Lichtscheiben lens	Lichtscheibe lens	rot, weiß red, white	098 291 353

INNENLEUCHTEN

INTERIOR LAMPS





▪ **Universal
Innenbeleuchtung**

▪ *universal
interior lamp*

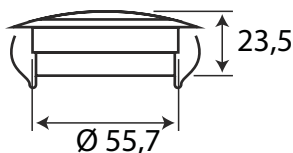

Befestigungsart <i>mounting</i>	Stromstärke <i>amperage</i>	Anschlussspannung <i>connection voltage</i>	LED Anzahl <i>LED number</i>	Kabellänge <i>cable length</i>	Leuchtmittel <i>illuminant</i>	Art.-Nr. <i>Part No.</i>
Einbauversion for built in	0.1 A	24 V	18	200 mm	LED	098 271 718

Zusatzartikel

Produktart <i>product type</i>	Artikeltitel <i>article title</i>	Art.-Nr. <i>Part No.</i>
Montageteile mounting hardware	Aufbaurahmen holder for built-on	098 292 719



▪ **Universal
Innenbeleuchtung**

▪ *universal
interior lamp*

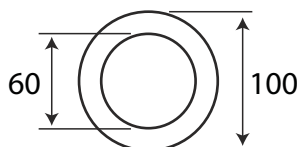

Befestigungsart <i>mounting</i>	Stromstärke <i>amperage</i>	Anschlussspannung <i>connection voltage</i>	Anschlussart <i>connection type</i>	LED Anzahl <i>LED number</i>	Kabellänge <i>cable length</i>	Leuchtmittel <i>illuminant</i>	Art.-Nr. <i>Part No.</i>
Anbauversion for built on	0.14 A	12 V	2-polig 2-pole	24	200 mm	LED	098 271 722
Anbauversion for built on	0.075 A	24 V	2-polig 2-pole	24	200 mm	LED	098 271 724



▪ **Universal
Innenbeleuchtung**

▪ *universal
interior lamp*

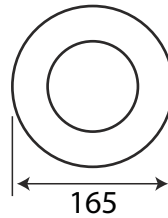

Lichtstrom <i>luminous lux</i>	Befestigungsart <i>mounting</i>	Stromstärke <i>amperage</i>	Leuchtmittelfarbe <i>lamp colour</i>	Anschlussspannung <i>connection voltage</i>	LED Anzahl <i>LED number</i>	Leuchtmittel <i>illuminant</i>	Art.-Nr. <i>Part No.</i>
300 lm	Anbauversion for built on	0.38 A	weiß white	24 V	5	LED	098 271 050
300 lm	Anbauversion for built on	0.7 A	weiß white	12 V	5	LED	098 271 053
300 lm	Anbauversion for built on	0.38 A	weiß white	24 V	5	LED	098 271 051
300 lm	Anbauversion for built on	0.7 A	weiß white	12 V	5	LED	098 271 052



▪ **Universal
Innenbeleuchtung**

▪ *universal
interior lamp*

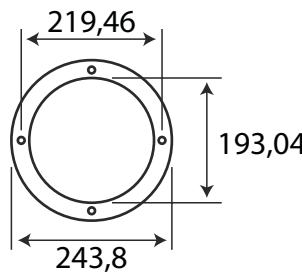

Lichtstrom <i>luminous lux</i>	Befestigungsart <i>mounting</i>	Stromstärke <i>amperage</i>	Leuchtmittelfarbe <i>lamp colour</i>	Anschlussspannung <i>connection voltage</i>	LED Anzahl <i>LED number</i>	Leuchtmittel <i>illuminant</i>	Betriebstemperatur <i>temperature</i>	Art.-Nr. <i>Part No.</i>
800 lm	Einbauversion for built in	0.75 A	weiß white	24 V	12	LED	-40	098 271 054
800 lm	Einbauversion for built in	1.92 A	weiß white	12 V	12	LED	-40	098 271 055



SONDERLEUCHTEN
SPECIAL LIGHTS



▪ **Universal
Innenbeleuchtung**

▪ *universal
interior lamp*

Befestigungsart <i>mounting</i>	Anschlussleistung <i>connected load</i>	Anschlussspannung <i>connection voltage</i>	LED Anzahl <i>LED number</i>	Kabellänge <i>cable length</i>	Leuchtmittel <i>illuminant</i>	Art.-Nr. <i>Part No.</i>
Anbauversion for built on	3,5 W	9-33 V	20	150 mm	LED	098 274 086
Einbauversion for built in	3,5 W	9-33 V	20	150 mm	LED	098 274 096



▪ **Universal
Innenbeleuchtung**

▪ *universal
interior lamp*

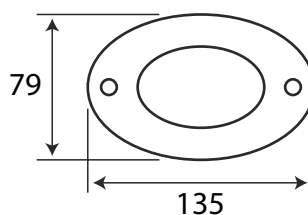

Anschlussspannung <i>connection voltage</i>	LED Anzahl <i>LED number</i>	Leuchtmittel <i>illuminant</i>	Art.-Nr. <i>Part No.</i>
12/24 V	6	LED	098 271 073



▪ **Universal Innenbeleuchtung**

▪ *universal interior lamp*

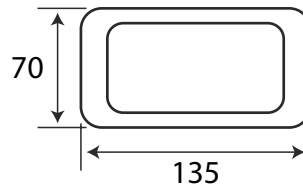

Leuchtmittelfarbe <i>lamp colour</i>	Anschlussspannung <i>connection voltage</i>	LED Anzahl <i>LED number</i>	Leuchtmittel <i>illuminant</i>	Art.-Nr. <i>Part No.</i>
weiß white	12 V	30	LED	098 271 732
weiß white	24 V	30	LED	098 271 734



▪ **Universal Innenbeleuchtung**

▪ *universal interior lamp*

Leuchtmittelfarbe <i>lamp colour</i>	Anschlussspannung <i>connection voltage</i>	LED Anzahl <i>LED number</i>	Leuchtmittel <i>illuminant</i>	Art.-Nr. <i>Part No.</i>
weiß white	12 V	30	LED	098 271 742
weiß white	24 V	30	LED	098 271 744



▪ **S13 Superlux Innenbeleuchtung**

▪ *S13 Superlux interior lamp*

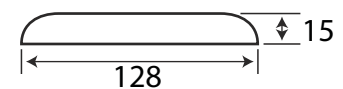
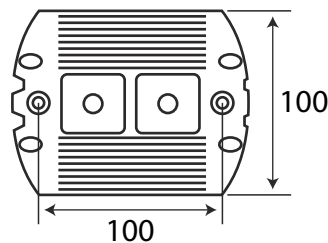

Lichtstrom <i>luminous lux</i>	Anschlussleistung <i>connected load</i>	Anschlussspannung <i>connection voltage</i>	Leuchtmittel <i>illuminant</i>	Art.-Nr. <i>Part No.</i>
200 lm	2 x 5,0 W	10-32 V	LED	098 275 012



▪ **Universal
Innenbeleuchtung**

▪ *universal
interior lamp*

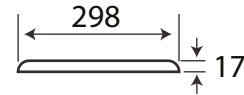
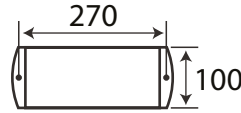

Lichtstrom <i>luminous lux</i>	Anschlussleistung <i>connected load</i>	Anschlussspannung <i>connection voltage</i>	Kabellänge <i>cable length</i>	Leuchtmittel <i>illuminant</i>	Art.-Nr. <i>Part No.</i>
500 lm	5x 2,5 W	10-32 V	200 mm	LED	098 275 008

▪ **Deckenleuchte
Innenbeleuchtung**

▪ *Scenelite S16
interior lamp*

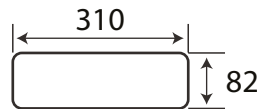

Farbe <i>colour</i>	Lichtstrom <i>luminous lux</i>	Anschlussleistung <i>connected load</i>	Anschlussspannung <i>connection voltage</i>	Kabellänge <i>cable length</i>	Leuchtmittel <i>illuminant</i>	Art.-Nr. <i>Part No.</i>
grau grey	1704 lm	18 W	10-32 V	200 mm	LED	098 275 016
weiß white	1704 lm	18 W	10-32 V	200 mm	LED	098 275 026

▪ **Universal
Innenbeleuchtung**

▪ *universal
interior lamp*



mit blauem Nachtlicht

with blue night light

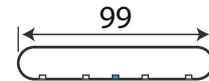
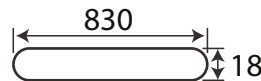

Befestigungsart <i>mounting</i>	Leuchtmittelfarbe <i>lamp colour</i>	Anschlussspannung <i>connection voltage</i>	LED Anzahl <i>LED number</i>	Kabellänge <i>cable length</i>	Leuchtmittel <i>illuminant</i>	Art.-Nr. <i>Part No.</i>
Anbauversion for built on	weiß blau white blue	12 V	112	300 mm	LED	098 274 132
Anbauversion for built on	weiß blau white blue	24 V	112	300 mm	LED	098 274 134



▪ **Deckenfluter
Innenbeleuchtung**

▪ *recessed mount dome lamp
interior lamp*

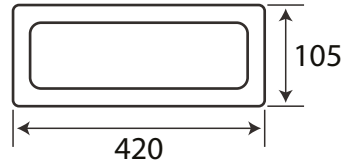

SONDERLEUCHTEN
SPECIAL LIGHTS

Lichtstrom <i>luminous lux</i>	Befestigungsart <i>mounting</i>	Stromstärke <i>amperage</i>	Anschlussspannung <i>connection voltage</i>	LED Anzahl <i>LED number</i>	Leuchtmittel <i>illuminant</i>	Art.-Nr. <i>Part No.</i>
1100 lm	Einbauversion for built in	1 A	24 V	16	LED	098 271 059
1200 lm	Einbauversion for built in	2.16 A	12 V	16	LED	098 271 060



▪ **Universal
Innenbeleuchtung**

▪ *universal
interior lamp*

Länge <i>length</i>	Befestigungsart <i>mounting</i>	Anschlussspannung <i>connection voltage</i>	Glasfarbe <i>glass colour</i>	Leuchtmittel <i>illuminant</i>	Art.-Nr. <i>Part No.</i>
130 mm	Anbauversion for built on	12 V	weiß white	LED	098 274 206
370 mm	Anbauversion for built on	12 V	weiß white	LED	098 274 218
610 mm	Anbauversion for built on	12 V	weiß white	LED	098 274 230
130 mm	Anbauversion for built on	24 V	weiß white	LED	098 274 406
370 mm	Anbauversion for built on	24 V	weiß white	LED	098 274 418
610 mm	Anbauversion for built on	24 V	weiß white	LED	098 274 430



▪ **Universal Innenbeleuchtung**

▪ *universal interior lamp*

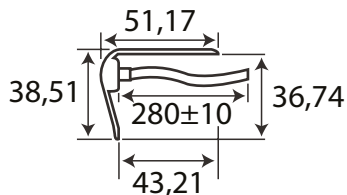

Leuchtmittelfarbe <i>lamp colour</i>	Anschlussspannung <i>connection voltage</i>	LED Anzahl <i>LED number</i>	Leuchtmittel <i>illuminant</i>	Art.-Nr. <i>Part No.</i>
weiß white	24 V	9	LED	098 274 600
gelb yellow	24 V	9	LED	098 274 610
rot red	24 V	9	LED	098 274 620
blau blue	24 V	9	LED	098 274 630



▪ **Universal "slim white" Innenbeleuchtung**

▪ *universal "slim white" interior lamp*



Lichtstrom <i>luminous lux</i>	Befestigungsart <i>mounting</i>	Stromstärke <i>amperage</i>	Leuchtmittelfarbe <i>lamp colour</i>	Anschlussspannung <i>connection voltage</i>	Leuchtmittel <i>illuminant</i>	Art.-Nr. <i>Part No.</i>
490 lm	Anbauversion for built on	0.3 A	weiß / schwarz white / black	24 V	LED	098 271 061
490 lm	Anbauversion for built on	0.6 A	weiß / schwarz white / black	12 V	LED	098 271 063
490 lm	Anbauversion for built on	0.3 A	weiß / schwarz white / black	24 V	LED	098 271 062
490 lm	Anbauversion for built on	0.6 A	weiß / schwarz white / black	12 V	LED	098 271 064



▪ **Universal Innenbeleuchtung**

▪ *universal interior lamp*

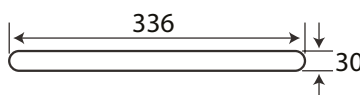

Lichtstrom <i>luminous lux</i>	Befestigungsart <i>mounting</i>	Stromstärke <i>amperage</i>	Anschlussspannung <i>connection voltage</i>	LED Anzahl <i>LED number</i>	Leuchtmittel <i>illuminant</i>	Art.-Nr. <i>Part No.</i>
140 lm	Anbauversion for built on	0.23 A	12 V	24	LED	098 271 066
140 lm	Anbauversion for built on	0.23 A	12 V	24	LED	098 271 067



▪ **ASTRO LL2**
Innenbeleuchtung

▪ **ASTRO LL2**
interior lamp

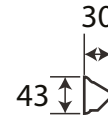
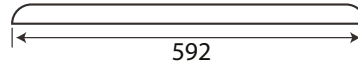

Stromstärke amperage	Leuchtmittelfarbe lamp colour	Anschlussspannung connection voltage	Leuchtmittel illuminant	Art.-Nr. Part No.
0.18 A	cool white	12 V	LED	098 274 652
0.09 A	cool white	24 V	LED	098 274 650



▪ **Universal**
Innenbeleuchtung

▪ **universal**
interior lamp

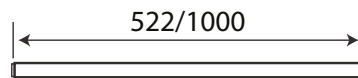

Länge length	Stromstärke amperage	Anschlussspannung connection voltage	Leuchtmittel illuminant	Art.-Nr. Part No.
522 mm	0.09 A	24 V	LED	098 274 640
1000 mm	0.09 A	24 V	LED	098 274 645



SONDERLEUCHTEN
SPECIAL LIGHTS



▪ **Universal
Innenbeleuchtung**

▪ *universal
interior lamp*

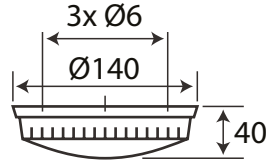

Befestigungsart <i>mounting</i>	Sockelausführung <i>socket version</i>	Anschlussspannung <i>connection voltage</i>	Art.-Nr. <i>Part No.</i>
Anbauversion for built on	BA15s	12/24 V	098 271 081

Zusatzartikel

Produktart <i>product type</i>	Artikeltitel <i>article title</i>	Art.-Nr. <i>Part No.</i>
Lichtscheiben lens	Lichtscheibe lens	098 291 090



▪ **Universal
Innenbeleuchtung**

▪ *universal
interior lamp*

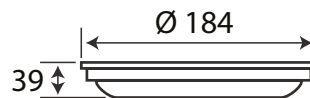

Befestigungsart <i>mounting</i>	Sockelausführung <i>socket version</i>	Anschlussspannung <i>connection voltage</i>	Art.-Nr. <i>Part No.</i>
Anbauversion for built on	BA15s	12/24 V	098 271 044



▪ **Universal Innenbeleuchtung**

▪ *universal interior lamp*

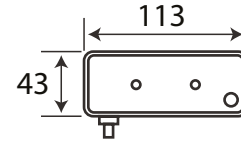
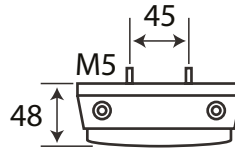

Befestigungsart <i>mounting</i>	Sockelausführung <i>socket version</i>	Anschlussspannung <i>connection voltage</i>	Art.-Nr. <i>Part No.</i>
Anbauversion for built on	SV8,5-36	12/24 V	098 271 125



▪ **LED zone light weiß Innenbeleuchtung**

▪ *LED "zone light" white interior lamp*

Lichtstrom <i>luminous lux</i>	Stromstärke <i>amperage</i>	Anschlussspannung <i>connection voltage</i>	Kabellänge <i>cable length</i>	Leuchtmittel <i>illuminant</i>	Betriebstemperatur <i>temperature</i>	Art.-Nr. <i>Part No.</i>
1000 lm	1.8 A (12V) 0.9 A (24V)	10-30 V	300 mm	LED	-30 bis 85	098 275 076



▪ **LED zone light Innenbeleuchtung**

▪ *LED "zone light" interior lamp*

Lichtstrom <i>luminous lux</i>	Stromstärke <i>amperage</i>	Anschlussspannung <i>connection voltage</i>	Kabellänge <i>cable length</i>	Leuchtmittel <i>illuminant</i>	Betriebstemperatur <i>temperature</i>	Art.-Nr. <i>Part No.</i>
1000 lm	1.8 A (12V) 0.9 A (24V)	10-30 V	300 mm	LED	-30 bis 85	098 275 077



SONDERLEUCHTEN
SPECIAL LIGHTS



▪ **Universal
Innenbeleuchtung**

▪ *universal
interior lamp*

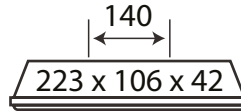

Befestigungsart <i>mounting</i>	Sockelausführung <i>socket version</i>	Anschlussspannung <i>connection voltage</i>	Art.-Nr. <i>Part No.</i>
Anbauversion for built on	BA15s	12/24 V	098 271 170



▪ **Universal
Innenbeleuchtung**

▪ *universal
interior lamp*



Betätigungsart <i>actuation type</i>	Befestigungsart <i>mounting</i>	Anschlussleistung <i>connected load</i>	Anschlussspannung <i>connection voltage</i>	Art.-Nr. <i>Part No.</i>
Druckknopfschalter push-button switch	Anbauversion for built on	2x 8 W	12 V	098 272 382
Druckknopfschalter push-button switch	Anbauversion for built on	2x 8 W	24 V	098 272 384



▪ **Universal
Innenbeleuchtung**

▪ *universal
interior lamp*

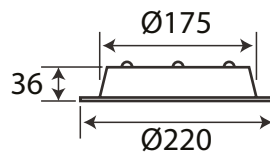

Befestigungsart <i>mounting</i>	Sockelausführung <i>socket version</i>	Anschlussspannung <i>connection voltage</i>	Art.-Nr. <i>Part No.</i>
Einbauversion for built in	BA15s	12/24 V	098 271 092

Zusatzartikel

Produktart <i>product type</i>	Artikeltitel <i>article title</i>	Art.-Nr. <i>Part No.</i>
Lichtscheiben lens	Lichtscheibe lens	098 291 090

LEUCHTMITTEL

ILLUMINANTS





Ⓔ

▪ **H1 Scheinwerferlampe**
Halogen Scheinwerferlampe



▪ **Headlight bulb H1**
halogen lamps

Lampenausführung <i>model type</i>	Sockelausführung <i>socket version</i>	Anschlussleistung <i>connected load</i>	Anschlussspannung <i>connection voltage</i>	OE- Nr. <i>OE- No.</i>	Art.-Nr. <i>Part No.</i>
	P14,5s	55 W	12 V	64150 12258	 091 112 000
+30% Lichtausbeute +30% luminous efficiency	P14,5s	55 W	12 V	64150 Super 12258 PR	 091 112 133
	P14,5s	55 W	12 V	64150 12258	 OSR64150CBI
	P14,5s	70 W	24 V	64155 13258	 OSR64155TSP
	P14,5s	70 W	24 V	64155 13258	 091 124 001
	PGJ13-886	50 W	12 V		 091 212 213

Ⓔ

▪ **H2 Scheinwerferlampe**
Halogen Scheinwerferlampe



▪ **Headlight bulb H1**
halogen lamps

Sockelausführung <i>socket version</i>	Anschlussleistung <i>connected load</i>	Anschlussspannung <i>connection voltage</i>	OE- Nr. <i>OE- No.</i>	Art.-Nr. <i>Part No.</i>
X511	55 W	12 V	64173 12311	 091 212 040
X511	70 W	24 V	64175 13311	 091 224 041

Ⓔ

▪ **H3 Scheinwerferlampe**
Halogen Scheinwerferlampe



▪ **Headlight bulb H3**
halogen lamps

Lampenausführung <i>model type</i>	Sockelausführung <i>socket version</i>	Anschlussleistung <i>connected load</i>	Anschlussspannung <i>connection voltage</i>	OE- Nr. <i>OE- No.</i>	Art.-Nr. <i>Part No.</i>
	PKY22s	100 W	12 V	64153 12455	 091 312 044
	PK22s	55 W	12 V	64151 12336	 091 312 002
Heavy duty	PK22s	55 W	12 V	12356 HD	 091 312 149

Ⓔ

▪ **H3 Scheinwerferlampe**
Halogen Scheinwerferlampe

▪ **Headlight bulb H3**
halogen lamps

Lampenausführung <i>model type</i>	Sockelausführung <i>socket version</i>	Anschlussleistung <i>connected load</i>	Anschlussspannung <i>connection voltage</i>	OE- Nr. <i>OE- No.</i>	Art.-Nr. <i>Part No.</i>
	PK22s	70 W	24 V	64156 13336	 091 324 003
	PK22s	45 W	48 V		 091 348 001
	P14,5s	55 W	12 V	64151 12258	OSR64151NBR
	P14,5s	70 W	24 V	64156 13258	OSR64156TSP

Ⓔ

▪ **H4 Scheinwerferlampe**
Halogen Scheinwerferlampe



▪ **Headlight bulb H4**
halogen lamps

Lampenausführung <i>model type</i>	Sockelausführung <i>socket version</i>	Anschlussleistung <i>connected load</i>	Anschlussspannung <i>connection voltage</i>	OE- Nr. <i>OE- No.</i>	Art.-Nr. <i>Part No.</i>
	P43t	60/55 W	12 V	64193 12342	 091 412 004
	P43t	60/55 W	12 V	64193 Super 12342 PR	 091 412 117
Longlife	P43t	60/55 W	12 V	64193 L 12342 LL	 091 412 168
	P43t	75/70 W	24 V	64196 13342	 091 424 005
Longlife	P43t	75/70 W	24 V	64196 L 13342 LL	 091 424 169
Heavy duty	P43t	75/70 W	24 V	64196 13342 HD	 091 424 070
	P43t	100/90 W	24 V		 091 424 137

Ⓔ

▪ **H7 Scheinwerferlampe**
Halogen Scheinwerferlampe



▪ **Headlight bulb H7**
halogen lamps

Lampenausführung <i>model type</i>	Sockelausführung <i>socket version</i>	Anschlussleistung <i>connected load</i>	Anschlussspannung <i>connection voltage</i>	OE- Nr. <i>OE- No.</i>	Art.-Nr. <i>Part No.</i>
	PX26d	55 W	12 V	64210	 091 172 055
Longlife	PX26d	55 W	12 V	64210 L 12972 LL	 091 172 167



▪ **H7 Scheinwerferlampe**
Halogen Scheinwerferlampe



▪ **Headlight bulb H7**
halogen lamps

Lampenausführung <i>model type</i>	Sockelausführung <i>socket version</i>	Anschlussleistung <i>connected load</i>	Anschlussspannung <i>connection voltage</i>	OE- Nr. <i>OE- No.</i>	Art.-Nr. <i>Part No.</i>
	PX26d	70 W	24 V	64215 13972	 091 174 056
X-Blau X-blue	PX26d	70 W	24 V	64215 CB 13972 BV	 091 174 170
TDL longlife	PX26d	70 W	24 V	64215 13972	 091 174 063

Ⓔ



▪ **HB3/HB4 Scheinwerferlampe**
Halogen Scheinwerferlampe

▪ **Headlight bulb HB3/HB4**
halogen lamps

Sockelausführung <i>socket version</i>	Anschlussleistung <i>connected load</i>	Anschlussspannung <i>connection voltage</i>	OE- Nr. <i>OE- No.</i>	Art.-Nr. <i>Part No.</i>
P20d	65 W	12 V	9005	 091 212 115
P22d	55 W	12 V	9006	 091 212 116



▪ **ECE/SAE Scheinwerferlampe**
Halogen Scheinwerferlampe

▪ **ECE/SAE headlight lamp**
halogen lamps

Sockelausführung <i>socket version</i>	Anschlussleistung <i>connected load</i>	Anschlussspannung <i>connection voltage</i>	Art.-Nr. <i>Part No.</i>
PGJ19-5 H9	65 W	12 V	 091 192 321
PGJ13-886	50 W	12 V	 091 212 213
PGJ13-894	37,5 W	12 V	 091 212 313





▪ **Miniwatt Glühlampen**
Halogen Scheinwerferlampe

▪ **Miniwatt bulbs**
halogen lamps

Sockelausführung <i>socket version</i>	Anschlussleistung <i>connected load</i>	Anschlussspannung <i>connection voltage</i>	OE- Nr. <i>OE- No.</i>	Art.-Nr. <i>Part No.</i>
BA9s	5 W	12 V	64111 12023	 091 612 052
BA9s	10 W	12 V	64113 12024	 091 612 051

▪ **Miniwatt Glühlampen**
Halogen Scheinwerferlampe

▪ **Miniwatt bulbs**
halogen lamps

Sockelausführung <i>socket version</i>	Anschlussleistung <i>connected load</i>	Anschlussspannung <i>connection voltage</i>	OE- Nr. <i>OE- No.</i>	Art.-Nr. <i>Part No.</i>
BA9s	20 W	12 V	64115 12025	 091 612 050
BAX9s	6 W	12 V	64132 12036	 091 612 059
BAY9s	21 W	12 V	64136 12356	 091 612 180
BAY9s	21 W	24 V	64138 24356	 091 624 141

LEUCHTMITTEL
BULBS



**INFORMIEREN SIE SICH
AUCH ÜBER UNSEREN
FAHRZEUGAUSRÜSTUNGSKATALOG**

WWW.RAL.AT







- Ⓔ **Asymmetrische Scheinwerferlampen ECE/SAE Zusatzscheinwerferlampen** **asymmetrical headlight bulbs ECE/SAE additional headlight bulbs**

Sockelausführung <i>socket version</i>	Anschlussleistung <i>connected load</i>	Anschlussspannung <i>connection voltage</i>	OE- Nr. <i>OE- No.</i>	Art.-Nr. <i>Part No.</i>
P45t	45/40 W	12 V	7951 12620	 091 512 006
P45t	55/50 W	24 V	7952 13620	 091 524 007











- Ⓔ **Symmetrische Scheinwerferlampen Zusatzscheinwerferlampen** **symmetrical headlight bulbs additional headlight bulbs**

Sockelausführung <i>socket version</i>	Anschlussleistung <i>connected load</i>	Anschlussspannung <i>connection voltage</i>	OE- Nr. <i>OE- No.</i>	Art.-Nr. <i>Part No.</i>
BA20d	25/25 W	12 V	7326 12718	 091 612 151
BA20d	35/35 W	12 V	7327 12728	 091 612 093
BA20d	45/40 W	12 V	7351 12748	 091 612 122







- Ⓔ **Zusatzscheinwerferlampen** **additional headlight bulbs**

Sockelausführung <i>socket version</i>	Anschlussleistung <i>connected load</i>	Anschlussspannung <i>connection voltage</i>	OE- Nr. <i>OE- No.</i>	Art.-Nr. <i>Part No.</i>
BA15s	25 W	12 V	7582 12325	 091 612 101
BA15s	45 W	12 V	7569 12241	 091 612 136
BA15s	45 W	24 V	7669 13241	 091 624 126
BA20s	45 W	12 V	7301 12247	 091 612 118
BA20s	35 W	24 V	7409 13227	 091 624 091
BA20s	45 W	24 V	7438 13247	 091 624 127

Ⓔ **▪ Blink- und Bremslichtlampen** **▪ flasher and stop light bulbs**
Glühlampe **bulb**

Lampenausführung <i>model type</i>	Sockelausführung <i>socket version</i>	Anschlussleistung <i>connected load</i>	Anschlussspannung <i>connection voltage</i>	OE- Nr. <i>OE- No.</i>	Art.-Nr. <i>Part No.</i>
	BA15s	18 W	12 V	7527 12445	 091 612 060
	BA15s	21 W	12 V	7506 12498	 091 612 010
	BA15s	21 W	24 V	7511 13498	 091 624 011
Heavy duty	BA15s	21 W	24 V	9511 13498 HD	 091 624 071
2-polig 2-pole	BA15d	21 W	12 V	7432 12422	 091 612 105
	BA15s	15 W	24 V	7529 13401	 091 624 124
2-polig 2-pole	BA15d	21 W	24 V	7512 13422	 091 624 159
	BAU15s	21 W	12 V	7507 12496	 091 612 084
	BAU15s	21 W	24 V		 091 624 077
Heavy duty	BAU15s	21 W	24 V	9507 13496	 091 624 078

Ⓔ **▪ Brems- und Schlusslichtlampen** **▪ stop and tail light bulbs**
Glühlampe **bulb**

Sockelausführung <i>socket version</i>	Anschlussleistung <i>connected load</i>	Anschlussspannung <i>connection voltage</i>	OE- Nr. <i>OE- No.</i>	Art.-Nr. <i>Part No.</i>
BAY15d	18/4 W	12 V	7231 12517	 091 612 158
BAZ15d	21/4 W	12 V	7225 12594	 091 612 113
BAY15d	21/5 W	12 V	7528 12499	 091 612 008
BAZ15d	21/4 W	24 V	13498	 091 624 185
BAY15d	21/5 W	24 V	7537 13499	 091 624 009
W2,5x16q	27/7 W	12 V	3157	 091 612 182











Ⓔ

▪ **Anzeige- und Standlichtlampen** ▪ *indicator and parking light bulbs*
Glühlampe *bulb*

Lampenausführung <i>model type</i>	Sockelausführung <i>socket version</i>	Anschlussleistung <i>connected load</i>	Anschlussspannung <i>connection voltage</i>	OE- Nr. <i>OE- No.</i>	Art.-Nr. <i>Part No.</i>
	BA9s	2 W	12 V	3796 12913	 091 712 028
	BA9s	3 W	12 V	3894 12910	 091 712 094
	BA9s	2 W	24 V	3797 19913	 091 724 029
	BA9s	4 W	12 V	3893 12929	 091 712 016
	BA9s	4 W	24 V	3930 13929	 091 724 017
Heavy duty	BA9s	4 W	24 V	9930 HD 13929 HD	 091 724 074
	BA7s	2 W	12 V	3898 12829	 091 712 018
	BA7s	3 W	24 V	3899 13829	 091 724 019

Ⓔ



















▪ **Schlusslicht- und Kennzeichenlampen** ▪ *tail and licence plate light bulbs*
Glühlampe *bulb*

Lampenausführung <i>model type</i>	Sockelausführung <i>socket version</i>	Anschlussleistung <i>connected load</i>	Anschlussspannung <i>connection voltage</i>	OE- Nr. <i>OE- No.</i>	Art.-Nr. <i>Part No.</i>
	BA15s	5 W	12 V	5007 12821	 091 612 014
	BA15s	10 W	12 V	5008 12814	 091 612 012
2-polig 2-pole	BA15d	5 W	12 V	5407 12822	 091 612 092
	BA15s	5 W	24 V	5627 13821	 091 624 015
Heavy duty	BA15s	5 W	24 V	9627HD 13821 HD	 091 624 075
	BA15s	10 W	24 V	5637 13814	 091 624 013
Heavy duty	BA15s	10 W	24 V	9637HD 13814 HD	 091 624 072
2-polig 2-pole	BA15d	5 W	24 V	5626 13822	 091 624 125

Ⓔ

▪ Soffittenlampe
Glühlampe

▪ festoon bulbs
bulb

Länge length	Lampendurchmesser lamp diameter	Sockelausführung socket version	Anschlussleistung connected load	Anschlussspannung connection voltage	OE- Nr. OE- No.		Art.-Nr. Part No.
27 mm	11 mm	SV8,5-36	10 W	12 V	6438 12860		091 812 130
28 mm	8 mm	SV7,0-8	3 W	12 V	6428 12842		091 812 068
33 mm	6.5 mm	SV5,5	3 W	12 V	6439 12849		091 812 131
36 mm	11 mm	SV8,5-36	5 W	12 V	6418 12844		091 812 026
36 mm	11 mm	SV8,5-36	10 W	12 V	6461 12854		091 812 064
41 mm	11 mm	SV8,5-36	5 W	12 V	6413 12864		091 812 066
41 mm	11 mm	SV8,5-36	10 W	12 V	6411 12866		091 812 024
41 mm	15 mm	SV8,5-36	15 W	12 V	6451 12850		091 812 111
41 mm	15 mm	SV8,5-36	18 W	12 V	6475 12807		091 812 031
41 mm	15 mm	SV8,5-36	21 W	12 V	6476 12803		091 812 035
28 mm	8 mm	SV7,0-8	3 W	24 V	6430 13842		091 824 069
33 mm	6.5 mm	SV5,5	3 W	24 V	6444 13849		091 824 132
36 mm	11 mm	SV8,5-36	5 W	24 V	6423 13844		091 824 027
36 mm	11 mm	SV8,5-36	10 W	24 V	13854		091 824 065
41 mm	11 mm	SV8,5-36	5 W	24 V	6424 13864		091 824 067
41 mm	11 mm	SV8,5-36	10 W	24 V	6429 13866		091 824 025
41 mm	15 mm	SV8,5-36	15 W	24 V	6453 13850		091 824 112
41 mm	15 mm	SV8,5-36	18 W	24 V	6480 13807		091 824 032



Ⓔ

▪ Reflektorlampen zweipolig
Glühlampe

▪ reflector bulbs, 2-poled
bulb

Sockelausführung socket version	Anschlussleistung connected load	Anschlussspannung connection voltage	OE- Nr. OE- No.	Art.-Nr. Part No.
REF 29	1,4 W	24 V	655 544 0094	 091 724 201
REF 9	2,4 W	24 V	307 544 0094	 091 724 202

Ⓔ

▪ Glassockellampen
Glühlampe

▪ glass socket bulbs
bulb

Farbe colour	Sockelausführung socket version	Anschlussleistung connected load	Anschlussspannung connection voltage	OE- Nr. OE- No.	Art.-Nr. Part No.
	W2,0x4,6d	2,3 W	12 V	2723 12061	 091 712 175
	W2,0x4,6d	2 W	24 V	2061	 091 724 150
	W2,0x4,6d	1 W	24 V	2341 13521	 091 724 155
	W2,0x4,6d	1,2 W	12 V	2721 12516	 091 712 022
	W2,0x4,6d	1,2 W	24 V	2741 13516	 091 724 023
	W2,1x9,5d	2 W	12 V	2820 12960	 091 712 128
	W2,1x9,5d	3 W	12 V	2821 12256	 091 712 020
	W2,1x9,5d	5 W	12 V	2825 12961	 091 712 033
orange amber	W2,1x9,5d	5 W	12 V	2827 12396	 091 712 085
	W2,1x9,5d	6 W	12 V	2886 X 12040	 091 712 176
	W2,1x9,5d	2 W	24 V	2840 13960	 091 724 095
	W2,1x9,5d	3 W	24 V	2841 13256	 091 724 021
	W2,1x9,5d	5 W	24 V	2845 13961	 091 724 036
	W2,1x9,5d	16 W	12 V	921 12067	 091 612 177

Ⓔ **Glassockellampen für japanische Fahrzeuge** **Glühlampe** **glass socket bulbs for japanese vehicles bulb**

Sockelausführung socket version	Anschlussleistung connected load	Anschlussspannung connection voltage	OE- Nr. OE- Nr.	Art.-Nr. Part No.
W3x16d	21 W	12 V		091 612 153
W3x16q	21/5 W	12 V	7515	091 612 154





Ⓔ **Kunststoffsockellampen** **Glühlampe** **plastic socket lamps bulb**

Sockelfarbe holder colour	Stromstärke amperage	Sockelausführung socket version	Anschlussleistung connected load	Anschlussspannung connection voltage	Glasfarbe glass colour	OE- Nr. OE- Nr.	Art.-Nr. Part No.
grün green	0.06 A	EBS R11	1,4 W	24 V	weiß white		091 724 208
gelb yellow	0.0004 A	EBS R4	1,0 W	24 V	weiß white	7440 6500	091 724 096
braun brown	0.0005 A	EBS R6	1,0 W	24 V	weiß white	7421	091 724 097
weiß white	0.053 A	EBS R10	1,0 W	24 V	weiß white		091 724 207
orange amber		BX8,4d	1,1 W	12 V	weiß white	2473MFX6	091 712 188
schwarz black	0.09 A	BX8,4d	1,2 W	12 V	weiß white	EBS P19 2351MFX6	091 712 147
dunkelgrün dark green		BX8,4d	1,3 W	12 V	weiß white	2431MFX6	091 712 186
beige beige		BX8,4d	1,5 W	12 V	weiß white	2452MFX6	091 712 098
hellgrün light green		BX8,4d	2,0 W	12 V	weiß white	2352MFX6	091 712 187
grau grey	0.06 A	EBS N1 BAX10d	1,2 W	24 V	weiß white		091 724 204
		W2,0x4,6d	1 W	24 V		13521	091 724 129



▪ **Miniwatt
Kunststoffsockellampen
Glühlampe**

▪ *Miniwatt plastic socket lamps
bulb*

Sockelfarbe holder colour	Sockelausführung socket version	Anschlussleistung connected load	Anschlussspannung connection voltage	OE- Nr. OE- No.		Art.-Nr. Part No.
schwarz black	B8,5d BAX10d	1,2 W	12 V	2721MF 12598		091 712 034
hellblau light blue	BX8,5d	1,2 W	12 V	2721MFX 12603		091 712 191
beige beige	B8,5d	1,2 W	12 V	2752MF		091 712 190
grün green	BAX10d	1,2 W	12 V	2722MF 12600		091 712 099
hellgrau light grey	BAX10d	1,2 W	24 V	2741MF 13598		091 724 030
kupferbraun copper brown	BX8,5d	1,2 W	24 V	2741MFX		091 724 104
schwarz black	B8,3d BAX10s	1,2 W	12 V	2721MF8 12603		091 712 037
weiß white	B8,3d BAX10s	2,0 W	12 V	2722MF8		091 712 039
grau grey	B8,3d BAX10s	1,2 W	24 V	2741MF8 12600		091 724 038
grau grey	B8,7d	1,2 W	12 V	2721MF8W		091 712 146
grün green	BX8,7d	2,0 W	12 V	2722MF8W		091 712 100





















E

▪ LED-Lampen

▪ LED-bulbs

Im Geltungsbereich der StVo nicht
zulässig

Not for use in european public traffic

Leuchtmittelfarbe <i>lamp colour</i>	Sockelausführung <i>socket version</i>	Anschlussleistung <i>connected load</i>	Anschlussspannung <i>connection voltage</i>	LED Anzahl <i>LED number</i>	Art.-Nr. <i>Part No.</i>
gelb yellow	BA15s	0,5 W	12 V	5	 092 612 216
rot red	BA15s	0,5 W	12 V	5	 092 612 116
weiß white	BA15s	0,5 W	12 V	5	 092 612 016
weiß white	BA15s	0,5 W	24 V	5	 092 624 017
gelb yellow	BA15s	0,5 W	24 V	5	 092 624 217
rot red	BA15s	0,5 W	24 V	5	 092 624 117
rot red	BAY15d	1,6 W	12 V	19	 092 612 109
rot red	BAY15d	1,6 W	24 V	19	 092 624 110
weiß white	BA15s	1,7 W	12 V	19	 092 612 011
weiß white	BA15s	1,4 W	24 V	19	 092 624 012
rot red	BA15s	1,7 W	12 V	19	 092 612 111
rot red	BA15s	1,4 W	24 V	19	 092 624 112
gelb yellow	BA15s	1,7 W	12 V	19	 092 612 211
gelb yellow	BA15s	1,4 W	24 V	19	 092 624 212
weiß white	BA9s	0,29 W	12 V	1	 092 712 017
weiß white	BA9s	0,29 W	12 V	1	 092 724 018
weiß white	W2,1x9,5d	0,28 W	12 V	1	 092 712 032
weiß white	W2,1x9,5d	0,42 W	12 V	1	 092 724 037



Ⓔ

▪ LED-Lampen

▪ LED-bulbs

Leuchtmittelfarbe lamp colour	Sockelausführung socket version	Anschlussleistung connected load	Anschlussspannung connection voltage	LED Anzahl LED number	Art.-Nr. Part No.
weiß white	SV8,5	0,5 W	24 V	6	092 812 027
weiß white	SV8,5	0,7 W	24 V	6	092 824 028
weiß white	SV8,5	0,6 W	12 V	8	092 812 025
weiß white	SV8,5	0,7 W	24 V	8	092 824 026



BEACHTEN SIE UNSERE
LAUFENDEN AKTIONEN
IN UNSEREN FILIALEN
UND AUF
WWW.RAL.AT



Ⓔ

▪ Xenon Gasentladungslampe
Xenon Lampen

▪ *xenon gaseous-discharge
headlight bulbs
Xenon bulbs*

Sockelausführung <i>socket version</i>	Anschlussleistung <i>connected load</i>	Anschlussspannung <i>connection voltage</i>	OE- Nr. <i>OE- No.</i>	Art.-Nr. <i>Part No.</i>
PK32d-3	35 W	85 V	66154 85409	 091 900 032
PK32d-2	35 W	85 V	66144 8GS 009 028-021	 091 900 031
P32d-2	35 W	85 V	66040 85122	 091 900 021
P32d-3	35 W	85 V	66050 85126	 091 900 022
	35 W	12/24 V		 091 900 036

LEUCHTMITTEL
BULBS



Stecksocket
Zubehör

sockets
accessories

OE- Nr. OE- No.			Art.-Nr. Part No.
8JA 990 065-001	Stecksocket H4 Glühlampe für Flachsteckhülse socket for H4 bulbs for receptacle		098 191 942
1 304 485 401	Stecksocket H4 Glühlampe für Flachsteckhülse socket for H4 bulbs for receptacle		099 855 280
8KB 863 949-011	Stecksocket H7 Glühlampe für Flachsteckhülse socket for H7 bulbs for receptacle		099 855 282



Art.-Nr. / Part No.	Seite / page	Art.-Nr. / Part No.	Seite / page	Art.-Nr. / Part No.	Seite / page	Art.-Nr. / Part No.	Seite / page
090 147 714	248	091 624 126	352	091 900 021	361	098 081 339	39-40
090 450 995	122	091 624 127	352	091 900 022	361	098 082 001	24
091 112 000	348	091 624 141	351	091 900 031	361	098 082 002	24
091 112 133	348	091 624 159	353	091 900 032	361	098 082 005	25
091 124 001	348	091 624 185	353	091 900 036	361	098 082 006	25
091 172 055	349	091 712 016	354	092 612 011	359	098 082 009	30
091 172 167	349	091 712 018	354	092 612 016	359	098 082 010	28
091 174 056	350	091 712 020	356	092 612 109	359	098 082 011	30
091 174 063	350	091 712 022	356	092 612 111	359	098 082 012	28
091 174 170	350	091 712 028	354	092 612 116	359	098 083 005	14
091 192 321	350	091 712 033	356	092 612 211	359	098 083 006	14
091 212 040	348	091 712 034	358	092 612 216	359	098 084 382	12
091 212 115	350	091 712 037	358	092 624 012	359	098 084 383	12
091 212 116	350	091 712 039	358	092 624 017	359	098 089 190	62
091 212 213	348,350	091 712 085	356	092 624 110	359	098 089 290	12
091 212 313	350	091 712 094	354	092 624 112	359	098 089 291	12
091 224 041	348	091 712 098	357	092 624 117	359	098 089 335	58
091 312 002	348	091 712 099	358	092 624 212	359	098 089 336	58
091 312 044	348	091 712 100	358	092 624 217	359	098 103 315	23
091 312 149	348	091 712 128	356	092 712 017	359	098 103 325	22
091 324 003	349	091 712 146	358	092 712 032	359	098 103 330	23
091 348 001	349	091 712 147	357	092 724 018	359	098 104 170	51
091 412 004	349	091 712 175	356	092 724 037	359	098 105 115	52
091 412 117	349	091 712 176	356	092 812 025	360	098 105 124	49
091 412 168	349	091 712 186	357	092 812 027	360	098 105 190	51
091 424 005	349	091 712 187	357	092 824 026	360	098 105 444	48
091 424 070	349	091 712 188	357	092 824 028	360	098 105 472	53
091 424 137	349	091 712 190	358	098 018 360	17	098 105 473	53
091 424 169	349	091 712 191	358	098 018 361	17	098 106 976	11
091 512 006	352	091 724 017	354	098 055 003	57	098 106 977	11
091 524 007	352	091 724 019	354	098 055 004	57	098 109 000	47
091 612 008	353	091 724 021	356	098 055 092	59	098 109 001	47
091 612 010	353	091 724 023	356	098 055 094	58	098 109 010	47
091 612 012	354	091 724 029	354	098 055 096	60	098 109 020	47
091 612 014	354	091 724 030	358	098 055 098	61	098 109 021	47
091 612 050	351	091 724 036	356	098 055 117	9	098 109 030	48
091 612 051	350	091 724 038	358	098 055 118	9	098 109 093	31-36
091 612 052	350	091 724 074	354	098 055 202	67	098 109 700	6
091 612 059	351	091 724 095	356	098 055 203	67	098 109 701	6
091 612 060	353	091 724 096	357	098 055 204	66	098 109 702	7
091 612 084	353	091 724 097	357	098 055 205	66	098 109 703	7
091 612 092	354	091 724 104	358	098 055 315	10	098 109 704	14
091 612 093	352	091 724 129	357	098 055 316	10	098 109 705	14
091 612 101	352	091 724 150	356	098 056 500	6	098 109 708	11-12
091 612 105	353	091 724 155	356	098 056 501	6	098 109 709	11-12
091 612 113	353	091 724 201	356	098 056 502	7	098 109 710	7
091 612 118	352	091 724 202	356	098 056 503	7	098 109 836	41-42
091 612 122	352	091 724 204	357	098 056 504	7	098 109 837	41-42
091 612 136	352	091 724 207	357	098 056 505	7	098 109 840	43-46
091 612 151	352	091 724 208	357	098 056 790	8	098 109 841	43-46
091 612 153	357	091 812 024	355	098 056 791	8	098 109 965	21
091 612 154	357	091 812 026	355	098 069 715	13	098 109 966	21
091 612 158	353	091 812 031	355	098 069 716	13	098 109 969	21,102
091 612 177	356	091 812 035	355	098 076 113	41	098 109 980	21-22
091 612 180	351	091 812 064	355	098 076 114	41	098 109 981	21-22
091 612 182	353	091 812 066	355	098 076 200	43	098 110 001	24-27
091 624 009	353	091 812 068	355	098 076 201	43	098 110 002	24-27
091 624 011	353	091 812 111	355	098 076 210	44	098 110 003	24-27
091 624 013	354	091 812 130	355	098 076 211	44	098 110 004	24-27
091 624 015	354	091 812 131	355	098 076 220	45	098 110 005	29-30
091 624 071	353	091 824 025	355	098 076 221	45	098 110 006	29-30
091 624 072	354	091 824 027	355	098 076 230	46	098 120 144	49
091 624 075	354	091 824 032	355	098 076 231	46	098 120 146	49
091 624 077	353	091 824 065	355	098 081 117	31	098 120 150	52
091 624 078	353	091 824 067	355	098 081 118	31	098 120 186	52
091 624 091	352	091 824 069	355	098 081 334	38	098 121 130	50
091 624 124	353	091 824 112	355	098 081 335	38	098 128 150	54
091 624 125	354	091 824 132	355	098 081 338	39-40	098 128 505	54



Art.-Nr. / Part No.	Seite / page	Art.-Nr. / Part No.	Seite / page	Art.-Nr. / Part No.	Seite / page	Art.-Nr. / Part No.	Seite / page
098 128 515	54	098 210 390	163	098 212 840	113	098 213 168	126
098 142 110	74	098 210 840	176	098 212 843	113	098 213 171	126
098 142 140	75	098 210 845	176	098 212 845	113	098 213 180	149
098 142 145	76	098 211 135	175	098 212 848	113	098 213 190	149
098 142 150	74	098 212 120	170	098 212 855	115	098 213 220	128
098 142 155	75	098 212 125	170	098 212 865	115	098 213 230	128
098 142 180	73	098 212 140	162	098 212 880	197	098 213 341	141
098 143 910	70-71	098 212 145	162	098 212 881	197	098 213 346	145
098 143 920	70-71	098 212 150	162	098 212 882	197	098 213 351	141
098 148 184	61	098 212 152	162	098 212 890	122	098 213 356	145
098 148 185	61	098 212 159	171	098 212 891	122	098 213 361	146
098 148 221	56	098 212 160	170	098 212 892	122	098 213 366	145
098 148 222	56	098 212 162	170	098 212 893	140	098 213 371	146
098 148 223	56	098 212 170	161	098 212 894	140	098 213 381	148
098 148 224	56	098 212 171	161	098 212 895	129	098 213 391	148
098 148 225	57	098 212 172	161	098 212 896	129	098 213 400	147
098 148 226	57	098 212 173	161	098 212 897	129	098 213 405	147
098 148 991	65	098 212 174	160	098 212 900	120,137	098 213 410	147
098 148 992	65	098 212 175	160	098 212 901	120,137	098 213 511	142
098 150 021	46	098 212 176	159	098 212 902	120,137	098 213 516	142
098 150 022	46	098 212 177	159	098 212 903	111	098 213 521	142
098 151 001	62	098 212 178	160	098 212 904	111	098 213 610	144
098 152 100	74	098 212 179	160	098 212 905	111	098 213 612	144
098 153 001	68	098 212 180	152	098 212 906	111	098 213 630	196
098 153 002	68	098 212 190	163	098 212 907	111	098 213 632	196
098 153 016	71	098 212 220	156	098 212 908	111	098 214 052	117
098 153 026	71	098 212 230	156	098 212 910	110,136,155,177	098 214 053	117
098 153 334	67	098 212 340	173	098 212 912	110,136,155,177	098 214 055	118
098 153 335	67	098 212 342	167	098 212 914	178	098 214 056	118
098 153 336	68	098 212 344	167	098 212 916	178	098 214 210	207
098 153 337	68	098 212 352	169	098 212 920	198	098 214 220	207
098 191 942	362	098 212 356	169	098 212 921	177	098 214 230	208
098 192 972	222	098 212 357	165	098 212 922	198	098 214 240	208
098 193 958	222	098 212 367	166	098 212 923	177	098 214 260	205
098 200 291	244	098 212 368	166	098 212 953	108,124	098 214 270	205
098 200 422	238	098 212 372	168	098 212 954	109,124	098 214 290	205
098 200 424	238	098 212 374	168	098 212 956	109,121	098 214 440	134
098 200 800	80	098 212 451	159	098 212 957	109,121	098 214 465	132
098 200 975	241	098 212 461	159	098 212 961	116	098 214 475	132
098 201 393	243	098 212 532	202	098 212 962	116	098 214 530	139
098 201 454	244	098 212 533	202	098 212 963	127	098 214 535	139
098 201 458	245	098 212 534	203	098 212 964	127	098 214 540	139
098 201 552	242	098 212 535	203	098 212 972	154	098 214 545	139
098 201 873	239	098 212 536	200	098 212 974	154	098 214 560	138
098 201 875	239	098 212 537	200	098 212 983	114	098 214 570	138
098 203 036	235	098 212 538	201	098 212 984	114	098 214 580	138
098 203 039	154	098 212 539	201	098 212 985	114	098 215 017	191
098 203 049	142	098 212 540	177	098 212 986	114	098 215 019	191
098 203 059	142	098 212 561	157	098 212 991	116	098 215 026	191
098 203 400	240	098 212 571	157	098 212 992	116	098 215 027	191
098 203 422	236	098 212 610	177	098 212 993	116	098 215 028	191
098 203 501	240	098 212 630	164	098 212 994	116	098 215 029	191
098 203 505	240	098 212 711	131,206	098 213 010	158	098 215 031	179
098 203 510	165	098 212 721	131,206	098 213 020	158	098 215 032	179
098 203 521	238	098 212 731	152	098 213 031	150	098 215 034	179
098 203 601	239	098 212 736	152	098 213 032	150	098 215 035	184
098 203 605	239	098 212 741	152	098 213 035	150	098 215 036	184
098 204 492	241	098 212 751	152	098 213 036	150	098 215 038	184
098 205 038	230	098 212 754	178	098 213 041	143	098 215 100	181
098 205 088	235	098 212 756	153	098 213 042	143	098 215 102	181
098 206 530	164	098 212 758	153	098 213 043	143	098 215 103	181
098 208 402	242	098 212 761	178	098 213 044	143	098 215 104	181
098 210 320	173	098 212 764	178	098 213 141	133	098 215 110	181
098 210 325	173	098 212 770	108,119	098 213 151	133	098 215 112	181
098 210 330	175	098 212 806	109	098 213 161	126	098 215 120	182
098 210 335	175	098 212 807	109	098 213 162	126	098 215 122	182
098 210 360	174,248	098 212 830	112	098 213 163	126	098 215 130	180
098 210 361	174,248	098 212 835	112	098 213 167	126	098 215 132	180



Art.-Nr. / Part No.	Seite / page	Art.-Nr. / Part No.	Seite / page	Art.-Nr. / Part No.	Seite / page	Art.-Nr. / Part No.	Seite / page
098 215 200	192	098 221 216	259	098 222 230	297	098 230 050	78
098 215 210	192	098 221 225	252-253	098 222 231	297	098 230 108	82
098 215 220	192	098 221 228	263	098 222 317	281	098 230 290	93
098 215 230	192	098 221 245	251	098 222 318	281	098 230 297	95
098 215 381	146	098 221 250	261	098 222 321	282	098 230 422	87
098 215 391	146	098 221 252	271	098 222 322	282	098 230 424	87
098 215 431	188	098 221 254	272	098 222 323	280	098 230 501	84
098 215 434	188	098 221 256	272	098 222 324	280	098 230 505	84
098 215 435	188	098 221 265	257	098 222 400	11,285	098 230 523	86
098 215 438	188	098 221 290	256	098 222 410	11,285	098 230 562	85
098 215 500	182	098 221 293	267	098 222 417	283	098 230 563	85
098 215 501	182	098 221 295	256	098 222 418	283	098 230 601	84
098 215 510	210	098 221 305	269	098 222 500	306	098 230 605	84
098 215 511	210	098 221 350	267	098 222 630	303	098 230 610	79
098 215 520	182	098 221 352	267	098 222 802	294	098 230 800	89
098 215 521	183	098 221 354	263	098 222 805	15,291	098 230 805	89
098 215 530	211	098 221 357	253-254	098 222 808	291	098 230 960	86
098 215 531	211	098 221 370	250	098 222 830	290	098 230 961	86
098 215 630	171	098 221 372	255	098 222 850	280	098 230 964	86
098 215 631	171	098 221 376	251	098 223 001	296	098 231 374	243
098 215 632	171	098 221 377	258	098 223 002	296	098 231 381	78
098 215 633	171	098 221 381	258	098 223 005	295	098 231 391	94
098 215 634	172	098 221 383	268	098 223 007	295	098 231 395	95
098 215 635	172	098 221 385	276	098 223 009	296	098 231 452	96
098 215 636	172	098 221 386	277	098 223 010	296	098 231 459	96
098 215 637	172	098 221 391	266	098 223 013	298	098 231 551	90
098 215 740	193	098 221 393	275	098 223 014	299	098 231 820	97
098 215 745	193	098 221 395	275	098 223 015	299	098 231 873	85
098 215 750	195	098 221 397	250	098 223 016	287-288	098 231 875	85
098 215 751	195	098 221 400	259	098 223 017	287-288	098 232 080	90
098 215 752	195	098 221 422	264	098 223 020	289	098 232 373	91
098 215 753	195	098 221 424	264	098 223 021	289	098 233 051	81
098 215 754	194	098 221 426	273	098 223 022	287	098 233 053	82
098 215 755	194	098 221 428	273	098 223 023	287	098 233 302	83
098 215 756	194	098 221 450	308	098 223 037	300	098 233 304	83
098 215 757	194	098 221 500	262	098 223 038	300	098 233 305	82
098 215 760	199	098 221 501	262	098 223 042	297	098 233 306	82
098 215 761	199	098 221 502	262	098 223 043	297	098 233 400	97
098 215 762	199	098 221 512	240	098 223 046	298	098 234 491	89
098 215 763	199	098 221 514	88	098 223 047	298	098 236 220	92
098 215 890	123	098 221 525	262	098 223 048	299	098 236 222	93
098 215 891	123	098 221 550	307	098 223 050	102	098 236 794	92
098 215 900	130	098 221 601	259	098 223 058	299	098 236 827	284
098 215 901	130	098 221 605	259	098 223 060	7,279	098 236 829	284
098 215 910	112	098 221 611	269	098 223 061	6,279	098 239 991	88
098 215 911	112	098 221 615	269	098 223 062	280	098 241 016	310
098 215 920	112	098 221 701	255	098 223 070	286	098 241 026	325
098 215 921	112	098 221 704	255	098 223 075	287	098 241 030	312
098 215 953	124	098 221 705	255	098 223 426	300	098 241 031	312
098 215 954	124	098 221 835	285	098 223 920	283	098 241 034	312
098 216 014	176	098 221 836	286	098 223 930	283	098 241 035	312
098 216 500	183	098 221 837	279	098 224 300	305	098 241 036	312
098 216 501	183	098 221 838	284	098 224 490	305	098 241 037	312
098 217 350	151	098 221 850	264	098 225 084	301	098 241 065	311
098 217 351	151	098 221 852	274	098 225 530	303	098 241 075	326
098 218 270	105	098 221 854	274	098 225 700	304	098 241 086	325
098 218 271	105	098 221 874	263	098 226 092	302	098 241 110	320
098 221 066	301	098 221 876	263	098 226 094	302	098 241 120	329
098 221 075	302	098 221 884	263	098 226 530	304	098 241 160	321
098 221 161	301	098 221 896	263	098 226 535	304	098 241 170	331
098 221 171	302	098 221 940	261	098 227 020	104	098 241 180	330
098 221 204	265	098 221 941	261	098 227 470	307	098 241 190	315
098 221 209	260	098 221 942	273	098 227 471	307	098 241 210	242
098 221 211	260	098 221 943	273	098 228 400	306	098 241 230	322
098 221 212	266	098 221 944	261	098 230 010	79	098 241 233	331
098 221 213	266	098 222 130	105	098 230 020	81	098 241 236	332
098 221 214	270	098 222 140	103	098 230 030	81	098 241 241	311
098 221 215	270	098 222 190	104	098 230 040	78	098 241 244	326



Art.-Nr. / Part No.	Seite / page	Art.-Nr. / Part No.	Seite / page	Art.-Nr. / Part No.	Seite / page	Art.-Nr. / Part No.	Seite / page
098 241 247	327	098 256 172	225	098 274 230	341	098 291 389	268,276-277
098 241 248	328	098 256 174	225	098 274 406	341	098 291 397	243
098 241 249	327	098 256 200	222	098 274 418	341	098 291 398	94-95
098 241 280	322	098 256 214	223	098 274 430	341	098 291 452	245
098 241 281	322	098 256 220	228	098 274 600	342	098 291 457	308
098 241 282	313	098 256 221	228	098 274 610	342	098 291 458	244
098 241 283	313	098 256 222	228	098 274 620	342	098 291 459	96
098 241 292	332	098 256 230	228	098 274 630	342	098 291 510	279,284-286,289
098 241 297	313	098 256 231	228	098 274 640	343	098 291 949	86,261,273
098 241 310	200-201,317	098 256 232	228	098 274 645	343	098 292 089	90
098 241 312	317	098 256 309	226	098 274 650	343	098 292 132	105
098 241 314	317	098 256 343	226	098 274 652	343	098 292 222	156
098 241 316	317	098 256 345	226	098 275 008	340	098 292 342	173
098 241 320	318	098 256 500	100	098 275 012	339	098 292 354	169
098 241 322	318	098 256 510	227	098 275 016	340	098 292 358	165-168,193
098 241 324	318	098 256 512	224	098 275 026	340	098 292 359	165,167-169
098 241 326	318	098 256 520	99	098 275 076	345		226,232
098 241 330	317	098 256 524	224	098 275 077	345	098 292 360	170
098 241 332	318	098 256 530	99	098 290 000	47,53	098 292 365	162,170
098 241 334	317	098 257 033	230	098 290 001	47,53	098 292 369	166,226,232
098 241 336	318	098 257 034	222	098 290 002	47,53	098 292 463	159
098 241 350	324	098 257 072	231	098 290 038	230	098 292 500	183,210-211
098 241 352	333	098 257 074	231	098 290 056	221	098 292 501	183,210-211
098 241 354	334	098 257 307	232	098 290 088	235	098 292 510	183,210-211
098 241 420	315	098 257 308	232	098 290 299	95,267	098 292 511	183,210-211
098 241 455	314	098 257 347	232	098 290 848	176	098 292 512	204
098 241 490	315	098 257 349	232	098 290 849	176	098 292 513	204
098 241 500	314	098 257 524	231	098 291 005	24-27	098 292 514	200-203
098 241 815	323	098 257 530	231	098 291 012	310,325	098 292 515	200-203
098 242 003	323	098 259 804	248	098 291 016	310,325	098 292 542	177
098 242 820	79	098 259 820	247	098 291 062	311,326	098 292 573	157
098 242 901	80	098 259 822	247	098 291 064	311,326	098 292 612	177
098 242 910	97	098 267 610	248	098 291 066	301-302	098 292 715	131,206
098 246 880	324	098 271 044	344	098 291 090	344,346	098 292 719	336
098 254 096	216	098 271 050	337	098 291 119	301-302	098 292 753	153,178
098 254 111	217	098 271 051	337	098 291 124	320,329-330	098 292 773	108,119
098 254 112	217	098 271 052	337	098 291 125	320,329-330	098 292 775	109,153,178
098 254 114	215	098 271 053	337	098 291 126	320,329-330	098 292 793	109,116,121
098 254 115	215	098 271 054	337	098 291 128	320,329-330		124,127,132
098 254 116	215	098 271 055	337	098 291 129	320,329-330	098 292 842	113
098 254 117	215	098 271 059	341	098 291 132	175	098 292 847	113
098 254 161	217	098 271 060	341	098 291 166	301-302,321,331	098 292 852	115
098 254 166	219	098 271 061	342	098 291 167	301-302	098 292 862	115
098 254 170	216	098 271 062	342	098 291 168	321,331	098 292 888	197
098 254 171	216	098 271 063	342	098 291 169	321,331	098 292 889	197
098 254 180	218	098 271 064	342	098 291 205	91,265	098 292 896	129,140
098 254 230	216	098 271 066	342	098 291 211	266	098 292 897	129,140
098 254 242	214	098 271 067	342	098 291 221	322,331-332	098 292 898	122
098 254 243	215	098 271 073	338	098 291 223	322,331-332	098 292 899	122
098 254 244	214	098 271 081	344	098 291 225	322,331-332	098 292 900	130
098 254 245	214	098 271 092	346	098 291 230	261,264,271- 272,274	098 292 901	130
098 254 246	215	098 271 125	345			098 292 903	120,137
098 254 247	214	098 271 170	346	098 291 233	122-123,193	098 292 912	165-168
098 254 248	215	098 271 718	336	098 291 250	311,326-328	098 292 919	110,114
098 254 249	215	098 271 722	336	098 291 251	311,326-328	098 292 924	165-168
098 255 056	221	098 271 724	336	098 291 266	257	098 292 928	198
098 256 011	99	098 271 732	339	098 291 278	85,263	098 292 929	198
098 256 013	233	098 271 734	339	098 291 300	179-180,182	098 292 933	155
098 256 015	227	098 271 742	339		184,187,189-191	098 292 959	109,116, 124-125,127
098 256 032	233	098 271 744	339		209		132,154
098 256 034	224	098 272 382	346	098 291 353	324,333-334	098 292 973	154
098 256 036	224	098 272 384	346	098 291 356	83,267	098 293 014	102
098 256 040	223	098 274 086	338	098 291 357	267	098 293 015	102
098 256 044	221	098 274 096	338	098 291 358	267	098 293 016	299
098 256 050	230	098 274 132	340	098 291 372	250-251	098 293 017	299
098 256 054	221	098 274 134	340	098 291 375	250-251	098 293 018	289
098 256 072	225	098 274 206	341	098 291 378	258	098 293 022	289
098 256 074	225	098 274 218	341	098 291 381	78,258		







Art.-Nr. / Part No.	Seite / page	Art.-Nr. / Part No.	Seite / page	Art.-Nr. / Part No.	Seite / page	Art.-Nr. / Part No.	Seite / page
098 293 023	289	099 110 741	258	198 103 130	21	298 081 510	41
098 293 024	287-288	099 110 743	298	198 103 140	21	298 081 530	41
098 293 025	287-288	099 111 032	9-10	198 103 150	22	298 081 540	41
098 293 163	126,133	099 111 106	118	198 103 160	22	298 082 003	27
098 293 182	125,149	099 111 116	46,71-72,254	198 106 974	10	298 082 004	27
098 293 223	128		297-298	198 106 975	10	298 082 005	26
098 293 309	252-253,263,267	099 111 410	251,255,294	198 109 832	37-38	298 082 006	26
098 293 323	141,145	099 111 439	251,255,294	198 109 833	37-38	298 082 007	29
098 293 333	141,145	099 111 481	126	198 109 834	31-36	298 082 008	29
098 293 363	146,148	099 111 485	140	198 109 835	31-36	298 082 009	30
098 293 400	147	099 111 493	109-110,117,120	198 109 836	41	298 082 011	30
098 293 513	142		133-135,137	198 109 837	41	298 143 011	70
098 293 523	142		145-146,155,172	198 109 838	39-40	298 143 021	70
098 293 611	144		193-195,197-199	198 109 839	39-40	298 143 050	65
098 293 613	144	099 111 648	16-17,109	198 109 867	15	298 143 051	65
098 293 631	196		122-123,125	198 109 868	15	298 153 003	69
098 293 633	196		129-130	198 109 880	16-17	298 153 004	69
098 294 055	117	099 111 672	63-65	198 109 881	16-17	298 153 005	69
098 294 212	207	099 111 686	290,292-294	198 109 885	18-20,65	298 153 006	69
098 294 232	208	099 111 688	290,292-294	198 109 886	18-20,65	298 153 007	69
098 294 292	205	099 111 689	290,292-294	198 148 338	63	298 153 008	69
098 294 498	241	099 111 800	201,203-204	198 148 339	63	298 153 056	72
098 294 499	89	099 855 280	49,362	198 153 056	71	298 153 070	73
098 294 580	138	099 855 282	362	198 153 066	72	298 153 156	72
098 295 016	191	099 868 407	95,268,276-277	198 153 156	71	298 153 170	73
098 295 030	179,184	198 018 289	15	198 153 166	72	298 222 791	63
098 295 037	184,322,332	198 018 290	15	198 212 530	204	298 222 792	63
098 295 039	184	198 018 347	16	198 212 531	204	298 222 793	64
098 295 076	162,192	198 018 348	16	198 214 445	134	298 222 794	64
098 295 078	162,192	198 018 351	17	198 214 450	134	298 223 042	297
098 295 150	180,182	198 018 352	17	198 214 455	134	298 223 043	297
098 296 015	176	198 054 315	8	198 214 510	135	398 018 200	20
098 296 221	93	198 054 316	8	198 214 515	135	398 018 201	20
098 296 225	93,266	198 055 096	60	198 214 520	135	398 018 202	19
098 296 889	324	198 055 098	61	198 221 265	257	398 018 203	19
098 297 015	269	198 055 102	60-61	198 221 357	253-254	398 018 204	19
098 297 017	269	198 055 103	60-61	198 221 381	258	398 018 205	19
098 297 260	151	198 055 313	9	198 222 789	64	398 018 291	15
098 297 300	54	198 055 314	9	198 222 790	64	398 018 292	15
098 297 352	151	198 076 313	42	198 222 791	63	398 109 885	18-20
098 297 353	151	198 076 314	42	198 222 792	63	398 109 886	18-20
098 298 407	306	198 076 323	42	198 222 801	292	398 148 338	63
098 299 809	248	198 076 324	42	198 222 803	293	398 148 339	63
098 299 972	67-68,81	198 081 119	33	198 223 044	296	398 200 800	80
098 299 973	102	198 081 120	33	198 223 045	296	398 222 801	292
098 299 993	88	198 081 121	35	198 231 810	80	398 222 803	293
098 299 996	88	198 081 122	35	198 294 442	134	398 231 810	80
098 299 997	88	198 081 161	37	198 294 523	135	40 157 001	260
098 400 020	122-123,130	198 081 261	37	298 018 206	18	68 2407 027	183,210-211
099 110 006	7,61-62,66-67	198 081 317	32	298 018 207	18	68 2408 027	183,210-211
	78,252,256,295	198 081 318	32	298 018 210	18	898 241 005	319
099 110 010	254,296-297	198 081 319	36	298 018 211	18	898 241 010	319
099 110 019	20,118,250,258	198 081 320	36	298 018 347	16	898 241 015	319
099 110 049	113	198 081 321	34	298 018 348	16	898 241 020	319
099 110 051	9-10,56-57	198 081 322	34	298 018 351	17	898 241 025	319
099 110 129	57-61,280	198 081 330	40	298 018 352	17	898 241 030	319
	282-283	198 081 331	40	298 055 315	10	910 122 110	50
099 110 151	147	198 081 332	39	298 055 316	10	910 122 130	50
099 110 378	279,284-286,289	198 081 333	39	298 055 613	20	910 212 240	151
099 110 386	70-71	198 081 338	39-40	298 055 614	20	910 212 500	185
099 110 469	296,298	198 081 339	39-40	298 081 161	37	910 212 501	185
099 110 618	6-7	198 081 361	38	298 081 261	37	910 212 510	186
099 110 619	120,137	198 081 461	38	298 081 330	40	910 212 511	186
099 110 620	31-38,41-46,298	198 083 001	11	298 081 331	40	910 212 520	187
099 110 624	250	198 083 002	11	298 081 336	39	910 212 521	187
099 110 629	142,148-149	198 083 007	12	298 081 337	39	910 213 050	125
099 110 635	257,289	198 083 008	12	298 081 361	38	910 213 051	125
099 110 636	97,286	198 103 110	21	298 081 461	38	910 215 900	189
099 110 647	113,116	198 103 120	21	298 081 500	41	910 215 901	189



Art.-Nr. / Part No.	Seite / page
910 215 910	209
910 215 920	190
910 215 921	190
910 221 826	256
910 221 827	254
910 222 120	103
910 222 122	103
910 222 603	291
910 222 604	291
910 222 804	290
910 222 806	290
910 222 807	294
910 236 222	87
910 236 223	87
910 290 707	312-313
910 292 125	103
910 292 500	185-186
910 292 501	185-186
910 292 510	187
910 292 511	187
910 292 778	180,182-183 185-187, 189-190 209-211
910 292 779	180,182-183 185-187,189-190 209-211
998 254 160	217
j10.1002.100	174
j10.2070.110	212
j10.2070.120	212
j10.2070.140	212
j10.2070.160	212
j10.2300.002	173
j10.2600.002	163
j10.2600.502	163
j10.6014.121	176
j10.6025.110	172
j10.6025.120	172
j11.1001.001	91
j11.1010.100	83
j11.1010.805	83
j11.1011.150	83
j12.0014.020	316
j12.0014.300	316
j12.0015.000	316w
j12.0015.200	316
j12.0015.300	316
j12.0016.000	316
j12.1004.001	265
j12.1008.100	260
j12.1008.805	260
j12.1009.000	260
j12.1010.150	260
j12.1010.805	260
j13.3009.000	236
j13.4002.100	218
j13.4002.110	218
j13.4006.100	214
j19.0007.000	174
j19.2014.501	83
j19.6023.121	176
j19.6037.110	172
j19.6037.120	172
OSR64150CBI	348
OSR64151NBR	349
OSR64155TSP	348
OSR64156TSP	349

Zeichenerklärung / explanation of symbols

	ADR/GGVS Prüfung / ADR/GGVS approval
	E Prüfzeichen / E approval sign
	ohne Leuchtmittel / without illuminant
	mit Leuchtmittel / with illuminant
	Elektromagnetischeverträglichkeit / electromagnetic compatibility

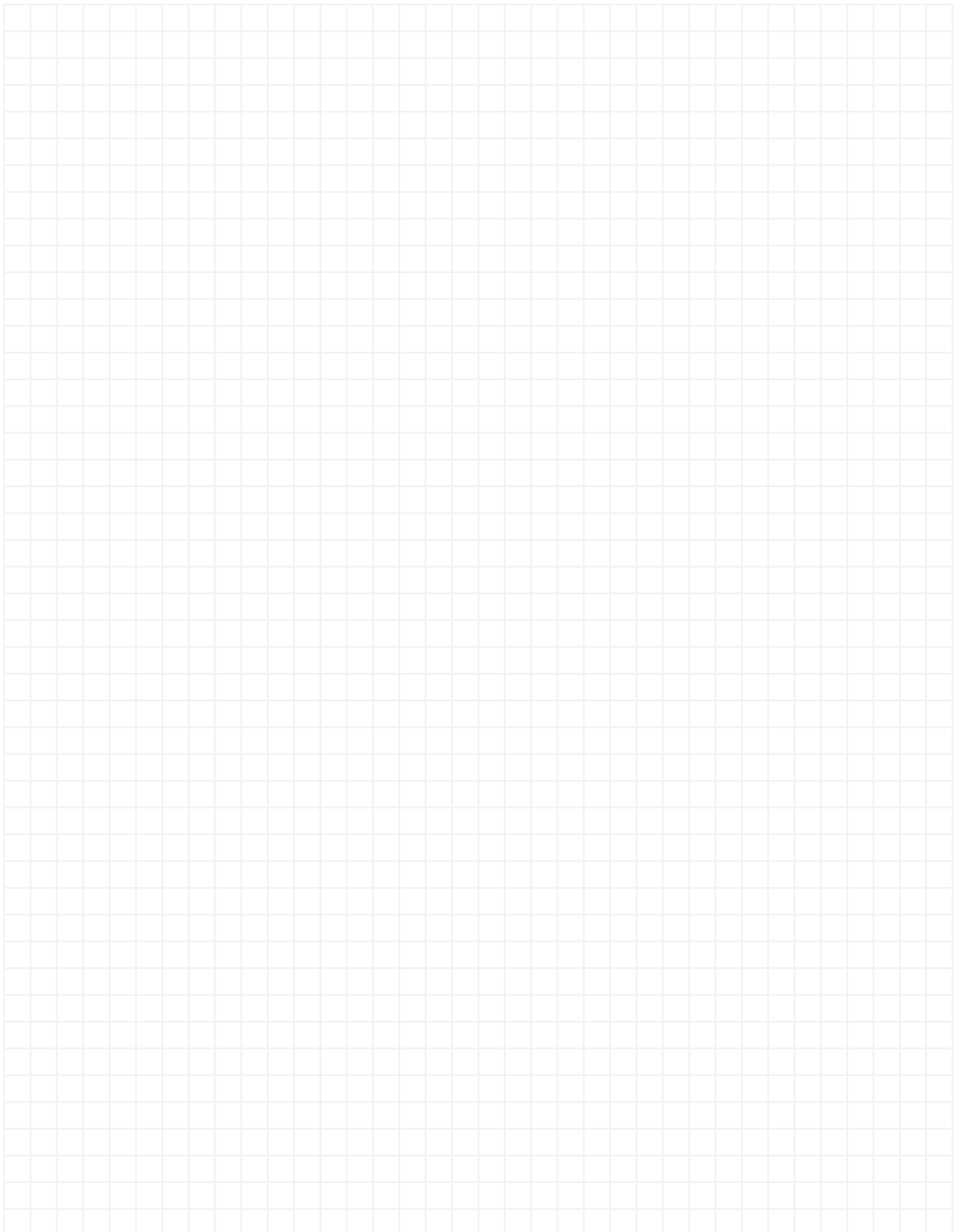

UNSERE KATALOGE

Informieren Sie sich über unser ganzes Sortiment in unseren **Detailkatalogen** oder im **Internet**

www.ral.at

www.fahrzeugbedarf.at



Fahrzeugausrüstung



Warn- und Arbeitsbeleuchtung



Nutzfahrzeuge

Download	Version	Größe
Altec Aufbaubi-Rangeer und Aufbaufahrer		1.9 MB
Altec Verlebaufkleber		19.6 MB
Altec Oberfläch-Behälter		142 K
BW Agri	BW	11.8 MB
BW Agri - Ersatzteile	BW	2.7 MB
BW Ersatzhaltung CAT - Aufbau	BW	6.0 MB
BW Pfl - Ersatzteile	BW	5.3 MB
BW Pfl - Ersatzteile	BW	6.0 MB
Dakon	Dakon	5.7 MB
Dakon Ersatzteile	Dakon	2.1 MB
Dakon Reparatur	Dakon	2.8 MB
Dakon Verlebaufkleber	Dakon	1.9 MB
Fahrzeugbedarf MZ Katalog	BW - Fahrzeugbedarf	18 MB
Full-time Stahlbehälter		2.4 MB
Heaven Nutzfahrzeugtechnik	Heaven	2.8 MB

Aktuelles bei Fahrzeugbedarf



Wir gehen nächstes Jahr online!



Genießen Sie zukünftig die vielen Vorteile unseres Webshops.

- Über 10.000 Artikel inkl. Datenblätter, Produkt- und Preisübersicht
- Einkaufen bequem von Zuhause aus 24hours/7days
- Lieferung bis zur Haustür
- Einfache Navigation, Kategorisierung und Suchfunktion
- Auch für Ihr Mobilgerät optimiert
- Bestellungen einfach und schnell verwalten
 - Bestellübersicht vergangener Einkäufe
 - Rechnungsübersicht
 - Lieferzeitenübersicht



*solange der Vorrat reicht

www.fahrzeugbedarf.at/webshop

Erstklassige Beratung durch unsere kompetenten und freundlichen Fachberater!
Besuchen Sie uns an einem unserer Standorte ganz in Ihrer Nähe,
oder online unter **www.ral.at**

Unsere Standorte im Überblick

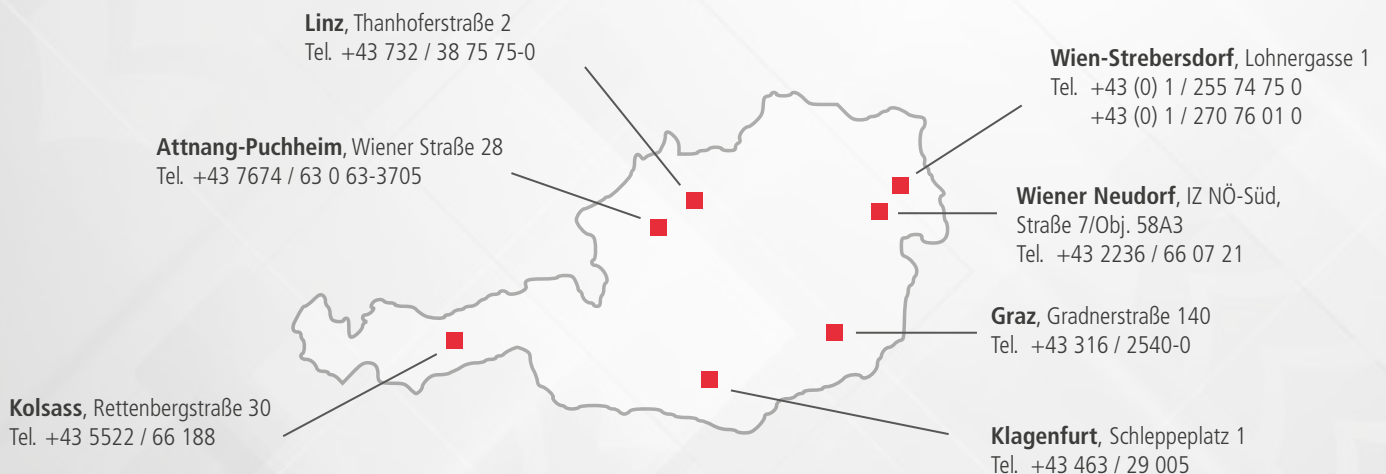

INFORMIEREN SIE SICH AUCH ÜBER UNSER WEITERES PRODUKTSORTIMENT IN UNSEREN KATALOGEN



NUTZFAHRZEUGE



WARN- UND ARBEITSBELEUCHTUNG



FAHRZEUGAUSRÜSTUNG